

JEWELRY

Making *and* Design

Rose and Cirino





JEWELRY MAKING *and* DESIGN

An illustrated text book
for Teachers, Students of Design, and
Craft Workers in Jewelry

BY

AUGUSTUS F. ROSE

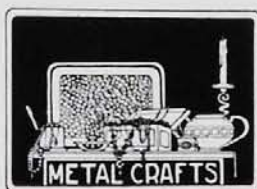
Author of "Copper Work"

Head of the Departments of Jewelry and Silversmithing,
and Normal Art, Rhode Island School of Design

and

ANTONIO CIRINO, B. S.

Assistant in Departments of Jewelry and Silversmithing,
and Normal Art, Rhode Island School of Design



METAL CRAFTS PUBLISHING CO.
PROVIDENCE, R. I.

Copyright 1917
By AUGUSTUS F. ROSE

Printed by
THE DAVIS PRESS, INC.
Worcester, Mass.

TABLE OF CONTENTS

Book I. Jewelry Making

CHAPTER		PAGE
I	Stones	11
II	Stone Cutting	22
III	Gold, Silver, and Weights	31
IV	Processes Involved in Jewelry Making	47
V	Brooches Pierced without Stones	49
VI	Brooches with Stones	59
VII	Brooches with Wire Edges	73
VIII	Brooches Carved and Ornaments Applied	77
IX	Brooches made of Wire	86
X	Brooches Chased and in Repoussé	97
XI	The Hat Pin	103
XII	Scarf Pin	109
XIII	Pendant	118
XIV	Finger Ring	142
XV	Cuff Links and Cuff Buttons	165
XVI	Fobs and Chains	169
XVII	Enameling	181
XVIII	Modeling and Casting	198
XIX	Hub and Die Cutting	214
XX	Equipment	234

Book II. Jewelry Design

CHAPTER		PAGE
XXI	Introduction to Jewelry Design	257
XXII	Jewelry Drawing	259
XXIII	Nature Drawing	265
XXIV	Historic Ornament	286
XXV	Principles of Jewelry Design	293
XXVI	The Beginning of Design (Variations)	305
XXVII	Structural Elements of the Circle	315
XXVIII	The Evolution of Design	319
XXIX	Geometric Designs	322
XXX	The First Problems in Design	330
XXXI	Rendering in Pencil	336

CHAPTER		PAGE
XXXII	Rendering with Brush	343
XXXIII	Rendering in Color	350
XXXIV	Rendering Stones	352
XXXV	The Vital Curves	356
XXXVI	How to Choose Material for Jewelry Design	362
XXXVII	Designs Derived from Nature	364
XXXVIII	The Moth-Mullen in Design	377
XXXIX	The Snow Crystal in Design	384
XL	The Sea Horse in Design	388
XLI	The Butterfly in Design	396
XLII	Designing the Elliptical Brooch	405
XLIII	Buckles, Clasps, and Bar Pins	408
XLIV	Pendants, Lavalliere, and Necklace	413
XLV	The Watch Fob	421
XLVI	The Hat Pin	426
XLVII	The Cuff Link and Cuff Button	430
XLVIII	The Finger Ring.	435
XLIX	The Scarf Pin	438
L	Chains, Pendant Slides, and Pendant Connections	441
LI	Keeping Freshness in One's Work.	450
LII	The Note Book	452
LIII	Equipment for Jewelry Drawing and Design	457
LIV	Jewelry Coloring	461

LIST OF ILLUSTRATIONS

Book I. Jewelry Making

PLATE		PAGE
	Pendants in Color	Frontispiece
I	Diamond Mine, South Africa	12
II	Stones in Color	
III	Stones in Color	
IV	Rana of Dolphur, "Prince of Pearls"	17
V	Pearling Fleet, Ceylon	19
VI	Australian Opals	23
VII	Slitting and Faceting Stones	24
VIII	Opal Jewelry	30
VIII-A	Pierced Brooches in Color	
IX	Pierced Brooches, (Designs)	48
X	Pierced Brooches	50
XI	Class in Jewelry Making	51
XII	Pierced Brooches	54
XIII	Designs for Circular Brooches	58
XIII-A	Designs for Elliptical Brooches	61
XIV	Brooches	66
XV	Stone Setting	71
XVI	Class of Teachers in Jewelry	76
XVII	Brooches	81
XVIII	Brooches	82
XIX	Designs for Wire Brooches	85
XX	Pendant in Wire	87
XXI	Brooches	90
XXII	Circular Brooches in Wire	93
XXIII	Hat Pin	104
XXIV	Scarf Pin	110
XXV	Scarf Pin	112
XXVI	Scarf Pin	114
XXVI-A	Scarf Pins	116
XXVII	Pendant	119
XXVIII	Pendant	121
XXIX	Wire Pendant	125
XXX	Designs for Wire Pendants	127
XXXI	Miscellaneous Jewelry	129
XXXII	Pendants in Wire	131

PLATE	PAGE
XXXIII	Pendant 133
XXXIII-A	Designs for Pierced Rings 141
XXXIV	Pierced Ring 143
XXXV	Pierced Ring 145
XXXVI	Wire Ring 148
XXXVII	Ring with Leaves 151
XXXVIII	Carved Cuff Links 167
XXXIX	Jewelry (Miscellaneous) 168
XL	Seal Fob 170
XLI	Seal Fob 172
XLII	Units for Chains 177
XLIII	Jewelry (Miscellaneous) 180
XLIV	Enameling Tools 184
XLV	Designs for Cloisonné Enamel 187
XLVI	Designs for Fobs in Enamel 191
XLVI-A	Enameled Brooches in Color
XLVII	Modeling and Cast Work 200
XLVIII	Casting (Opening Mould) 207
XLIX	Cuttle Fish Casting 211
L	Melting and Pouring 213
LI	Tools for Jewelry Making 238
LII	Locker Cabinet 240
LIII	Bench for Jewelry Making 244
LIV	Jewelry Room (East Boston High School) 245
LV	Demonstration Bench 246

FIGURE	PAGE
1	Stone Slitting 24
2	Faceting 24
3	Roughing out the stone 26
4	Cutting stone to size 26
5	Polishing stone 28
6	Rough and polished stone 28
7	Gold bars 34
8	California miners panning gold 35
9	Shaft mining (early method) 36
10	Pierced brooches without stones 49
11	Placing the saw through work 52
12	Fastening end of saw in frame 53
13	Method of holding work while sawing 53
14	Method of holding work while sawing 55
15	Method of holding work while sawing 55
16	Filing 55
17	Brooches with stones 59
18	Soldering 60

FIGURE

	PAGE
19 Borax slate	60
20 Cutting solder	62
21 Cutting solder (first cut)	63
22 Cutting solder (second cut)	63
23 Pickle pan	64
23-A Pickle pitcher	65
23-B Sand pad and lead block	67
24 Stone setting tools	69
25 Shellac Stick	70
26 Setting the stone	71
27 Trimming bezel.	71
28 Drilled Brooches	72
29 Brooches with wire edges	73
30 Brooches with wire edges	74
31 Pierced Brooches	74
32 Brooches with shot	75
33 Carved Brooches	77
34 Carved Brooches	77
35 Carved Brooches	78
36 Brooches with applied decoration	79
37 Square Brooch set with moonstones	79
38 Brooches	80
39 Brooches (miscellaneous)	83
40 Wire Brooches	68
41 Wire Pendant	86
42 Wire Brooches	88
43 Brooches in repoussé	89
44 Problems in wire bending	91
45 Brooches made up of natural elements	95
45-A Layout of design for circular brooch	96
46 Brooches chased and in repoussé	97
46-D Pitch Pot	98
46-E Chasing	99
47 Chased Brooches	100
48 Pierced Brooch with stones	101
49 Pierced Brooch with stones	101
50 Pierced Brooch with stones set	102
51 Hat Pin (pierced)	103
52 Hat Pin (chased)	107
53 Model for chased hat pin	107
54 Hat Pin Head on pitch block	108
55 Scarf Pin	109
56 Scarf Pins (miscellaneous)	111
58 Scarf Pin set with scarab	113
59 Scarf Pin with wire setting	117

FIGURE	PAGE
60	Pendant set with pearl 118
61	Pendants 122
62	Wire Pendants 124
63	Wire Pendants 126
64	Wire Pendant 126
65	Wire Pendant set with chrysacola 128
66	Wire Pendant 130
67	Wire Pendant set with garnets and pearls 132
68	Pendant set with pearl blister 132
69	Wire Pendant and chain 134
70	Details of pendant 135
71	Pendant with leaves and twisted wire 136
72	Pendants (miscellaneous) 136
73	Pendants (miscellaneous) 137
74	Wire Pendant with bell drops 137
75	Pendants (miscellaneous) 138
76	Pendant and chain units chased 139
77	Pendant on pitch 139
78	Pendant and units sawed to outline 140
79	Back of pendant 140
80	Pierced finger ring 142
81	Pierced rings 144
82	Rings (miscellaneous) 146
83	Wire Ring 147
84	Wire Ring with leaves and shot 149
85	Rings (miscellaneous) 152
86	Carved Rings 153
86-A	Rings (miscellaneous) 154
87	Carving Ring 154
88	Rings (miscellaneous) 155
89	Belcher Ring 155
90	Belcher Setting (details) 155
91	Belcher Setting (cutting seat) 156
91-A	Ring burrs 156
92	Belcher Setting (trying the stone) 157
93	" " (leveling the stone) 157
94	" " (setting the stone, first step) 158
95	" " (setting the stone, second step) 158
96	" " (filing the prongs) 159
97	" " (bright cutting) 159
98	Tiffany Setting 160
99	Tiffany Setting (details) 160
100	Gypsy Setting 161
101	Gypsy Setting (details) 162
102	Gypsy Setting (details) 162

FIGURE	PAGE
103 Gypsy Setting (finishing top)	163
104 Enameled Cuff Links	165
105 Cuff links (details)	166
106 Seal Fobs	173
107 Fob set with chrysacola	174
108 Fob (beetle design)	175
109 Muff chain set with turquoise	176
110 Chain made of wire units	178
111 Chain with moonstone beads and wire units	178
112 Neck chain with garnets	179
113 Jewelry making (class)	179
114 Enameled Jewelry	182
115 Grinding enamel	185
116 Porcelain mortar and pestle	186
117 Agate mortar and pestle	186
118 Charging enamel	190
119 Enameled Fob	192
120 Enameled Bracelet	194
121 Set of Enamels (12 colors)	195
122 Stoning enamel	196
123 Modeling Tools	198
124 Scroll (modeled)	199
125 Scroll (first step)	199
126 Modeling and Casts	200
127 Modeling Scroll.	200
128 Scroll (second step)	201
129 Scroll (third step)	202
131 Casting (preparing the mould)	204
132 Casting (pouring)	205
133 Casting (separating the mould)	206
134 Casting (trimming the mould)	207
135 Cast and mould separated	207
136 Touching up cast	208
137 Cuttle Fish casting	210
138 Lifting pattern from cuttle fish	211
139 Depression in cuttle fish	211
140 Opening for metal	212
141 Cuttle Fish casting (rings)	213
142 Melting and Pouring	213
143 Hub and Die Cutting	214
144 Hub	215
145 Method of laying out and cutting hubs	217
146 Hubs and Dies	219
147 Types of Dies	222
148 Hub and Die of ring	224

FIGURE	PAGE
148-A Drop-press	226
149 Die Ball	230
150 Chisels	231
151 Riffles	232
152 Plan of room for jewelry	234
153 Plan of room for jewelry	235
154 Benches for jewelry	236
155 Locker Cabinet	237
156 Individual Equipment	239
157 Ring Sizes	241
158 Surface Plate	241
159 Ring Arbors	241
160 Gauge Plate	241
161 Draw Tongs	241
162 Bench Brush, Polishing Sticks, Ring Clamp	242
163 Burnisher, Scraper, Scratch-awl, Punch	242
165 Draw Plates	242
166 Elevation of Locker Cabinet	243
167 Storage Cabinet	243
168 Design Table	247
169 Storage Cabinet (Books and Plates)	247
170 Polishing Bench	248
171 Flat Roll	249
172 Polishing Head	250
173 Sawdust Box	250
174 Screw Press, Kick Press	251
175 Annealing and Soldering Pan	251
176 Pickle Tank	252
177 Sand Blast	252
178 Coloring Outfit	253
179 Blower	253
180 Electric Drill	254

Book II. Jewelry Design

PLATE	PAGE
LVI Copy of Door-Knocker	263
LVII Flower Spray	266
LVII-A Study of Apple Blossoms	267
LVIII Bud Forms	267
LIX Bud Forms	268
LX Bud Forms	269
LXI Bud Sections	270
LXII Sections of Seed Pods	271

PLATE		PAGE
LXIII	Leaf Outlines	272
LXIV	Studies from Peacock	273
LXV	Shells	275
LXVI	Arabic Door-Knockers	281
LXVI-A	Steps in Tracing	285
LXVII	Historic Rings	288
LXVIII	Historic Ornament	290
LXIX	Hungarian Necklace	291
LXX	Historic Ornament	292
LXXI	Designs Derived from Nature	295
LXXII	Brooches in Wire	298
LXXIII	Brooches in Wire	300
LXXIV	Circular Brooches	302
LXXV	Beginnings of Design	306
LXXVI	Variations	307
LXXVII	Variations of Gothic Motive	309
LXXVIII	Variations	311
LXXIX	Variations	312
LXXX	Variations	313
LXXXI	Structural Elements of Circle	316
LXXXII	Evolution of Design	320
LXXXIII	Geometric Constructions	324
LXXXIV	Geometric Constructions	325
LXXXV	Geometric Constructions	326
LXXXVI	Geometric Constructions	327
LXXXVII	Arrangements of Circles	328
LXXXVIII	Outlines on which Jewelry is based	329
LXXXIX	Circular Designs	331
XC	Circular Designs	333
XCI	Circular Designs	334
XCII	Circular Designs	335
XCIII	Copies from Photographs	337
XCIV	Method of Rendering	341
XCV	Rendering in Two Values	344
XCVI	Rendering in Four Values on Gray Paper	347
XCVII	Rendering in Four Values on Gray Paper	348
XCVIII	Rendering in Color (Many Values)	
XCIX	Rendering Stones	353
C	Designs showing Vital Curves	358
CI	Designs derived from Verbena	365
CII	Suggestive Forms, from Beetle	367
CIII	Study of Bachelor's Button	368
CIV	Idea derived from Hollyhock	370
CV	The Bunchberry in Design	371
CVI	Designs derived from Insect	373

PLATE		PAGE
CVII	Designs derived from Tendril	375
CVIII	Gold Pendant set with Turquoise and Pearl Drop	
CIX	Photograph of Moth-Mullen Spray	378
CX	Moth-Mullen in Design	380
CXI	Designs derived from Moth-Mullen	382
CXII	Designs derived from Snow-Crystal	
CXIII	Snow-Crystal Patterns	386
CXIV	Designs derived from Sea Horse	393
CXIV-A	Designs derived from Sea Horse	395
CXV	Butterflies	
CXVI	Collection of Butterflies	397
CXVII	Method of Designing, from Butterfly	399
CXVIII	Method of Designing, from Butterfly	400
CXIX	Studies from Butterfly	401
CXX	Designs derived from Butterfly	402
CXXI	Brooches in Gold and Enamel	
CXXII	Buckles, Clasps, Bar Pins	409
CXXIII	Designs for Buckles	410
CXXIV	Shoe Buckles	411
CXXV	Brooch and Pendant in Gold	
CXXVI	Structural Elements in Pendants	414
CXXVII	Pendant Designs	416
CXXVIII	Pendants in Platinum	418
CXXIX	Designs for Seal Fobs	422
CXXX	Fob in Enamel	423
CXXXI	Fob in Enamel	424
CXXXII	Hat Pin Designs	427
CXXXIII	Hat Pin Designs	429
CXXXIV	Cuff Links for Enamel	431
CXXXV	Cuff Links for Enamel	432
CXXXVI	Cuff Links for Enamel	434
CXXXVII	Designs in Platinum	
CXXXVIII	Scarf Pin Designs	439
CXXXIX	Bead arrangement in Chains	442
CXL	Chain Designs	443
CXLI	Chain Designs	445
CXLII	Pendant Slides	446
CXLIII	Pendant Connections	448
CXLIV	Museum Sketches	453
CXLV	Museum Sketches	454
CXLVI	Museum Sketches	455

FIGURE		PAGE
186	Renaissance Scroll from Cast	259
187 A, B	Copies from Japanese Sword-Guards	260
188	Copy of Metal-Plate	262
189	Butterfly and Fish	276
190	Japanese Crests	277
191	Japanese Sword-Guard, Cast, Escutcheon	278
192	Grill	279
193	Saracenic Ornament	279
194	Scrap-Book	283
195	Copy of Pendant from Deutsche Goldschmiede Zeitung	284
196	Rendering from Copies	287
197	Jewelry	304
198	Variations of Bird Design	308
199	Structural Elements of Circle	317
200	Rendering from Photograph on Gray Paper	346
201	Renaissance Iron Ornament	361
202	Sea Horse	388
203	Hat Pin with Sea Horse Motive	390
204	Clasps	408
205	Clasps	412
206	Wire Pendants	413
207	Pendant Designs	415
208	Pendant in Platinum	194
209	Hat Pin in Wire	426
210	Ring Designs	436
211	Scarf Pin	438
212	Scarf Pins	440
213	Scarf Pins	440
214	Chains and Beads	441
215	Equipment for Drawing and Design	459

Foreword

THE subject of jewelry is treated in this book from an educational standpoint, and is presented as a series of progressive lessons consecutively arranged from the simple to the complex. The authors have practiced the methods laid down in the book and have obtained satisfactory results. They have tried to present the subject in a way that will be helpful to those who are beginning the work and to suggest ideas for those who have passed beyond the amateur stage.

An abundance of illustrated material will be found, consisting of drawings, designs and photographs of finished work, executed by students of all ages, including the High School, the Art School and the Professional Craftsman.

The various materials and processes involved are described in detail, and the necessary equipment for individual or for school use is outlined and illustrated.

The numerous designs in the book are shown with the idea of leading the student to think and design for himself and not to copy. Deliberate copying checks the student's development and stunts his individuality.

The chapter on "Hub and Die Cutting" is included in this book to show the modern method of producing a piece of jewelry by machine, that the reader may understand the process, and not that he will attempt the cutting of a hub or die without some experience in steel work. It is hoped that this volume will be found especially helpful to students of jewelry, craftsmen and teachers who are applying design to various materials.

The author's thanks are due the following persons who have assisted in the successful completion of the book.

To Josephine Beane Rose, for untiring assistance in correcting the text and reading the proof.

To the Rhode Island School of Design, for the opportunity of developing the work treated in the book.

To past students whose drawings and designs are reproduced, especially to Stanley Price, who assisted in making the mechanical drawings.

To Mr. Frederick Forth, Mr. Walter Saunders, and Mr. Emil Sweitzer, for valuable information; Mrs. Josephine Hartwell Shaw for the originals on pages 138 and 433; Ostby & Barton Company of Providence, for many courtesies; Miss E. B. Hewitt, Margaret Morrison, Carnegie School, Pittsburgh, Pa., for original on page 129; Mr. M. E. Heiser, Queensland, Australia, for the originals on pages 23 and 30; Mr. William A. Heath, for assistance with the chapter on "Hub and Die Cutting"; Mr. F. E. Masselin, for assistance with the chapter on "Modelling and Casting"; Mr. F. P. Boland, for cuts used on pages 248, 252 and 253; Espositer & Company of New York, for the original on page 29; The Jewelers Circular of New York, for the use of the cut on page 17; Handy & Harmon of Bridgeport, Connecticut, for the tables on pages 39, 40, 41 and 42; Methuen & Company, Limited, of London, England, for permission to use the color plates on pages 12 and 14, and the cuts on page 24; Doubleday, Page & Company, New York, for permission to use the color plate on page 396; the Century Company of New York, for permission to use the illustrations from "The Book of the Pearl," pages 19 and 21.

Grateful acknowledgment is also due to the numerous writers of whose books and magazine articles I have made free use, to which references are made in the appropriate places.

Introduction

THE Making of Jewelry is an ancient art, and may be traced to a very remote period, not only by examples, of which there are many, but through ancient writings. Abundant examples of goldsmith's work have been found in Egyptian tombs dating as far back as the fifteenth century, B. C. The Bible has many references to the use of jewelry.

The goldsmith's craft, as practiced centuries ago, has many attractive features that may be adapted or applied to the craft work of the present time. The possibilities for the application of design are unlimited. With no other material can more satisfactory results be obtained in the finished piece of work than with that employed by the goldsmith. No other craft calls for such skill in the handling of the materials used, or so keen a sense of fine line and proportion in design.

The pieces of jewelry most prized by our museums to-day are those made centuries ago, where cleverness in design and workmanship were of much greater value than the material used.

Many craftsmen design in the material, feeling their way along without a drawing, but, as Benvenuto Cellini says, "Though many have practiced the art without making drawings, those who made their drawings first did the best work."

In school work we have our attention called very often to the work of architects, sculptors, painters and engineers, but mention is seldom made of those who have worked in metal, even though their work represents some of the finest moments in the history of mankind. Few know that Tubal Cain was the first

metal worker of whom we have any record, or that Bezaleel of the Tribe of Judah and Oholiab of the Tribe of Dan were the goldsmiths who made the sacred jewels and vessels for the tabernacle. The names of Mentor, Acrages, Stratonicus, Unichus, and Hecataeus are unknown to many, but these are the men who produced the superb Greek specimens in metal, many of which are now to be seen in our museums. During the middle ages, it was the custom for each of the kings of France to have his goldsmith. Gilbert Lorin was goldsmith to Charles the Seventh, Jehan Gallant to Charles the Eighth, and Henri to Louis the Twelfth. Few know that Benvenuto Cellini and Girlandio were unrivalled goldsmiths of the sixteenth century, or even that our own honored patriot, Paul Revere, was a worker in the precious metals.

Jewelry comprises various objects for personal adornment, rendered precious by their workmanship. In the form of rings and pendants, jewelry may be merely decorative, or in the form of brooches and pins, it may be useful as well. The making of jewelry cultivates an appreciation of this ancient art. To acquire the keenest sense of appreciation for the fine jewelry of ancient or modern times, one must study the designs as expressed in the work, and practice the art. The knowledge derived from actual practice is both cultural and practical. It not only helps to develop the artistic impulse and make the individual sensitive to the beauty of nature as applied to metal, but it also arouses interest in the metal industries and the commercial processes allied with the manufacture of jewelry on a large scale, such as mining, assaying and alloying.

BOOK I
JEWELRY MAKING

•••

Materials Used in Jewelry Making

Jewelry, generally speaking, is made up of stones either precious or semi-precious, and the metal that forms the setting. Before taking up the making of jewelry it is necessary that one should know something of the materials used. Chapters I and II take up the subject of stones used in jewelry and their cutting and polishing. Chapter III deals with the metals used, their alloys and methods of weighing.

Dem.
3 De Foe Place.
Providence
R. I. U.S.A.

Chapter I Stones

"Dumb jewels in their silent kind, more than quick words do move a woman's mind."

SHAKESPEARE

STONES have been worn upon the persons of men and women since prehistoric times and in most pieces of jewelry today, stones, because of their rarity and color, play the principal part, and are usually the central feature around which is the setting or ornamentation.

Generally speaking the stones used in jewelry are divided into two classes—Precious and Semi-Precious. These terms, however, are used commercially and refer to their rarity and value. The value of a stone is merely what it will bring in the open market and its artistic merits may be only a matter of opinion. Many people, however, prefer the rare to the beautiful.

These stones are no less than minerals taken from the earth, and after they have been improved by the art of man by cutting and polishing, the finest and rarest of them are what we call gems.

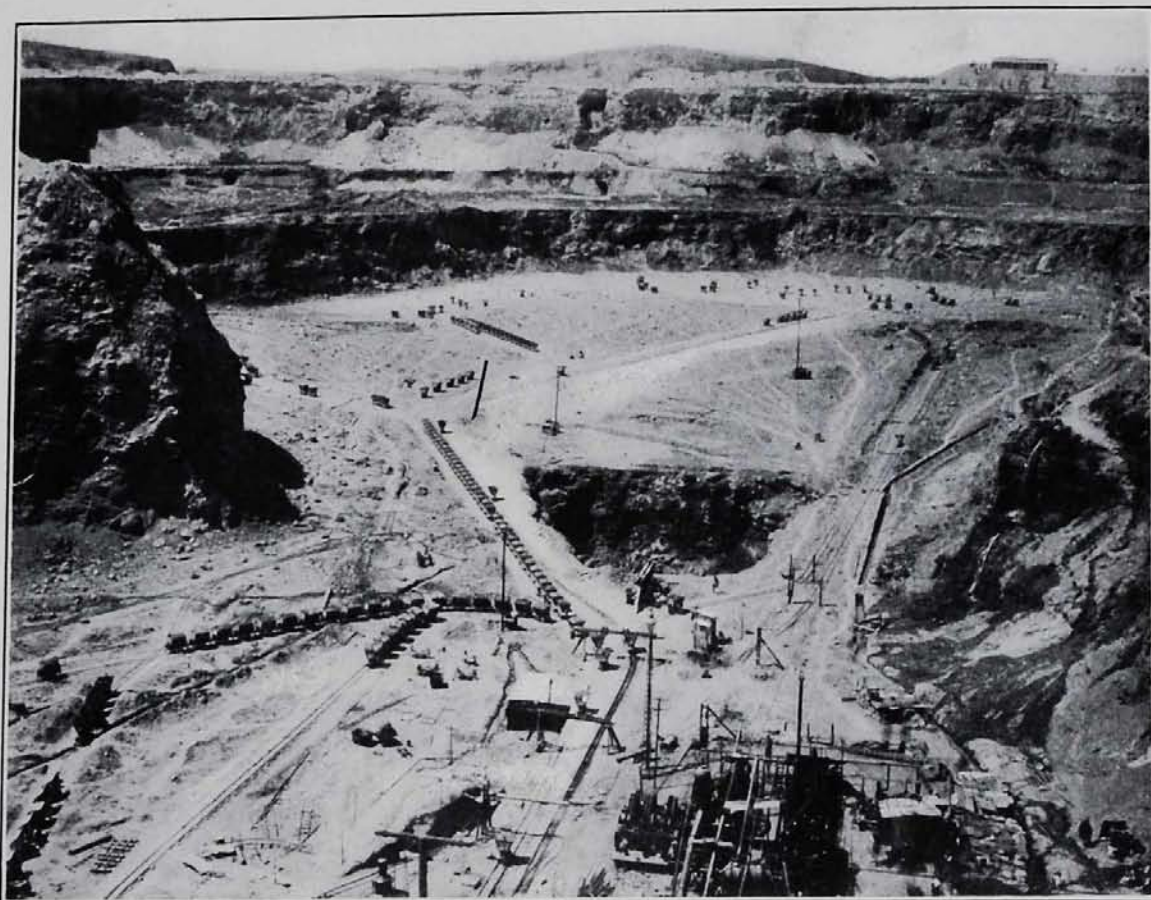
PRECIOUS STONES

The most precious stones are the diamonds, emeralds, rubies and sapphires. The pearl is oftentimes classed with precious stones. Although strictly speaking while it is not a stone it holds an honored place in jewelry.

DIAMOND

Diamonds were originally found in India but are now found in South Africa, Brazil and many other places. The diamond possesses more desirable qual-

PLATE I



Diamond Mine, South Africa



Compound where miners live



1. Diamond



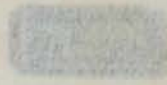
2. Diamond
(Crystal)



3. Diamond



4. Aquamarine



5. Emerald



6. Aquamarine



7. Topaz



8. Emerald
(Crystal in Matrix)



9. Topaz



10. Ruby
(Crystal)



11. Sapphire



12. Yellow Sapphire
(Oriental Topaz)



13. Ruby



14. Sapphire
(Crystal)



15. Star-Ruby



ities than any other stone, having greater hardness, brilliancy, light and refraction, and is found in a variety of colors, such as white, yellow, brown, blue, green and in many shades. It is found in deposits of gravel, sand or clay in river beds and is recovered by the simple process of washing.

EMERALD

The emerald is probably the rarest of all precious stones and is considered by some to be even more valuable than the diamond. Compared with other precious stones the emerald in its occurrence in nature is unique, for it is found in the rock in which it was formed. Unlike diamonds, sapphires and rubies, it never occurs in gem gravels. The earliest known locality where emeralds were found was in upper Egypt near the coast of the Red Sea. The best stones, however, are found in Columbia, South America. Fine specimens have also been found in the United States in North Carolina.

While the usual shade of color seen in emeralds is alluded to as emerald green, there are other shades, such as grass green, sea green and green slightly tinged with yellow. The shades most highly valued are those of an intense fresh green sometimes compared with that seen in a meadow in spring.

RUBY

The ruby is the oldest or first known of all precious stones, dating far back in the early history of Chaldea and Babylonia. The finest specimens, as well as the largest quantities, are found in Upper Burma, and at the present time over one-half of the world's supply comes from this locality. The rubies found in Ceylon, Siam and Australia have not the deep rich color of the Burmese ruby which is a shade of red slightly inclined to the purple and is often called "Pigeon Blood Ruby." The value of rubies depends upon their color and transparency.

The ruby is found in limestone deposits on side hills, but the largest quantity is found in alluvial deposits of gravel and clay in river beds. These deposits are about fifteen to twenty feet below the surface and from a few inches to five feet in thickness. This material called "byon" is mined or removed and put through a washing process by which the rubies are recovered.

The genuine ruby is gotten from the mineral known as corundum. Emery, so much used, is an impure form of corundum.

The superbly blood-red color of the perfect ruby is produced by the very tiny portions of impurity in the substance after they have been crystalized by Nature's wonderful processes.

All genuine—that is natural stones, contain certain tiny flaws and blemishes and characteristic peculiarities. The fewer these flaws the rarer the gem.

Imitation stones get their imperfections during manufacture, and as the chemists are more careful than Nature, these imperfections are less noticeable.

By the following differences between the real and the artificial, you can test your ruby.

A real ruby contains irregularly shaped bubbles; the imitation ruby contains bubbles that are perfectly round.

Natural rubies all have a silky sheen, due to a number of tiny parallel lines going in three definite directions; imitation stones never have this characteristic.

To examine a ruby, place it in a strong light and look at it through a microscope. If the stone is in a setting, then place a drop of oil on its face and hold it up with the back to the light. When it is held in this way the stone is illuminated and can be thoroughly examined through the lens. The drop of oil prevents reflection that would hinder the eye.

Rubies are over four times heavier than water. If you take the right quantity of water and dissolve in



1. Rubellite



2. Tourmaline



3. Balas-Ruby



4. Blue Spinel



5. Quartz



6. White Opal



7. Amethyst



8. Tourmaline



9. Black Opal



10. Fire Opal



11. Alexandrite
(By daylight)



12. Chrysoberyl



13. Alexandrite
(By Artificial Light)

The ruby is found in limestone deposits on side hills, but the largest quantity is found in alluvial deposits of gravel and clay in river beds. These deposits are about fifteen to twenty feet below the surface and from a few inches to five feet in thickness. This material called "byon" is mined or removed and put through a washing process by which the rubies are recovered.

The genuine ruby is gotten from the mineral known as corundum. Emery, so much used, is an impure form of corundum.

The superbly blood-red color of the perfect ruby is produced by the very tiny portions of impurity in the substance after they have been crystalized by Nature's wonderful power.

All genuine—that is natural stones, contain certain tiny flaws and blemishes and characteristic peculiarities. The fewer these flaws the rarer the gem.

Imitation stones get their imperfections during manufacture, and as the chemists are more careful than Nature, these imperfections are less noticeable.

By the following differences between the real and the artificial, you can test your ruby.

A real ruby contains irregularly shaped bubbles; the imitation ruby contains bubbles that are perfectly round.

Natural rubies all have a silky sheen, due to a number of tiny parallel lines going in three definite directions; imitation stones never have this characteristic.

To examine a ruby, place it in a strong light and look at it through a microscope. If the stone is in a setting, then place a drop of oil on its face and hold it up with the back to the light. When it is held in this way the stone is illuminated and can be thoroughly examined through the lens. The drop of oil prevents reflection that would hinder the eye.

There are over four times heavier than water. If you take the right quantity of water and dissolve in



it thallium, silver nitrate, you get a liquid four times heavier than water. If a ruby sinks in this it is a normal stone; if not, it is imitation.

SAPPHIRE

The word "sapphire" which means blue, is of the same form in nearly all the early tongues, thus showing that they were in use by the ancients. Sapphires are found in many parts of the world and are usually found in the same locality as the ruby. The largest number and finest quality of these stones come from Siam, and are found and recovered in much the same way as the ruby.

The sapphire is next to the diamond in hardness and it is this quality that makes it impervious to wear and insures its sharp edges and corners against years of use. Like the ruby the value of the sapphire is determined by its color. The finest stones are a deep blue and the deeper the color the more highly it is prized if its translucency is not impaired. Although the sapphire with its many shades of blue is considered the most desirable stone, it is also found in other colors such as red, green, yellow and pink.

PEARL

*"Errors, like straws, upon the surface flow,
He who would search for pearls must dive below."*

DRYDEN.

On account of their natural beauty pearls have been considered from the earliest times as among the most splendid gems.

The people of India and Persia were among the earliest to collect pearls, because of the rich fisheries of Ceylon and the Persian Gulf. The Indian and Persian princes have been enabled to acquire large collections of pearls which have never been equalled. Some of these princes have pearls and pearl ornaments worth millions of dollars.

The late Rana of Dholpur, sometimes called the "Prince of Pearls," possessed a collection of pearls unrivaled by those of any of the other Indian princes. The portrait, Plate IV, shows the pearls in about one-fortieth their actual size and with this fact in mind, an idea of the value of the jewels may be obtained from the illustration. It is reported that the Prince had an offer of \$1,000,000 for the string of single pearls which is shown encircling his neck. These pearls are of unusual size and of perfect luster. The offer, it is said, was not considered, as it is against all tradition for a native of India to part with jewels of this kind. The entire collection of this Prince is said by experts to be valued at over \$7,000,000.

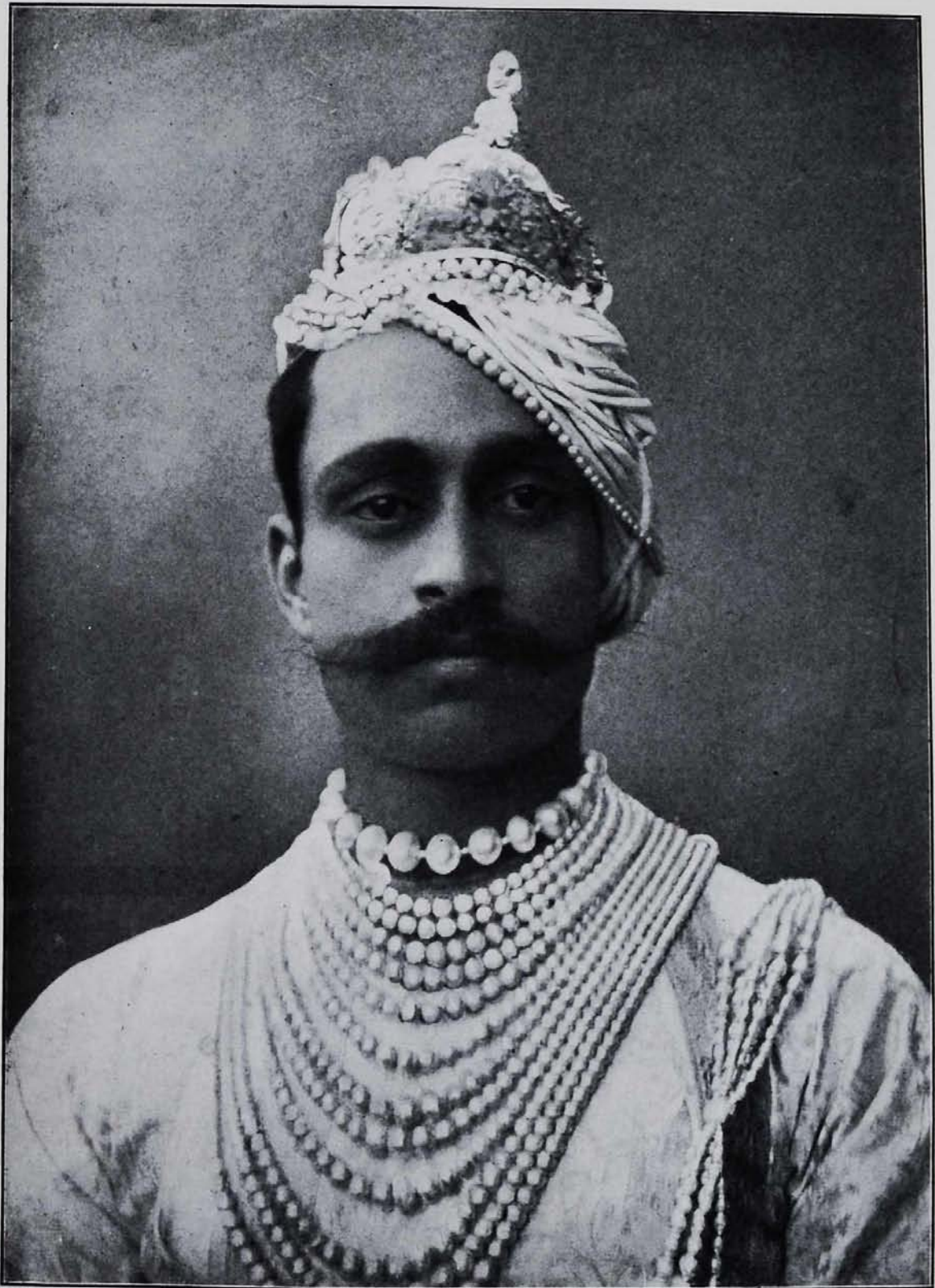
The finest quality of pearls are produced by the pearl mollusk, which inhabits the seas and rivers of temperate regions. This bivalve mollusk has a shell from two to eight inches in diameter and is grouped like the common oyster in colonies.

Pearl fishing has been carried on in Ceylon since 550 B. C., and is conducted much the same today as it was then. Dr. George F. King in "The Book of the Pearl," gives a most interesting description of the pearl fisheries of Ceylon which is here very briefly described.

These fisheries are under the control of the colonial government of the British Empire who operate them on its own account, allowing the fishermen one-fourth of the oysters taken by them and selling the remaining three-fourths.

When it has been decided to hold a fishery, public notice is given by advertisement stating the time of beginning, the length of time it will last, the reefs to be fished, the number of boats to be given employment and an estimate of the number of oysters to be removed.

The fishery usually begins late in February as the sea is then relatively calm and there is less danger of storms. A week before the opening of the season the



Rana of Dholpur, "Prince of Pearls"

boats begin to arrive from India, Arabia and elsewhere. Sometimes fifty or more come in a single day, laden with men, women and children, some with the materials for their huts. It is only a few days before the desolate beach becomes populated with thousands of people. Besides the eight or ten thousand fishermen, there are pearl merchants, government officials, provision dealers, pawn dealers, mechanics, clerks and priests—the whole making up a city of about forty thousand or more with well planned and lighted streets, a police court, a jail, a bank, post auction room, hospital and cemetery, all for a strenuous six weeks of toil and labor of money getting and gambling.

The fishing fleet consists of several hundred boats which are examined by the officials and, if found satisfactory, are registered and numbered. The average boat carries about thirty-five men. Arising shortly after midnight they prepare to get under way so as to reach the reefs about sunrise. There each boat takes its position assigned for the day and the divers begin working in pairs. The number of oysters secured on each visit to the bottom is on an average between fifteen and fifty. The diving is continued until a signal is given from the guard vessel when the boats go ashore. After the boats are run up on the beach the oysters are removed and placed in the government palisades, which is all done under close supervision. The oysters are then divided and after the fisherman receives his share the rest are auctioned off and bid in by the pearl merchants. The purchaser then opens the oysters and carefully searches for the pearl. Machines are now used in recovering the pearls. After the six weeks of strenuous work the fishermen fold their tents and silently steal away until another season comes around. In 1906 in Ceylon and India, pearls were gathered to the value of \$1,300,000.

Pearls are met with in almost every color of the rainbow, but those with a rich warm tint are most in demand. The lustre, as it is called, is its chief char-



The pearling fleet on the shore at Marichchikadde, Ceylon



Unloading oysters from the vessels at Marichchikadde, Ceylon

acteristic and when combined with the right color, makes it beautiful and valuable.

Pearls are sold by their weight in grains rather than by karats, four grains being equal to one karat. As in the case of precious stones the value of pearls varies with their size, form and general appearance. A first-class pearl must have a symmetrical form, a smooth surface and a perfect lustre.

SEMI-PRECIOUS STONES

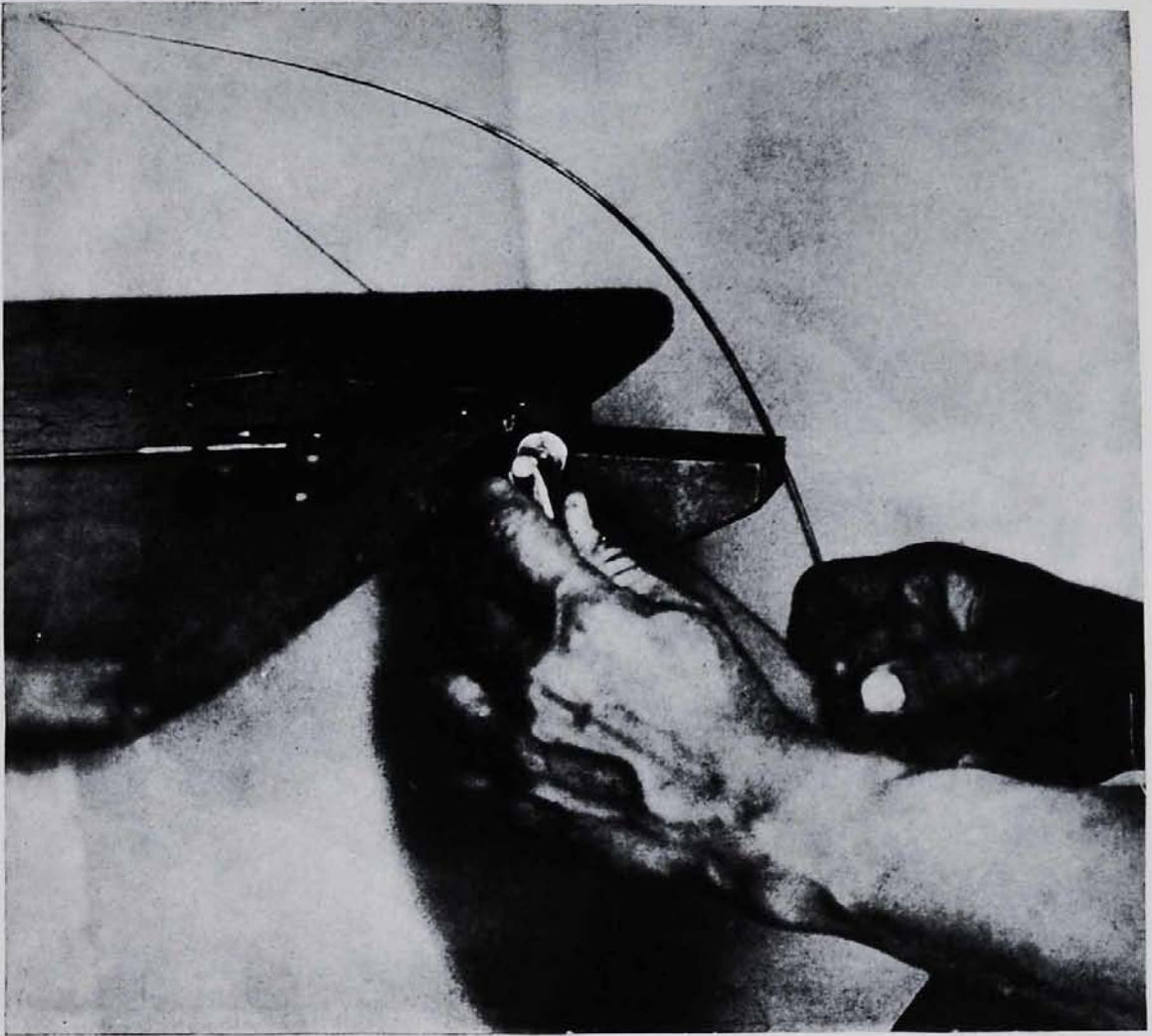
A large number of stones used in jewelry are known as semi-precious; the most important ones are as follows:—

amethyst	peridot
lapis-lazuli	opal
turquoise	tourmaline
aquamarine	zircon*
topaz	chrysoberyl
moonstone	alexandrite

Others of less importance although much used are:—

chrysoprase	azurite
jade	malachite
garnet	bloodstone
agate	coral
carnelian	

and many others. These stones while comparatively common and inexpensive, are indispensable to the worker in jewelry. The variety of colors to be had in these stones make it possible to produce unusual designs of artistic merit and to adapt them to the personality and costume of the wearer. For more detailed information regarding stones the student is referred to "Gem Stones" by G. F. Herbert Smith, also "The Curious Lore of Precious Stones," by George Frederick Kunz.



Drilling pearls

To become acquainted with stones, in addition to reading about them, it is necessary to see and handle them in order to know their peculiar characteristics. Most Natural History Museums have collections of Gem Minerals which show the relation of the rough material to the cut gems, the characteristic colors and variations of color, as well as the form of cutting mostly used in different kinds of jewelry.

The most satisfactory way of learning about stones is to make a private collection. By adding two or three from time to time and looking each one up in the numerous books on Mineralogy or Gems they become so fixed in the mind that they can be called by name and described at will.

Chapter II

Stone Cutting

WE have no record of the first genius who discovered that added beauty might be obtained by polishing, and thus adding lustre to color; nor of the genius who invented the art of drilling gems, so that they could be strung. The art of faceting only dated back to the 15th century when diamonds were introduced as personal ornaments, although in India large brilliants were polished on their natural facets, but these only added to the surface lustre, and had no relation to the laws of the incidence of light which govern the proportions of a modern diamond, cut scientifically to attain the maximum brilliancy.

The early stone cutters were organized into guilds, and records of these show that they existed as early as 1285 in Paris, Nuremburg and Bruges. The earliest form of cutting was probably nothing more than an attempt to adapt its outline to the form of setting designed for it by rounding off its corners and other irregularities.

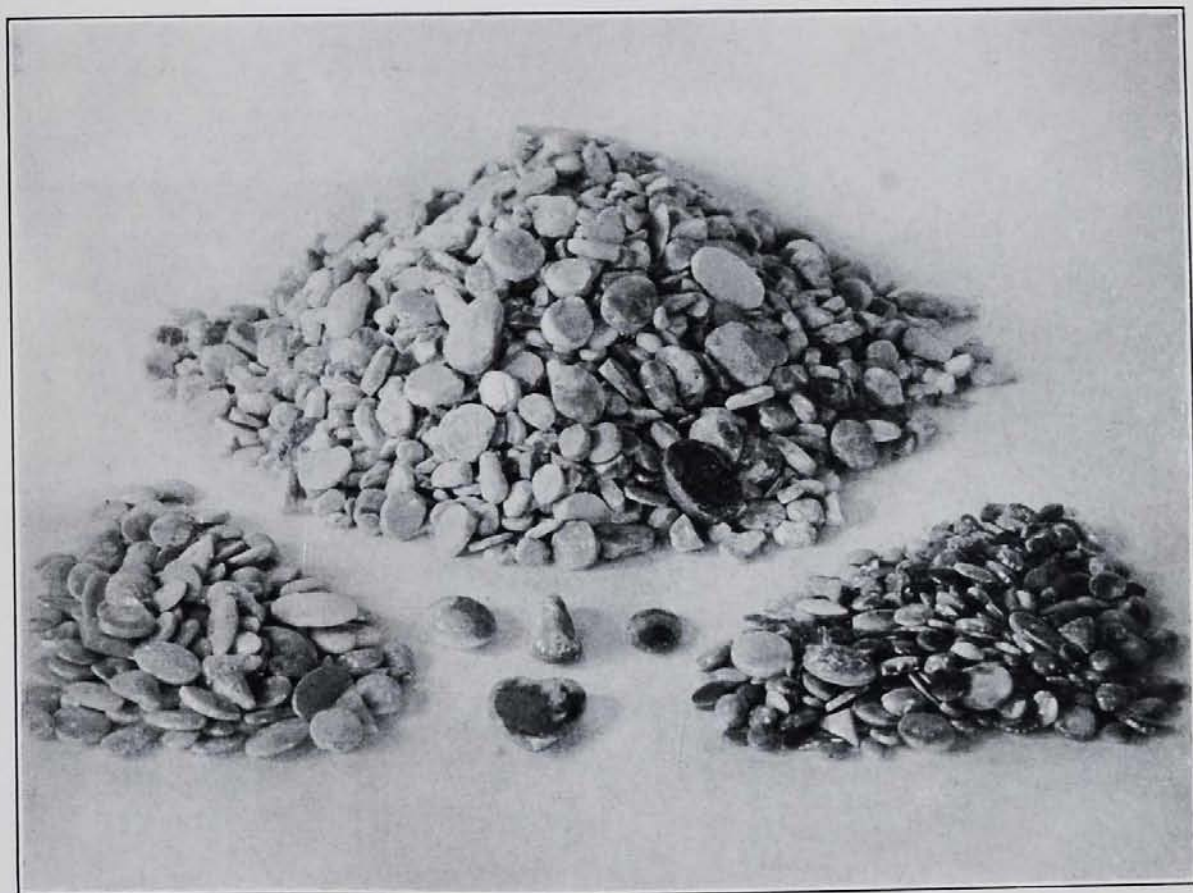
Ludwig Van Berguen of Bruges was the first man to cut diamonds with a symmetrical arrangement of facets. He tried the experiment of putting two diamonds in cement and rubbing one against the other, and found by doing this that the stones could be polished and even cut in any way he liked, thus adding to their brilliancy and value.

CUTTING DIAMONDS

There are four important stages in the cutting of diamonds—cleaving, slitting, cutting and polishing.



A pile of rough opal as it comes from the mine in Australia
Weighs 288 ounces and will cut 7,200 karats



The large pile in the background is rough cut opal
The stones in the foreground are cut and polished
The lot represents about \$7,000 worth of stones

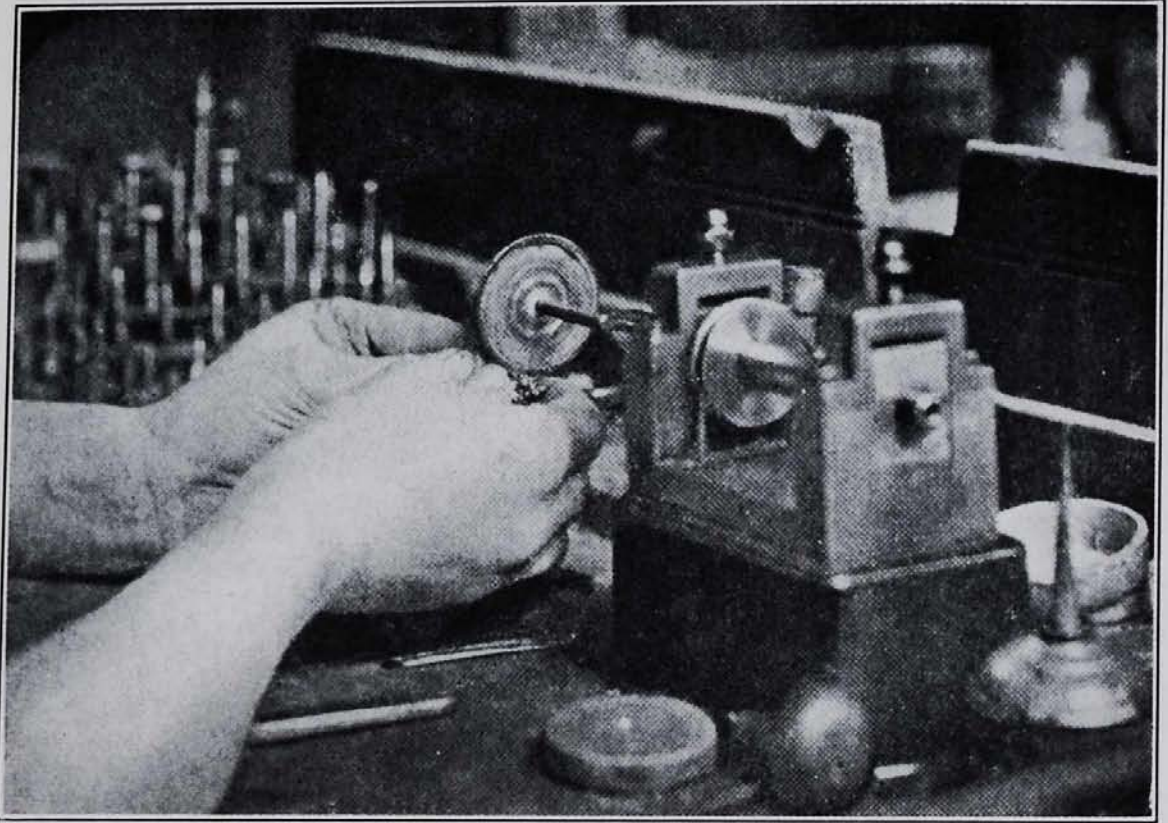


FIGURE 1. Slitting the stone

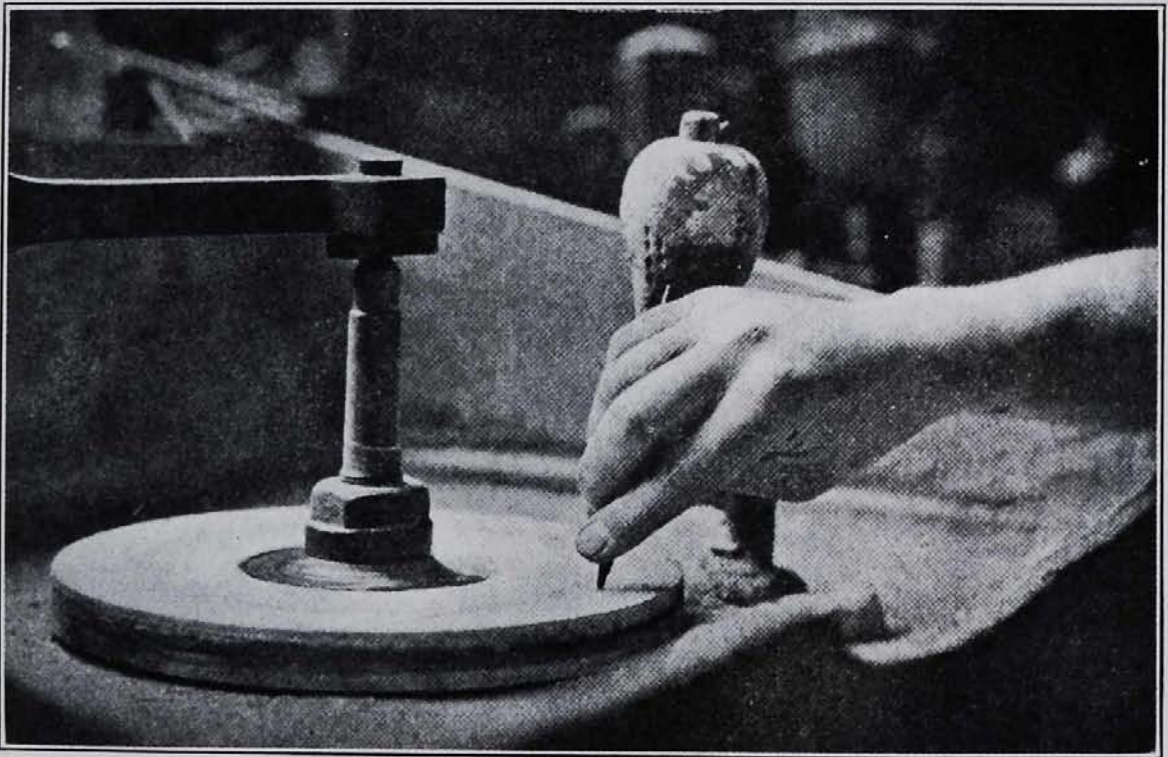


FIGURE 2. Faceting

Cleavage in a diamond is what is known in wood as "grain" and must be carefully studied in cutting them. The diamond to be cleaved has a small notch cut into it by the edge of another diamond, into which a steel blade is inserted and struck a quick blow, which splits the stone.

After being roughly formed by breaking off corners the stone is then cut and polished, which is only a mechanical process. The diamond is held next to a wheel which revolves at a high rate of speed and with the use of diamond dust and oil, facet after facet is formed. There are fifty-eight facets on every full cut brilliant diamond.

Through the courtesy of Mr. Frederick Forth, the author had the pleasure of spending a half day in the lapidary of Van Dam & Co., of Amsterdam, the largest diamond cutting house in the world. Here there were about three hundred men employed; diamonds were being cut and handled in large quantities.

The cutting of diamonds is an art by itself and the lapidary who cuts and polishes diamonds rarely cuts other stones. In cutting the diamond, brilliancy is the prime requisite, while in cutting other stones, color is given precedence.

STYLES IN STONE CUTTING

There are five styles of stone cutting that have been practiced for a long time which are as follows: Cabochon, Table cut, Rose cut, Brilliant cut and Step or Trap cut.

The oldest of these styles of cutting is the rounded shape known as cabochon which was used in the cutting of rubies, emeralds, sapphires and garnets until the modern methods of cutting came into practice. These stones as well as all transparent ones are now cut with facets.

CUTTING SEMI-PRECIOUS STONES

Opaque and semi-opaque stones are now cut cabochon, and although the finest cuttings require experience,



FIGURE 3

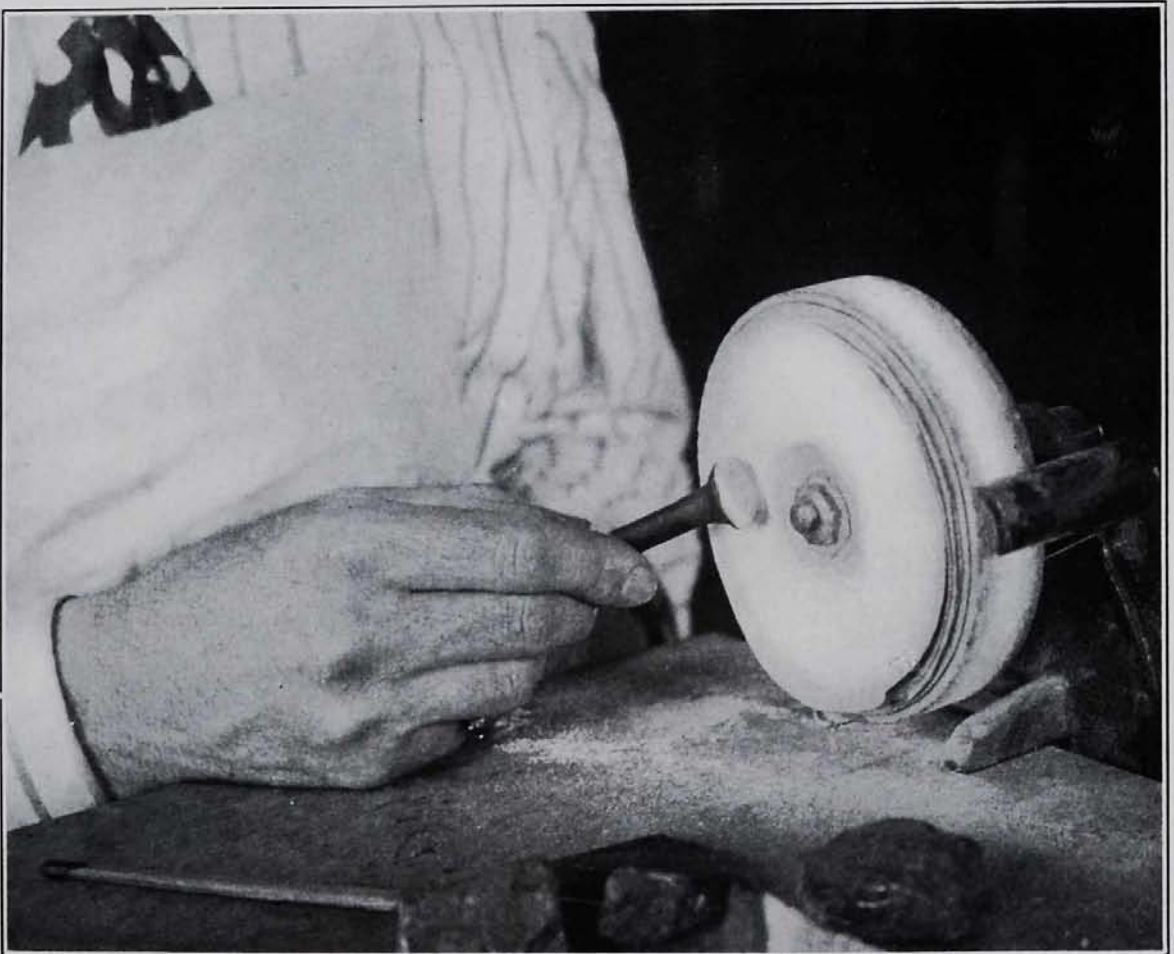


FIGURE 4

the amateur will be surprised to find that with a very limited equipment he is able to do creditable cutting.

SLITTING

A piece of rough stone is taken and first closely examined, to determine the best method of cutting in order to get the greatest value with the least waste and loss of weight. Having decided the best method of cutting it is then put through a process of "slitting," Fig. 1, if it is a large piece. The rough stone is held against the edge of a thin metal disc or circular plate and while it is revolving at a high rate of speed, fine emery and oil is applied to hasten the process.

ROUGHING

After the large piece has been slit up into pieces of the required size and thickness, one of the pieces is held with the fingers against a corundum wheel and roughed into shape. The face which is to be the front of the stone is then fastened to the end of a holder (an ordinary pen holder will do) with cement, which is easily heated over the gas or alcohol lamp.

POLISHING

If a wheel similar to the one shown in Fig. 3, is used, a few discs of No. 000 sand paper may be fastened to the side for the finer cutting and polishing. The stone is now held next to the revolving sand paper disc, Figs. 4 and 5, and cut to the required shape. It will be found that the cutting wears away the sand paper leaving it quite smooth, which is just the surface needed for the polishing. Continuing to hold the stone against the smooth paper with the aid of the powder that has already adhered to the wheel, the stone is given the required polish. Unless it is desired to have a perfectly flat back the stone is given a slight rocking motion during the polishing process. To give the final finish to the stone it is held against a buff with a little putty powder or oxide of tin.



FIGURE 5

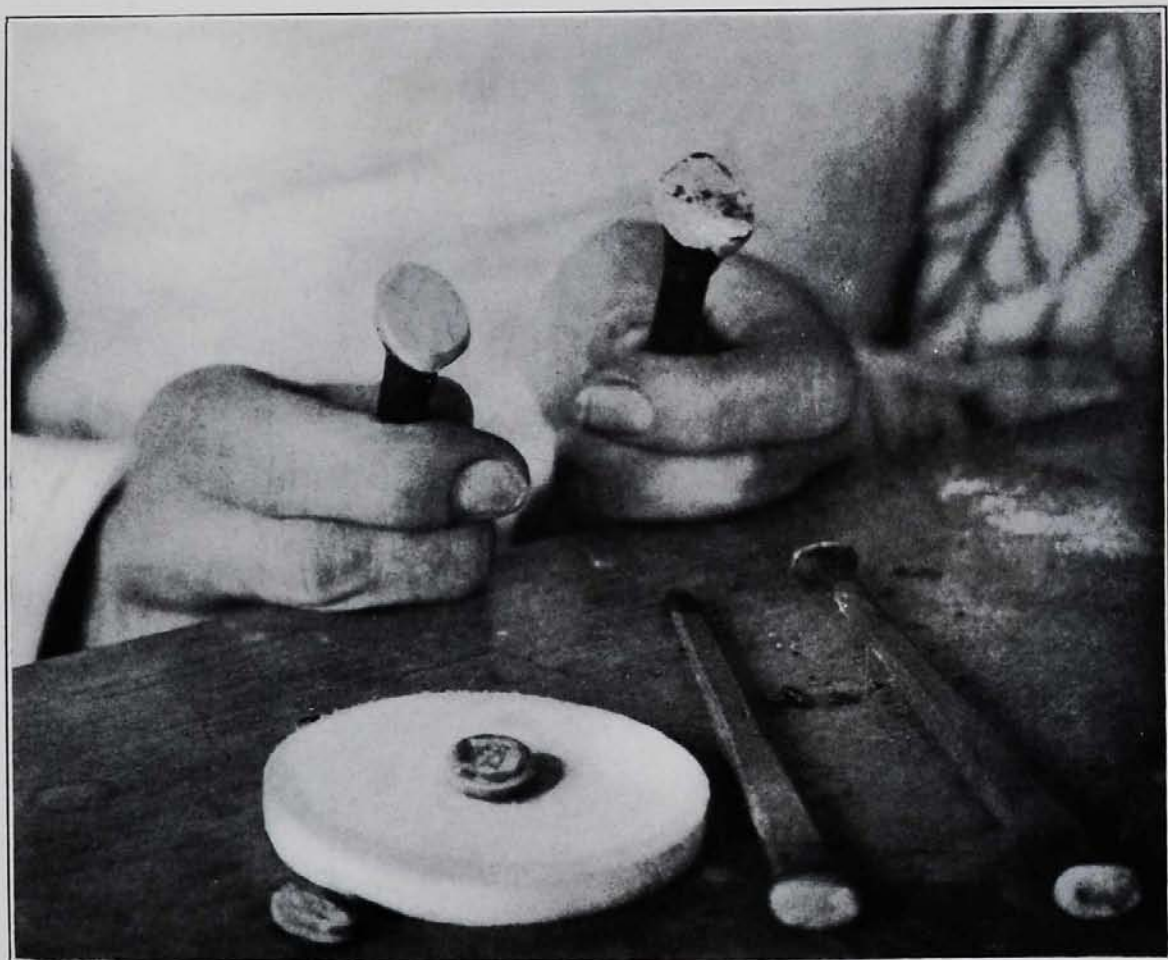


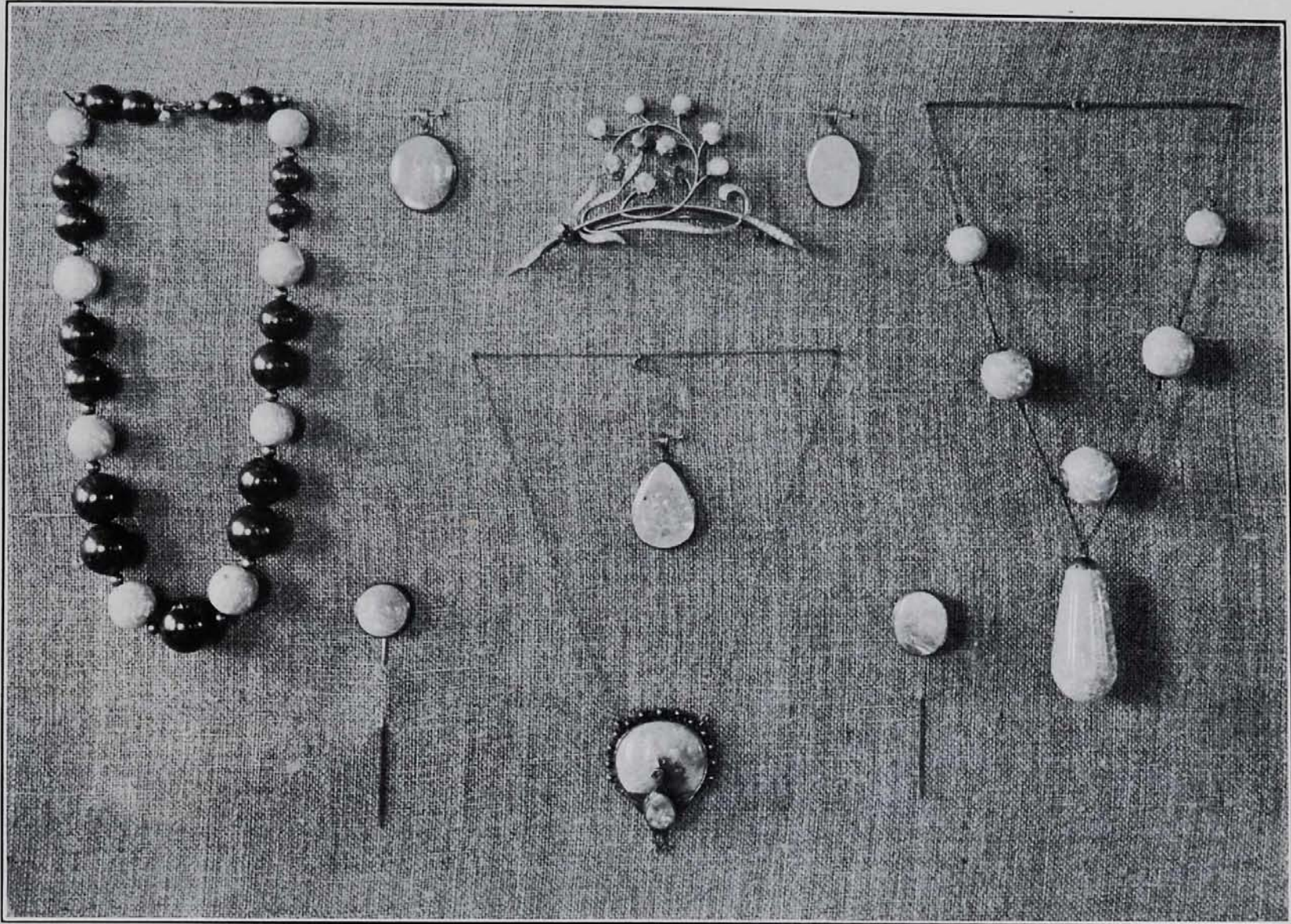
FIGURE 6 Showing stone in the rough and polished

After the back is completed the stone is removed from the stick with the blade of a knife, but in doing so care must be exercised so as not to chip the stone. The cement is now warmed again and the stone fastened to it, having the face or front of the stone at the top. The cutting is done as before except that the front of the stone is usually rounded more or less which gives it the cut styled cabochon. An ordinary grindstone may be used for the rough cutting and where several stones are to be cut the same size, grooves are made in the grindstone for this purpose.

Some of the semi-precious gem minerals may be obtained for a few cents an ounce and where the craftsman can do his own cutting he is able to save money on his stones, and oftentimes get results that are distinctive in every way.



An up-to-date lapidary



The opals shown here weigh 514 karats and are valued at over \$2,500. They are about one-fourth full size

Chapter III

Gold-Silver-Weights, etc.

GOLD

GOLD is one of the metals taken from the earth and is probably the first metal known to man. Its first use has been traced back to 3600 B. C. and was probably originally obtained in Egypt, as the ancient methods of obtaining gold in Egypt are illustrated in early rock carvings. It is said in the book of Genesis that Abraham, in the twentieth century B. C., when he went out of Egypt, was very rich not only in cattle but in gold and silver both in dust and ingots. In Exodus xxv, 29, we read that Moses was commanded by the Lord to make spoons of gold for the Tabernacle. In the writings of Homer, Sophocles, Herodotus, Pliny and others, gold is frequently mentioned.

Gold is widely distributed in nature and is found in many ways and in all parts of the world. It is found in water, in the ice of Alaska, in the sand of South Africa, and in the quartz in Colorado, and is frequently found native, though usually alloyed with silver or iron. The purest specimens of native gold have yielded from 96 to 99 per cent. pure metal.

The unanimity with which all races of mankind have selected gold as the first and chief representative of value is remarkable. In the earliest times it was used as a medium of exchange in the form of bars, spikes and rings; the rings could be opened and closed so that a chain could be made for convenience in carrying. Gold was also used at a very early period for the construction of personal ornaments, as the savage

found it easy to beat out the pure ore into circlets to adorn his limbs. The universal use of gold in preference to all other metals is due to its many properties; its color and lustre, its malleability and its indestructibility. Gold does not tarnish nor can it be destroyed. It may be reduced to a liquid and the liquid transferred to a powder, and the powder when melted in a crucible returns to its natural state. It is the most malleable of all metals and has been hammered into leaves 1-282,000th of an inch thick. An ounce of gold may be drawn out into a wire fifty miles long. The tenacity of gold is seven tons per square inch.

Pure gold, being too soft for all ordinary purposes, is generally alloyed with other metals. Silver and copper are the principal alloys used, although iron is used in small quantities for different purposes. Pure silver has a brilliant white color and is the whitest of all metals; none surpasses it in lustre, and in hardness it ranges between pure gold and pure copper. It is more fusible than copper or gold, melting at a bright red heat or at 1873° F. It is commonly used for the purpose of alloying gold in its pure state, but if too much be added it makes the gold pale. Pure copper is the only metal that has a reddish appearance. It is both malleable and ductile, hence it is very useful as an alloy for gold.

KARAT

Gold is known by karat. The word "karat" is derived from the seed of the Abyssinian coral tree. These seeds which are small and equal in size and weight are said to be the original karat weights of jewelers. Jewelers and assayers divide the troy pound, ounce or other weight into twenty-four parts and call each a karat as a means of stating the proportion of pure gold contained in any alloy of gold with other metals. Thus pure gold being considered as 24 karat fine, if two, six, or ten twenty-fourths of alloy is present

the gold is said to be 22, 18, or 14 karat fine. This does not apply to the karat used in weighing diamonds and other precious stones, as the karat so used has a fixed weight and is divided into "karat grains" and fractions thereof.

To find the number of karats desired take

500 dwt. Gold
200 dwt. Silver
100 dwt. Copper

800 dwt.

This makes a total of 800 dwts. Now multiply the gold alloy, 500 dwt. x 24 Grains = 12000. Divide 12000 by 800 and it gives 15 Kt. Gold.

Another problem:

300 dwt. Gold
150 dwt. Silver
150 dwt. Copper

600 dwt.

$300 \times 24 = 7200$ divided by 600 = 12 Kt.

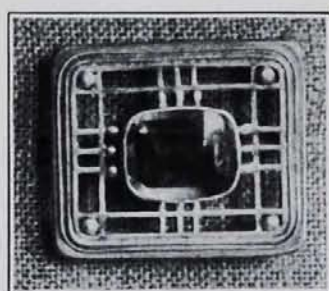




FIGURE 7. Gold Bars

The gold represented in the above illustration is worth \$2,617.24. The largest bar is worth \$629.89 and the smallest one \$318.08. The U. S. Government charges the banks one-twentieth of 1 per cent. plus the express for gold in this form.

GOLD COIN AND BARS

Gold coin is sometimes used in the jewelry industry but more often gold bars are used which are obtained from the United States Treasury by banks and circulated to their customers. The advantage to the manufacturer in using coin gold is that its fineness is fixed being 22 karat. The gold bars vary in fineness, although they are supposed to be 24 karat; they also vary in size from one worth \$200 to one worth \$700. A bar $2\frac{1}{8}$ " x $1\frac{7}{16}$ " x $1\frac{3}{16}$ " is worth about \$546.40.

It is estimated that if all the gold in the world were brought together it would make a cube of sixty feet on a side and would be worth approximately \$82,168,374,240.



FIGURE 8. California miners panning gold

PAN GOLD

Gold was probably originally obtained by washing it from sand and gravel and melting it in an open furnace by the use of the blow pipe. The invention of hand bellows marked a great advancement in the art. Gold in California was first found in nuggets or grains by digging the sand and gravel along the streams or rivers and washing it in a pan, which was originally the cooking pan of the prospector. Gold obtained in this way was called pan gold and although a slow process it yielded very well. Later a sluice was made of wood slightly inclined through which the sand and



FIGURE 9. Shaft mining. Early method of raising quartz to the surface

gravel was carried by a stream of water and as the gold was heavier than the waste material it settled to the bottom of the sluice and was later recovered. Hydraulic mining is done where there is a large supply of water and where the water under high pressure is directed toward a hillside or bank of earth or sand by the use of a large hose. This water carries with it earth, sand and gold through sluices to the mill where it is recovered.

GOLD MINING

Gold is also mined from long veins which run through rock or quartz far below the surface. Shafts have to be driven many hundreds of feet below the surface, with chambers extending in many directions. The rock is drilled and blasted and drawn to the sur-

face in large buckets or elevators. It is then taken to the stamp mill or crusher where it is reduced to a powder and spread over tables slightly inclined. A stream of water is allowed to pass over these tables which carries off everything but the gold which settles to the bottom.

SMELTING AND REFINING

After the gold has been recovered in the various ways mentioned, it is taken to the smelter or refining mill where all other metals, such as silver and copper which are usually found with gold, are separated leaving only pure gold. It is then melted and poured into ingots and shipped to one of the United States Assay Offices where it is assayed and made into bars of various sizes. These bars are then sent about the country to various banks having a call for gold in this form. It is from these banks that the manufacturing jeweler gets the bars of gold and he alloys it to suit the grade of work he manufactures.



GOLD ALLOYS

Gold above 18 karat is used only for special work. Eighteen karat or 14 K. are best for most jewelry as they are harder and their wearing qualities better. Various colors of gold may be produced by the use of different alloys as follows:

Yellow Gold	—pure or fine gold.
Brown Gold	—fine gold 5 parts, copper 1 part.
Red Gold	—fine gold 3 parts, copper 1 part.
Gray Gold	—fine gold 16 parts, iron 1 part.
Green Gold	—fine gold 3 parts, silver 1 part.
Pink Gold	—fine gold 5 parts, silver 4 parts, copper 1 part.
Blue Gold	—fine gold 3 parts, iron 1 part.
White Gold	—fine gold 2 parts, silver 1 part.

GOLD SOLDERS

Easy flowing solder for 10 K. work.

10 K. Gold	4 parts.
Coin Silver	1 part.
Cadmium	1 part.

Drop Cadmium in just before pouring.

14 K. Solder

14 K. Gold	4 parts.
Coin Silver	1 part.
Cadmium	1 part.

12 K. Solder

Fine Gold	12 parts.
Fine Silver	7 parts.
Fine Copper Wire	5 parts.
Zinc	8 grs.

Zinc to be added just before pouring.

Silver Solder.

*Silver - 2 parts }
Brass - 1 part }
2 parts of copper.
1 part of zinc.*

REDUCING TABLE

To Alloy Gold from any Karat to any lower Karat.

From	To 8K. Dwts.	To 10K. Dwts.	To 12K. Dwts.	To 14K. Dwts.	To 16K. Dwts.	To 18K. Dwts.	To 20K. Dwts.	To 22K. Dwts.
24K. —	2.000	1.400	1.000	.714	.500	.333	.200	.091
23K. —	1.875	1.300	.917	.643	.438	.278	.150	.045
22K. —	1.750	1.200	.833	.571	.375	.222	.100	
*21.6K.—	1.700	1.160	.800	.543	.350	.200	.080	
21K. —	1.625	1.100	.750	.500	.313	.167	.050	
20K. —	1.500	1.000	.667	.429	.250	.111		
19K. —	1.375	.900	.583	.357	.188	.056		
18K. —	1.250	.800	.500	.286	.125			
17K. —	1.125	.700	.417	.214	.063			
16K. —	1.000	.600	.333	.143				
15K. —	.875	.500	.250	.071				
14K. —	.750	.400	.167					
13K. —	.625	.300	.083					
12K. —	.500	.200						
11K. —	.375	.100						
10K. —	.250							
9K. —	.125							

EXPLANATION OF TABLE

To alloy from any karat to any lower karat locate karat of metal on hand in left hand column of table; then read across until you reach the column headed by the karat you wish to secure. That figure will represent the number and fraction of dwts. of alloy that you must add to each dwt. of the original gold.

GENERAL FORMULA FOR REDUCING THE FINENESS OF GOLD

Multiply the weight by the difference between the fineness on hand and the fineness required, and divide by the latter. The result will be the weight of alloy to be added.

EXAMPLE

Reduce 100 dwt. of 14 K. stock to 10 K.

The difference between the finenesses is 4. By the rule we have

$$\frac{100 \times 4}{10} = 40 \text{ dwt. of alloy to be added.}$$

*American Gold Coin.

GOLD COINS

REDUCING TABLE FOR U. S. MONEY

To reduce a U. S. gold piece to any of the karats given, add alloy to the amount indicated opposite the denomination of the gold piece and under the karat wanted.

	To 8K. Dwts.	To 10K. Dwts.	To 12K. Dwts.	To 14K. Dwts.	To 16K. Dwts.	To 18K. Dwts.	To 20K. Dwts.
\$20 Gold Piece	36.550	24.940	17.200	11.675	7.525	4.300	1.720
\$10 Gold Piece	18.275	12.470	8.600	5.838	3.7638	2.150	.860
\$ 5 Gold Piece	9.138	6.235	4.300	2.919	1.881	1.075	.430

A \$20 Gold Piece weighs 516 Grains, or 21.50 dwts.

A \$10 Gold Piece weighs 258 Grains, or 10.75 dwts.

A \$ 5 Gold Piece weighs 129 Grains, or 5.375 dwts.

U. S. and Canadian gold coins are .900 fine, or 21.60 karats.

RAISING TABLE FOR U. S. MONEY

To raise a \$20 Gold Piece to 22K. add 4.300 dwts. fine gold.

To raise a \$10 Gold Piece to 22K. add 2.150 dwts. fine gold.

To raise a \$ 5 Gold Piece to 22K. add 1.075 dwts. fine gold.

Gold coins of Great Britain are .916 2-3 fine, or 22 karats.

FINENESS OF GOLD KARATS

1K. .0417	13K. .5417
2K. .0833	14K. .5833
3K. .1250	15K. .6250
4K. .1667	16K. .6667
5K. .2083	17K. .7083
6K. .2500	18K. .7500
7K. .2917	19K. .7917
8K. .3333	20K. .8333
9K. .3750	21K. .8750
10K. .4167	22K. .9167
11K. .4583	23K. .9583
12K. .5000	24K. 1.0000

UNIT WIRE TABLE

WEIGHT OF ROUND WIRE IN DWTS.

Square wire is 1.27324 times as heavy as round wire of the same gauge.

	DWTS.
1 foot of round Platinum Wire	.001" in diameter, weighs .002138
1 foot of round 24K. Gold Wire	.001" in diameter, weighs .001923
1 foot of round 18K. Green Gold Wire	.001" in diameter, weighs .001577
1 foot of round 18K. Yellow Gold Wire	.001" in diameter, weighs .001507
1 foot of round 18K. Red Gold Wire	.001" in diameter, weighs .001481
1 foot of round 14K. Green Gold Wire	.001" in diameter, weighs .001407
1 foot of round 14K. Yellow Gold Wire	.001" in diameter, weighs .001317
1 foot of round 14K. Red Gold Wire	.001" in diameter, weighs .001284
1 foot of round 10K. Yellow Gold Wire	.001" in diameter, weighs .001170
1 foot of round 10K. Red Gold Wire	.001" in diameter, weighs .001134
1 foot of round Fine Silver Wire	.001" in diameter, weighs .001049
1 foot of round Sterling Silver Wire	.001" in diameter, weighs .001034
1 foot of round Copper Wire	.001" in diameter, weighs .000877

HOW TO USE THE WIRE TABLES

Take the number of thousandths in the diameter of the wire whose weight you wish to determine, square that figure (multiply it by itself), and multiply the product by the weight of 1 ft. of wire of the corresponding metal shown in the above table. The result will be the weight of one foot of the wire. To find the weight of the entire piece multiply the weight of one foot by the number of feet in the piece.

Example: To find weight of 50 ft. of round platinum wire .020 diameter.

$$20 \times 20 = 400$$

Platinum wire weighs .002138 dwts. (see table.)
 $400 \times .002138 = .8552$ dwts., the weight of 1 foot multiplied by 50 = 42.760 dwts., the weight of the piece.

For square wire the process is the same.

UNIT SHEET TABLE

Weight of a Square Inch of Metals shown one thousandth of an inch thick.

	OUNCES TROY	DWTs. TROY
Platinum.....	1" sq. x .001 weighs .0113427 or	.226854
24K. Gold.....	1" sq. x .001 weighs .0101994 or	.203988
18K. Gold, Green.....	1" sq. x .001 weighs .0083660 or	.167320
18K. Gold, Yellow.....	1" sq. x .001 weighs .0079973 or	.159946
18K. Gold, Red.....	1" sq. x .001 weighs .0078550 or	.157100
14K. Gold, Green.....	1" sq. x .001 weighs .0074652 or	.149304
14K. Gold, Yellow.....	1" sq. x .001 weighs .0069857 or	.139714
14K. Gold, Red.....	1" sq. x .001 weighs .0068119 or	.136238
10K. Gold, Yellow.....	1" sq. x .001 weighs .0062060 or	.124120
10K. Gold, Red.....	1" sq. x .001 weighs .0060164 or	.120328
Fine Silver.....	1" sq. x .001 weighs .0055637 or	.111274
Sterling Silver.....	1" sq. x .001 weighs .0054843 or	.109686
Fine Copper.....	1" sq. x .001 weighs .0046519 or	.093038
Brass, wrought.....	1" sq. x .001 weighs .0044254 or	.088508

To find the weight of a piece of any of the above metals of any given size and thickness, multiply the weight of one square inch of the metal .001 inches thick, as shown above, by the decimal thickness desired, and then multiply this product by the number of square inches in the given piece. The result will be the troy weight of the piece. For example: Required the weight of a piece of 14K. yellow gold 3" x 4" gauge .020. From the table, one square inch of 14K. yellow gold .001 or one thousandth of an inch thick weighs .139714 dwt., therefore 1 square inch .020 or 20 thousandths would weigh twenty times .139714, or 2.79428 dwt., and since there are 3 x 4 or 12 square inches in the piece, the total weight would be 12 x 2.79428 dwt., or 33.53 dwt.

SILVER

Silver is widely diffused but is rarely found in the native state.

Silver is originally as widespread as gold, occurring in nearly all of the volcanic rocks. Whereas gold remains unaltered by the action of the elements and is often carried long distances from its original place of occurrence, silver on the contrary is only to be found in the rocks where it originally occurs. When these rocks are broken down or worn away, the silver is either driven into new mineral combinations, or more often dissipated and lost. Silver, therefore, is only to be obtained by subterranean mining. Shafts are driven and the ore brought to the surface, and by use of various processes the silver is extracted, refined and made ready for commercial purposes.

An old process and one still employed extensively throughout Mexico where a large quantity of silver is produced, is to take the ore after it has been crushed or reduced to a fine mud or puddle and spread it about two feet deep over the floor of a large courtyard. Powdered sulphate of copper is spread over the mass and then horses or mules are driven around in circles to tread the sulphate in and mix it thoroughly with the ore. After about one day's treading a quantity of common salt is added and after two days more treading quicksilver is added. This mass is trodden over for a period of about fifteen days, and is then shoveled into a large tank through which a rapid stream of water is passed. This washes away all but the silver and quicksilver, which is then poured into cone-shaped canvas bags. Most of the quicksilver runs out leaving the silver which is then retorted. The quicksilver is used over and over again to assist in recovering the silver.

Pure silver has a beautiful white color and lustre; it is almost as plastic as pure gold and like it very soft.

Silver does not tarnish in natural air, but when it comes in contact with sulphur compounds it readily forms black silver sulphide. The sulphur compounds which act on silver are found in small quantities in the air as a result of burning coal and illuminating gas, while larger amounts occur in vulcanized rubber, wool, and foods like eggs.

Pure silver is too soft to make durable objects that require lightness and stability of form. This defect is overcome by alloying it with a little copper.

An alloy of 925 parts fine silver and 75 parts copper is called 925-1000 fine or what is commonly known as sterling silver. This alloy is used almost universally for jewelry and the best silverware.

MELTING POINTS AND SPECIFIC GRAVITY OF THE
PRINCIPAL METALS

Metal	Melting Point Fahrenheit	Melting Point Centigrade	Specific Gravity
Platinum*	3191	1755	21.53
Nickel	2420	1450	8.90
Gold	1945	1063	19.36
Copper	1981	1083	8.83
Silver	1762	961	10.56
Zinc	786	419	7.00
Lead	621	327	11.36
Tin	450	232	7.29

*Infusible, except by the oxy-hydrogen blow pipe.

WEIGHTS

THE POUND STERLING

The earliest series of standard weights known were discovered in the ruins of Nineveh and are now in the British Museum. The old Saxon pound was the earliest standard of England. The pound sterling was determined from this weight in silver. In 1266 Henry II decreed the following standards: The sterling, or penny to weigh equal to thirty-two wheat corns, taken from the middle of the ear; twenty pence, one ounce; twelve ounces, one pound; eight pounds, one gallon of wine, which is the eighth part of a quarter. The idea of the grain was borrowed by the English from the French, and the Black Prince brought back with him from France the pound Troye, which was derived from the commercial town of that name. The use of the Troy standard was adopted by the druggists and jewelers, on account of its convenient reduction into grains. The pound avoirdupois, weighing 7,000 grains Troy (Fr. Avoir-du-poids, "to have weight"), first appears in use during the reign of Edward III and it as well as the Troy pound has been employed without change ever since.

The unit of weight in the United States is a Troy pound weight obtained from England, a duplicate of the original standard. It is a bronze weight of 5,760 grains Troy and is kept in a strong safe at the United States Mint in Philadelphia. On the second Wednesday in February each year, the safe is opened when the copies or the working weights are compared with the original upon the most delicately poised balances. Working standards are supplied by the Secretary of State to the state governments, which in turn supply them to the sealers of weights and measures of the various countries who must compare with the state standard once a year.

TROY WEIGHT

Used in weighing the Precious Metals, Gold, Silver
and Platinum

24 grains	=	1 pennyweight
20 pennyweight	=	1 ounce
12 ounces	=	1 pound (lb.)
or 5,760 grains.		

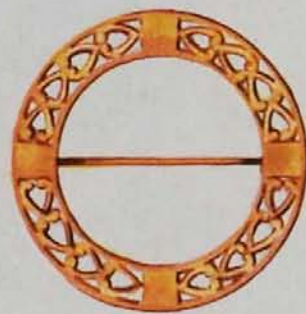
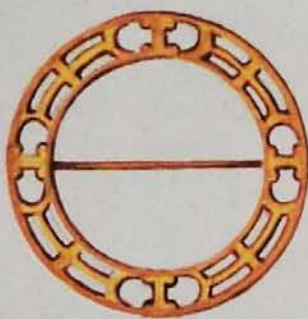
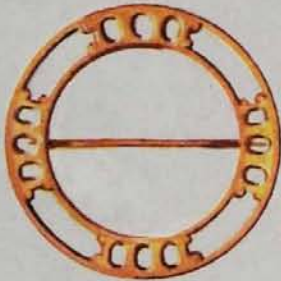
AVOIRDUPOIS WEIGHT

16 drachms	=	1 ounce
16 ounces	=	1 pound of 7,000 grains
28 pounds	=	1 quarter
4 quarters	=	1 hundred-weight (cwt.)
20 cwts.	=	1 ton.

DIAMOND WEIGHT

In weighing precious stones the Karat is the unit of weight which is equal to $3 \frac{1}{16}$ grains Troy. For convenience the Karat is divided into 100 parts.

1 K	=	100
$\frac{1}{2}$ K	=	50-100
$\frac{1}{4}$ K	=	25-100
$\frac{1}{8}$ K	=	$12\frac{1}{2}$ -100



Chapter IV

Processes Involved in Jewelry Making

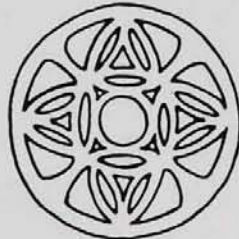
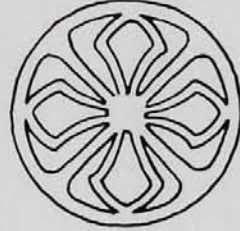
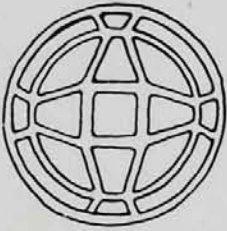
THERE are different ways of approaching the subject of jewelry making. Some begin by having the student or beginner take for the first problem one that calls for the use of wire bending and soldering. Others give a problem calling for the introduction of a variety of processes in one piece. It has been the author's experience, however, that the best and most satisfactory results are obtained both from the student's point of view and the consideration of the finished product when the student is led to advance from the simple problem to the more complex by a series of elementary problems carefully graded. The beginner has not only to learn the processes involved in the making of a piece of jewelry but also to master the various tools used and to learn the limitations of his material. Although the number of tools used in jewelry making are few comparatively speaking, it seems best for the beginner to take them up one or two at a time and plan his problem accordingly.

The processes involved in jewelry making are as follows:

Sawing	Stone Setting
Filing	Polishing
Bending	Modeling
Carving	Casting
Embossing or repoussé	Hub and Die Cutting
Soldering	Stamping or Pressing

Each of these will be taken up and explained in the various problems that follow.

PIERCED BROOCHES

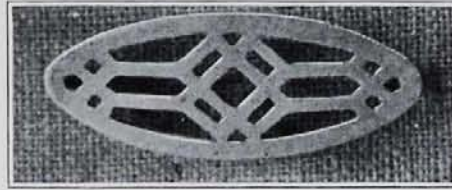


Chapter V

Brooches Pierced without Stones



A



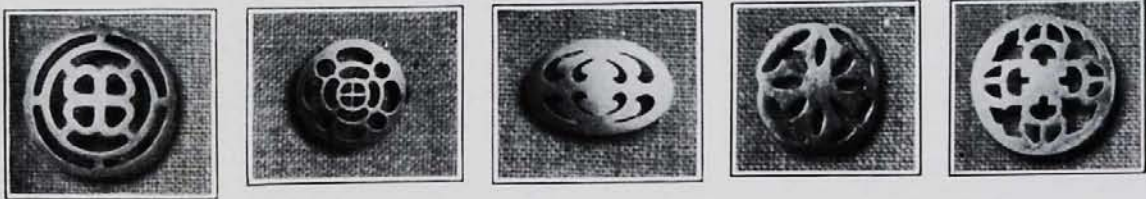
B

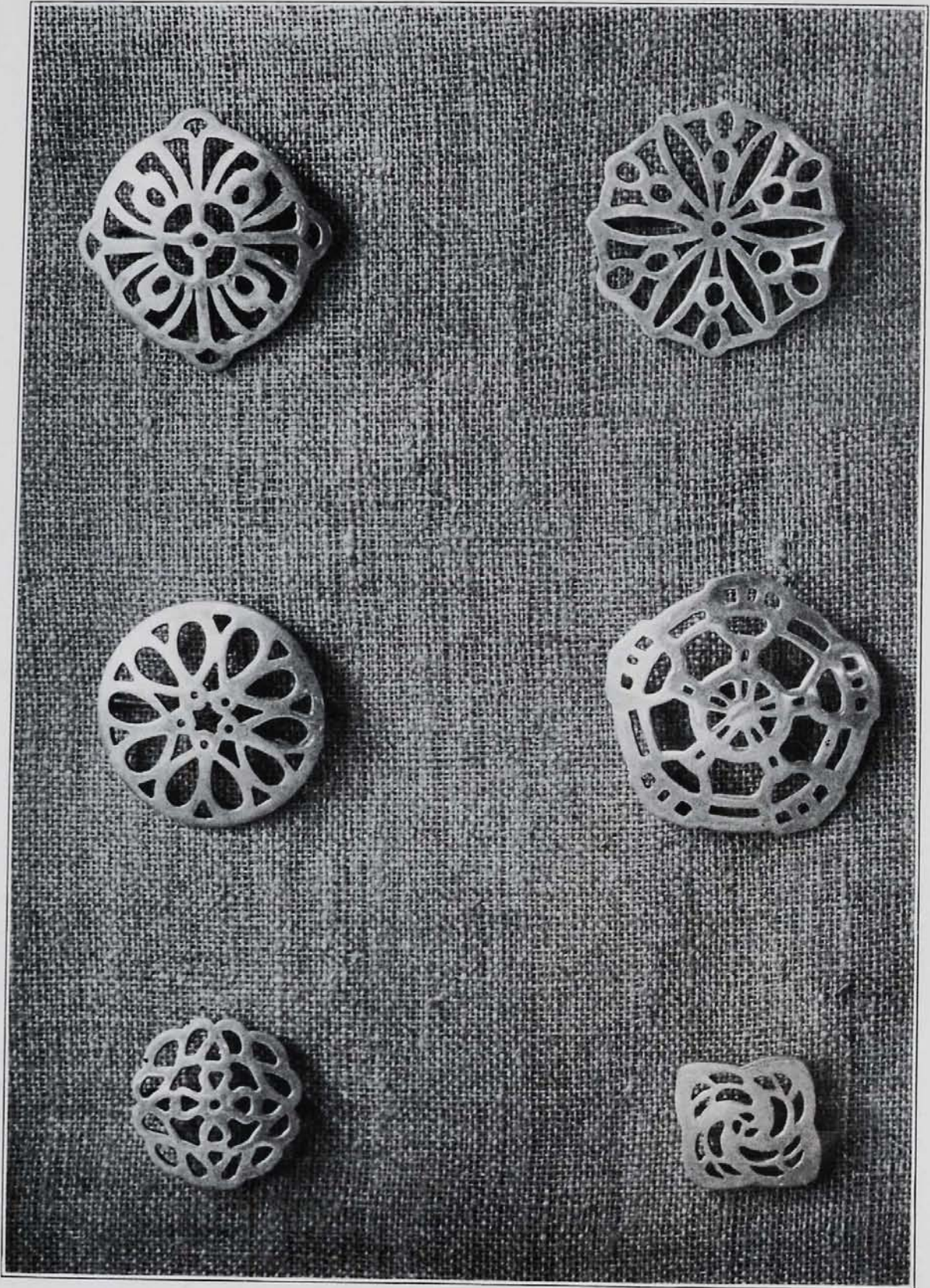


C

PROBLEM I, FIGURE 10

PROBLEM I. For the first problem we will describe the making of a brooch or breast pin, Fig. 10-A, one that requires only the use of the saw and files, confining the process to piercing. For the first one we will select a design that does not have too many details. A good design may be ruined if poorly executed, and, on the other hand, a poor design is not improved by good workmanship. The design is then of first importance. Plate IX gives a variety of suggestions and Plate X shows several that have been executed. The student of course will not copy any of the illustrations given, as the greatest benefit comes only when the idea is thought out from the beginning to the end. After several sketches have been made to choose from, and the one to be carried out has been decided upon, a drawing is made in pencil outline and then a tracing carefully made from the drawing. It is







A class in Jewelry Making, Rhode Island School of Design

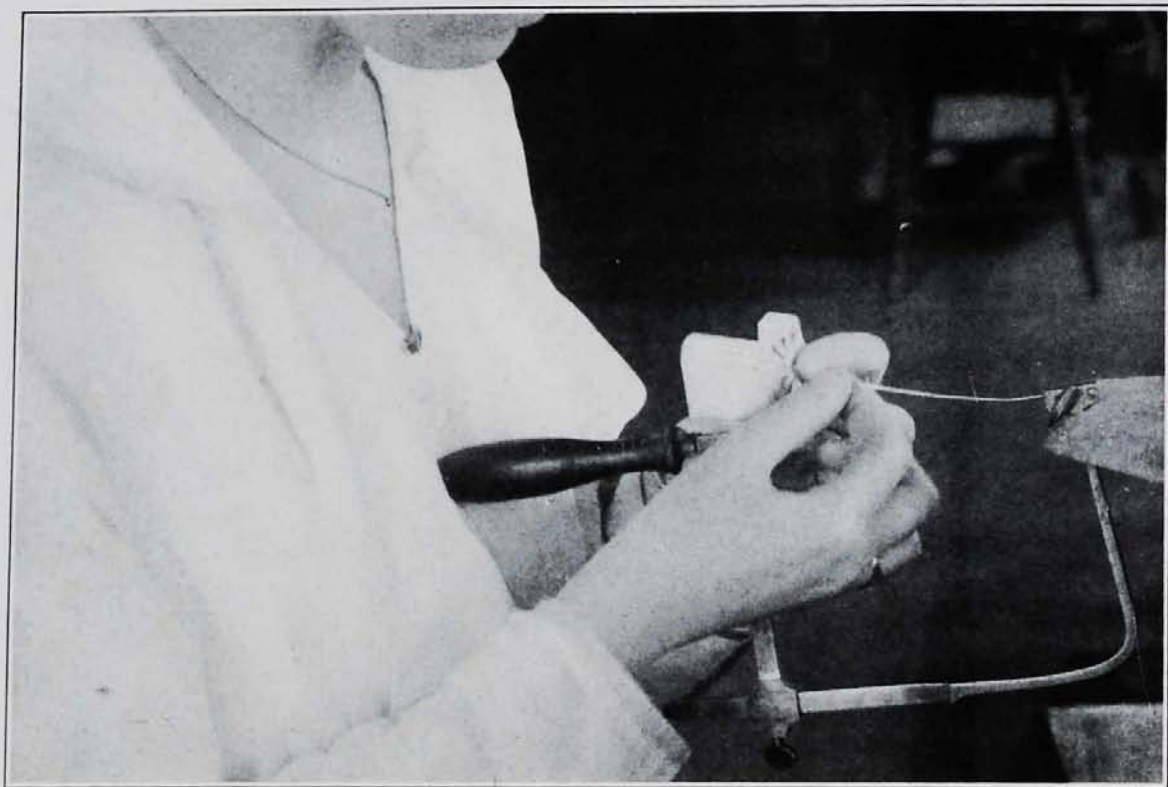


FIGURE 11

of the utmost importance that this tracing be accurately made, as the least deviation from the original drawing will only tend to change the original form and design as the problem is carried out. After the tracing is made we next take a piece of twenty gauge silver a little larger than the design calls for. A drop of liquid glue is placed on the metal and, after diluting it by adding two or three drops of water, it is spread over the surface of the metal and made quite thin. The thinner the glue the greater the adhesion. The tracing is then placed on the silver and allowed to dry. Paste is not satisfactory. The tracing should not be pulled either one way or the other as it tends to stretch and distort the design.

After the tracing is dry a center punch is used to make small depressions in each of the openings to be pierced as a start for the drill. A drill of the right size for the opening is then selected and placed in the chuck and the holes made to admit the saw. The

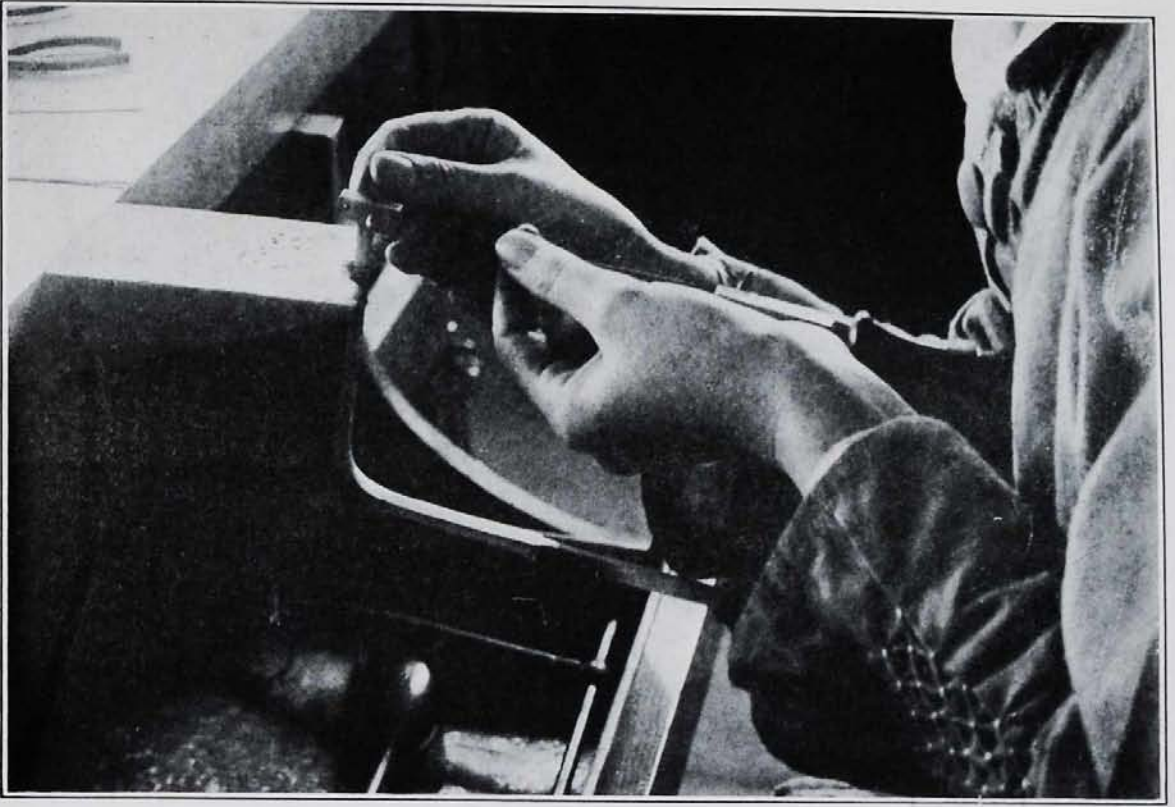


FIGURE 12

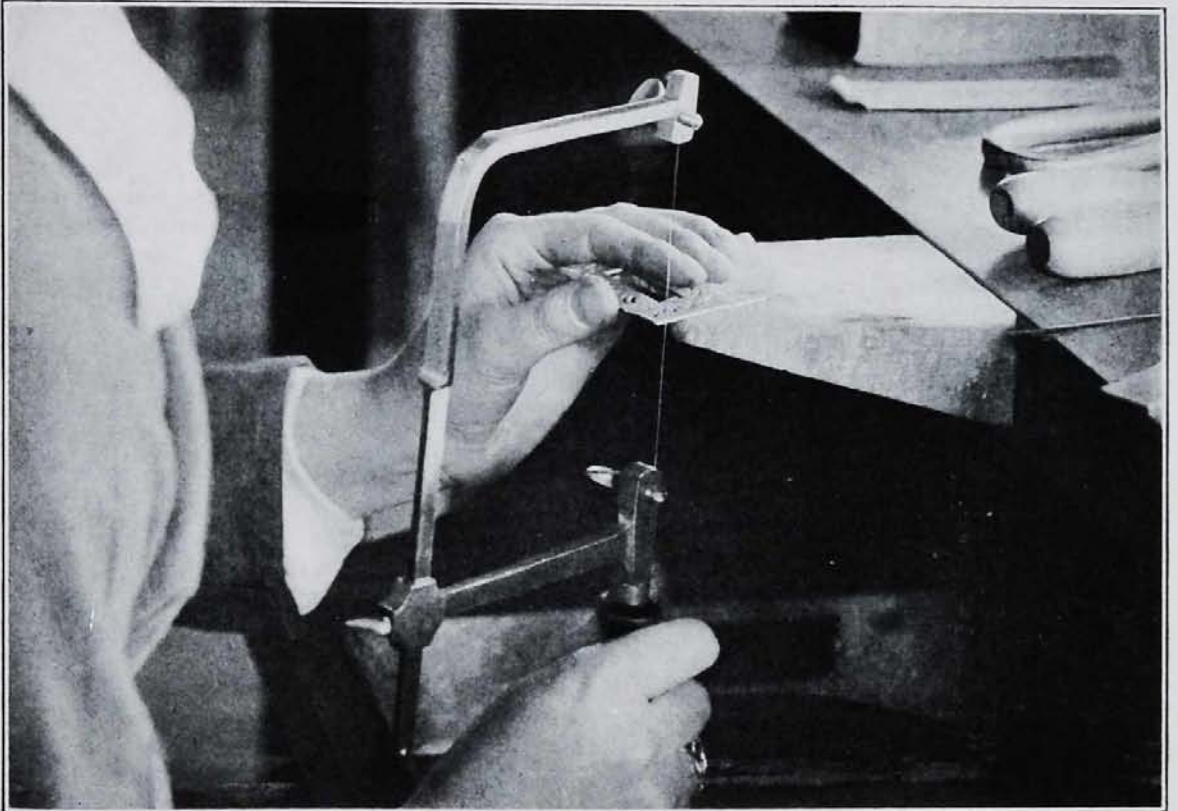


FIGURE 13

BROOCHES





FIGURE 14

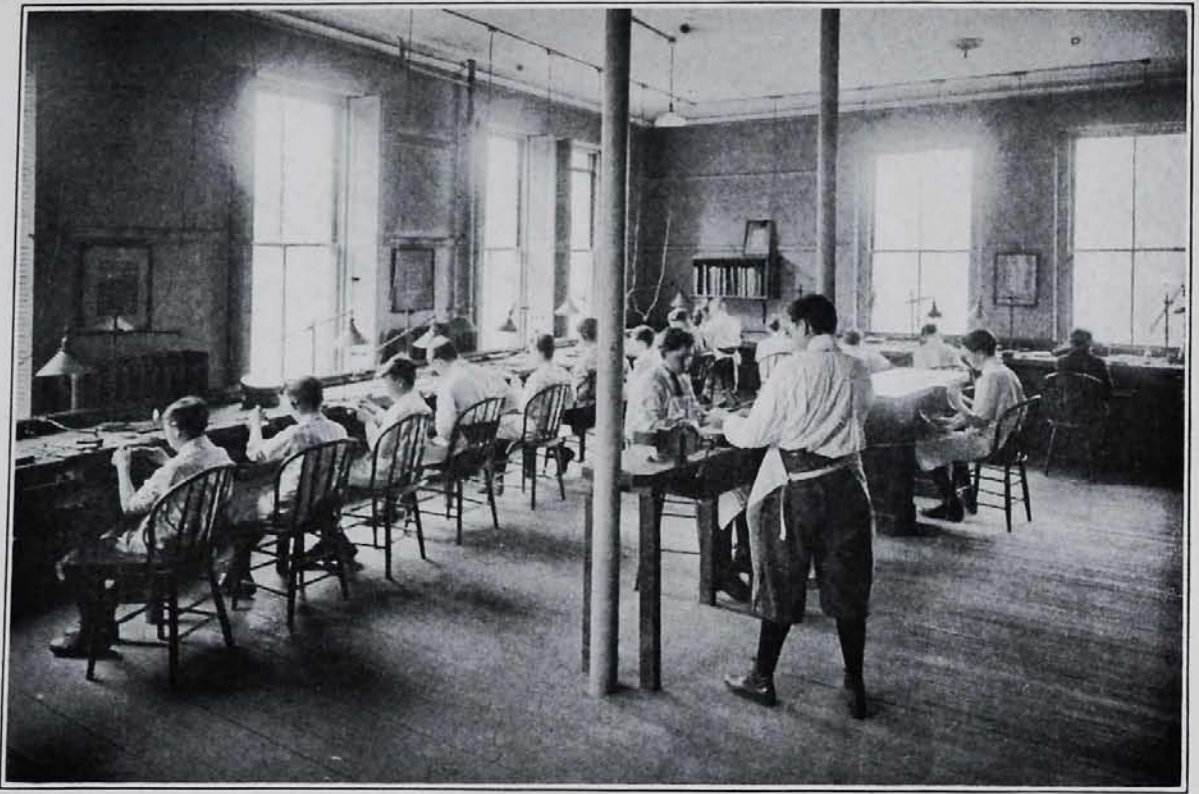


FIGURE 15

saw frame is held as shown in Fig. 11 and a No. 0 saw is fastened in the end of the frame nearest the handle so that the teeth of the saw are on the upper edge and point toward the handle of the frame. The saw is then allowed to pass through one of the holes in the



FIGURE 16



An eighth grade grammar class which comes for work in jewelry one afternoon each week to the Rhode Island School of Design

piece of metal and the other end of the saw is securely fastened. Fig. 12. The tracing should be kept on the top side of the metal. The saw is given an up and down motion cutting on the downward stroke, Figs. 13, 14, 15. A little practice in the use of the saw in this way will enable the beginner soon to do creditable work. After learning to control the saw the lines in the design are followed as closely as possible, being very careful not to cut into the line. After all the interior openings have been sawed out the outline of the brooch is followed in the same way. An assorted set of $3\frac{1}{2}$ in. needle files is now necessary to true up the rough edges left by the saw, Fig. 16. The half round file is the most useful one although there are times when the other shapes will be needed. When all of the details have been carefully trued up with the files, the tracing may be removed by soaking it in water for a minute or two;

and when this has been done the sharp edges of the openings may be removed by holding the file at an angle and going over the edges rather lightly. A strip of very fine emery cloth No. 000 may be used to finish the piercings. A large flat file is used to true up the outline of the brooch if it is regular in outline as Fig. 10-A.



A satisfactory way to keep a collection of stones together

CIRCULAR DESIGNS



Chapter VI
Brooches with Stones



A

B

C

PROBLEM 2, FIGURE 17

PROBLEM 2. We will leave Prob. 1 at this point and take up Prob. 2 which is to be a repetition of Prob. 1 except that it is to have a stone set in the center of the brooch. Fig. 17-B. The piercing is done in the same way as in Prob. 1. When we have carried this to the point where we left Prob. 1 we next take up the making of a setting to hold the stone in place. This setting is called a bezel and is made of a strip of No. 26 gauge metal about one-eighth of an inch wide and long enough to go around the stone. The ends are filed square and, when brought together, are held in place by a piece of No. 30 binding wire, Fig. C, Plate XXIV, Page 110. The next step is to solder the ends together.

THE SOLDERING PROCESS

A borax slate, a piece of borum junk, a small soft hair brush and a piece of silver solder will be necessary to start with. Fig. 19. A little water is placed in the slate and the borum junk is ground around in the water until it becomes milky. The more care exercised in



FIGURE 18

keeping borax and work clean, the more successful the results will be. Now take the bezel for Prob. 2 already made and bound with iron wire and, with the brush, coat the parts to be soldered, being careful to get no more borax about than is necessary. The

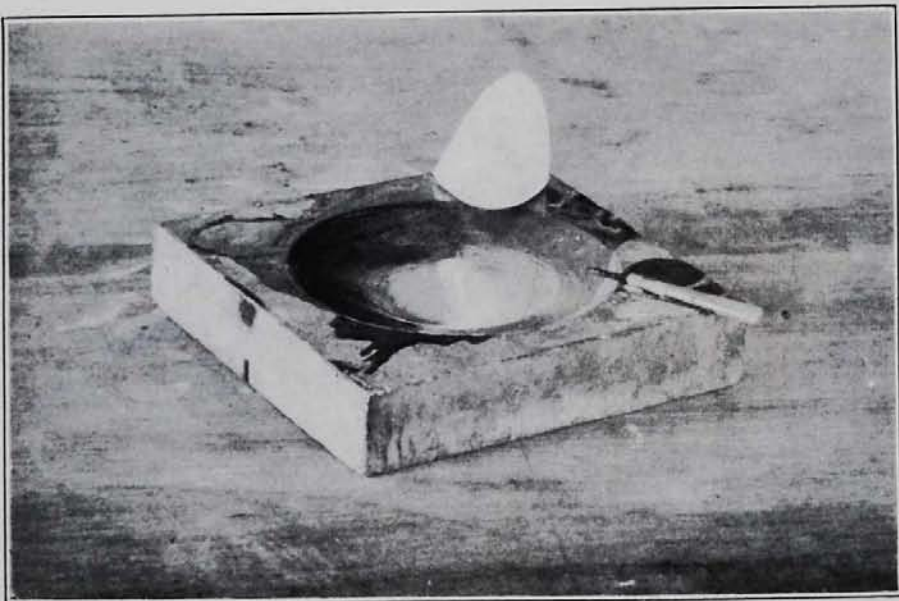
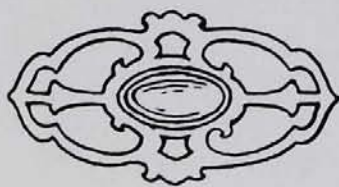


FIGURE 19

PIERCED BROOCHES



solder may be obtained in sheets any thickness, but No. 26 or 28 gauge answers for most purposes. It is cut up in small pieces as shown in Fig. 20.

METHOD OF CUTTING OF SOLDER FOR JEWELRY

It is most important that the student learn to cut solder in the most efficient and economical manner. Experience has shown that the following method is the best.

First, scrape the sheet of solder with a scraper on both sides at the place about to be cut; second, make short parallel cuts evenly distant and about the same length, Fig. 21. Now hold the solder between thumb and second finger with the first in front of cut edge of solder as illustration shows, Fig. 22. Next cut at right angles to set of cuts already made. This releases the solder and it will lay on the finger which keeps it from flying about. This is continued until the required amount of solder is cut.

METHOD OF CUTTING SOLDER

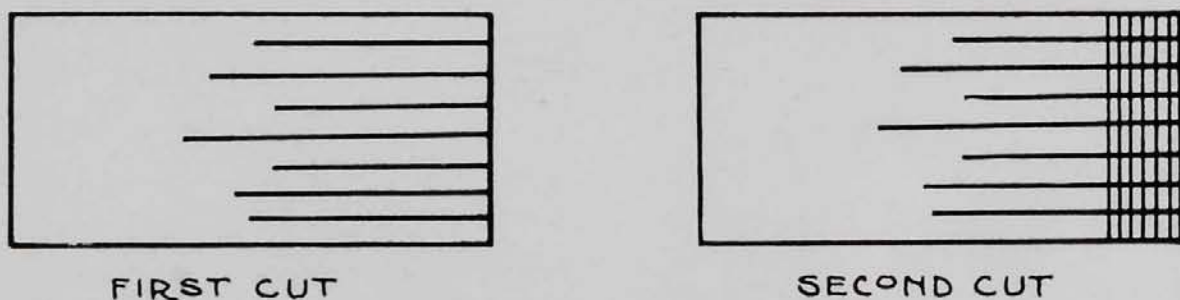


FIGURE 20



FIGURE 21

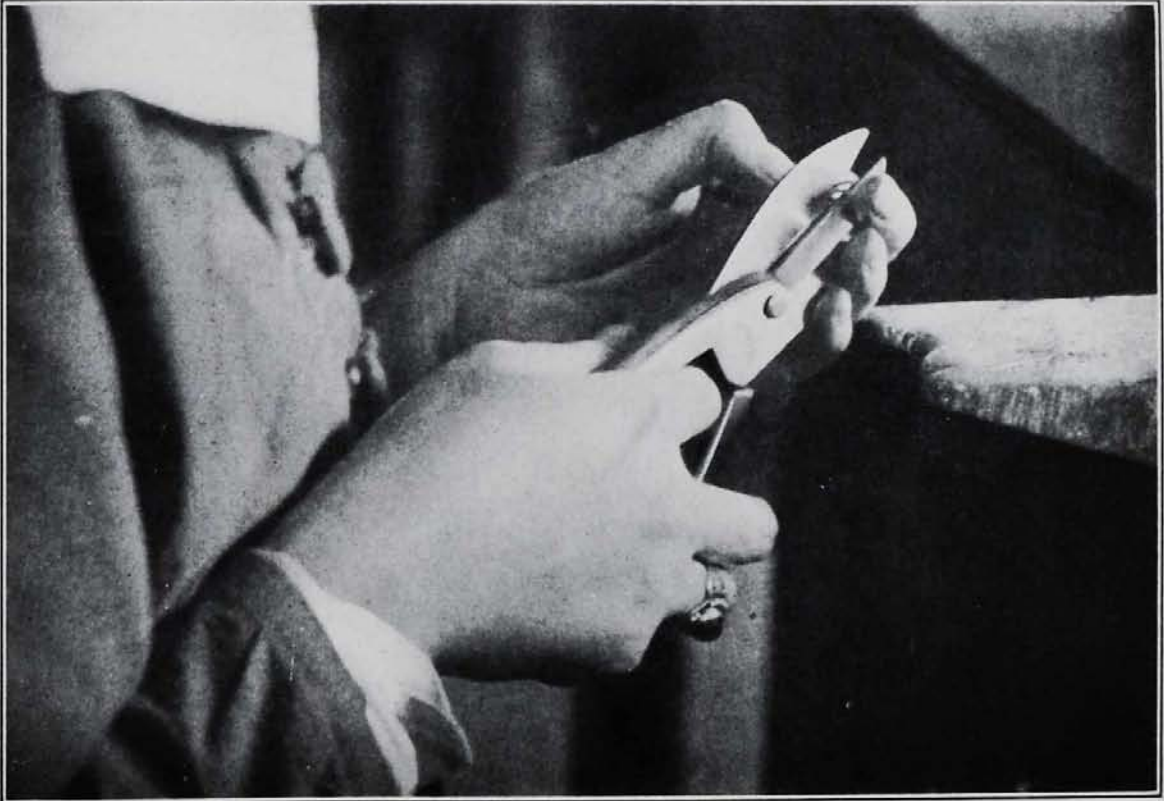


FIGURE 22

BORAX SLATE—BORUM JUNK

After cutting the solder into pieces of the required size, drop them into the borax slate to give them a coating of borax and to remove any grease or foreign substance that may have adhered to them. Place the ring or bezel on a charcoal block, Fig. D, Plate XXIV, and apply to the joint a small piece of solder about one-sixteenth of an inch long and half as wide. A mouth blow-pipe, which may be connected to an ordinary gas cock with rubber tubing, is now needed to supply the heat. After turning the gas on and lighting it is placed in the mouth and blowing at this end dilutes the gas with the air and increases the intensity of the flame. Fig. 18. The size of the flame is regulated by the gas cock. In soldering, the heat should be applied very slowly at first until the water has evaporated and the borax crystallized and dissolved. The flame may then be applied more directly and the bezel brought to the soldering heat. If the heat is applied too quickly it will throw off the solder; and if heated hotter than necessary it is liable to melt or burn the parts being soldered, so the process demands very close attention from the start. After allowing the bezel to cool, remove the wire. If the binding wire should become soldered to the silver, a thing which often happens, it can easily be pulled off with a pair of pliers. Copper or brass wire will not do for binding purposes. The bezel is now pickled or cleaned.

THE PICKLING PROCESS



FIGURE 23. Pickle Pan

The solution called pickle is made of one part of sulphuric acid to fifteen parts of water. This solution may be used cold but is more effective if used hot. When used hot a copper pickle pan is

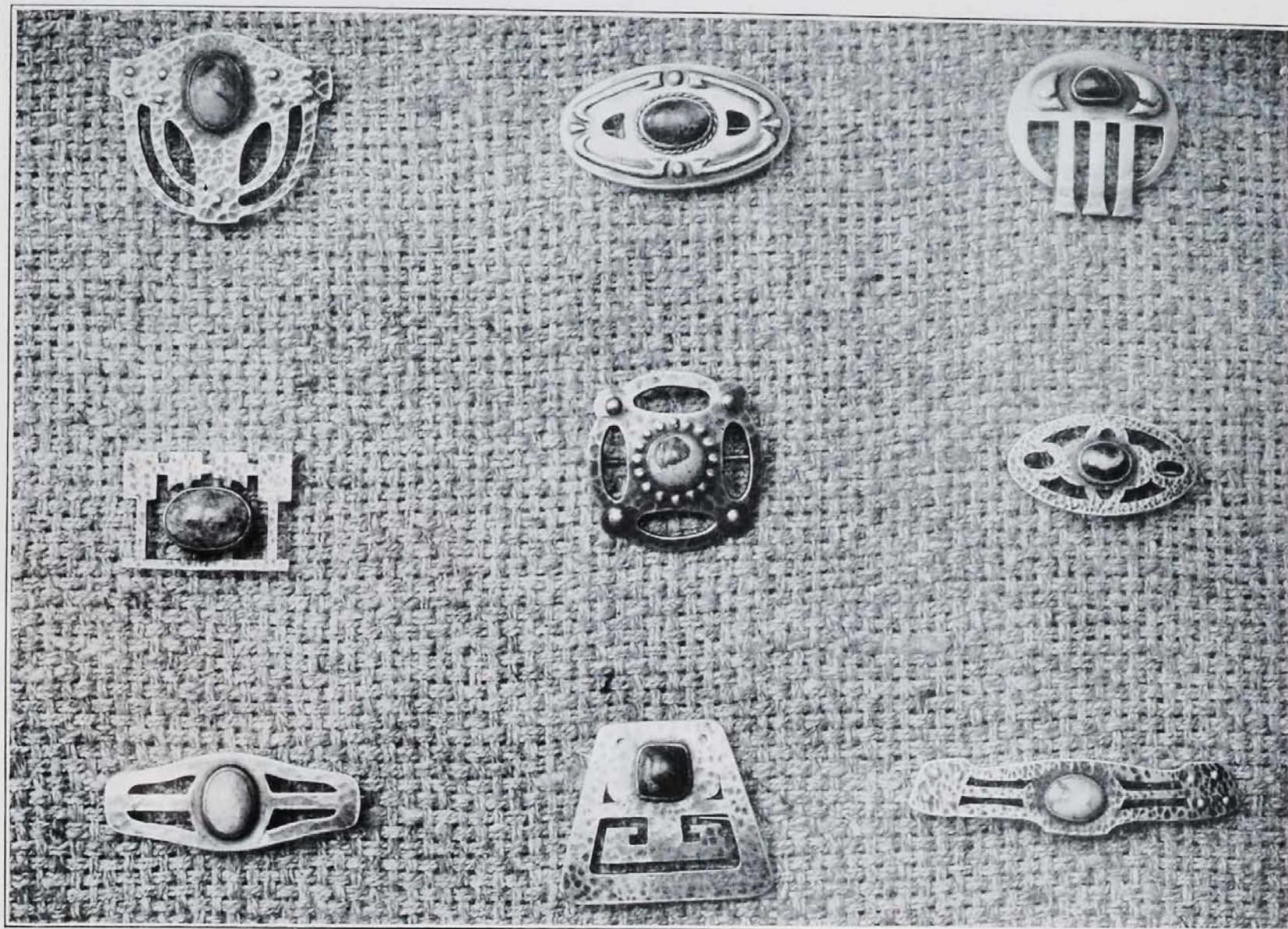
necessary, Fig. 23. The pickle is kept in a pickle pitcher, Fig. 23-A. The object is placed in the pickle pan with enough pickle to cover it, then held over a gas burner and allowed to come to a boiling heat. The pickle is then poured back into the pickle pitcher and the object rinsed in clear water and dried in clean sawdust.



FIGURE 23A

A substitute for the sulphuric acid is now to be had and is called "Pickelrite." It is a chemical in crystal form and when dissolved in water is just as effective as the sulphuric acid and much less expensive. It is not injurious to clothing, etc., neither does it throw off obnoxious fumes as does the acid.

We will now go back to where we left the bezel. After pickling the bezel, the joint is filed inside and out to remove any surplus solder that may have run about the joint. It is then placed over an oval arbor, and tapped lightly with a wooden, horn or rawhide mallet to make it perfectly oval. The wooden, horn or rawhide mallet is used to prevent stretching. It may be that, when the stone is tried in the bezel, it is found that the bezel is a little small; if such is the case, it can be stretched a little by tapping it with a metal hammer while it is on the arbor. The bezel is now filed flat on one side only, using the 6" flat file. This can be done by holding the file in the left hand, resting one end on the bench pin, and holding the bezel between the thumb and fingers of the right hand rub it up and down the file. A burr will form on the edge of the bezel and should be removed either with a small file or a scraper.



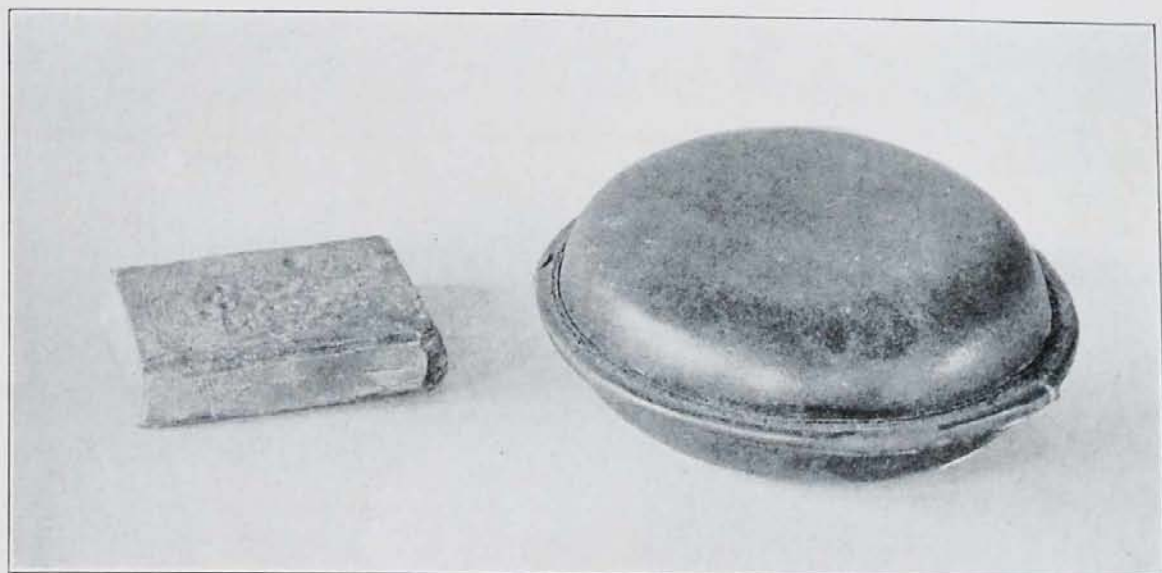


FIGURE 23B

We are now ready to solder the bezel to the brooch; but before soldering to improve the appearance of the brooch when completed it is modeled or domed a little. This can be done either on the end grain of a block of wood or on a sand bag, Fig. 23-B. If the wood is used a small hollow is made with a gouge. The brooch is placed in the depression and brought into shape by striking it with the wooden mallet or a slightly domed punch. Prob. 1 may be domed at this time also.

Now place the bezel on the brooch exactly in the center and mark on the brooch close to the bezel with a scratch awl or some sharp-pointed tool. Next with the scraper scrape on the inside of this line, making a bright surface about 1-16" wide. Borax the edge of the bezel filed flat and the surface of the metal just scraped. Center the bezel and bind with wire as in Fig. K, Plate XXIV, taking care that the bezel is exactly centered. Place small pieces of solder on the inside of the bezel and, with the blow-pipe, apply heat as before; although this time care must be exercised to heat the larger piece first. When the bottom piece has been heated, the flame is directed over the work till the solder outside of the bezel is brought to the fusing point. Again

care must be exercised not to concentrate the flame where the seam of the bezel is; the work should be turned so that the seam is away from the direction in which the flame is applied. After the solder has fused and the joint nicely flushed the flame is quickly removed; and, after it has cooled, the wire is taken off and the piece of work pickled as described before to remove the borax.

We are now ready to apply the joint and catch at the back. Both problems, No. 1 and No. 2, may be prepared and soldered at the same time. The joint and catch may be made by hand or a commercial one may be used. As this part of the problem is not important enough to spend much time on we will use the commercial one. On close examination of these two pieces it will be found that they have slight burrs along the edges that turn over; these must be filed off in order to leave a perfectly flat surface. Scrape the places on the brooch where these are to be soldered. The joint is always placed on the right while the catch is placed on the left with the opening facing down when worn. They should be placed as close to the edge as possible. If the brooch is very much domed the joint must be modified slightly. This is done by bending down on the part upon which the pin-tongue is to rest. The joint and catch are set in place and a piece of solder is placed next to each. It is always advisable when soldering catches and joints to prop work up from charcoal block so that the flame can be directed under the brooch. When soldering these, the flame can be directed under the brooch and the flame should be applied very gradually as they will easily topple over. After the moisture in the borax has evaporated, the flame can be directed under the brooch so that it may become heated first. If the flame were directed on top the small pieces would heat before the larger and the solder would flow upon the catch or joint. For this reason

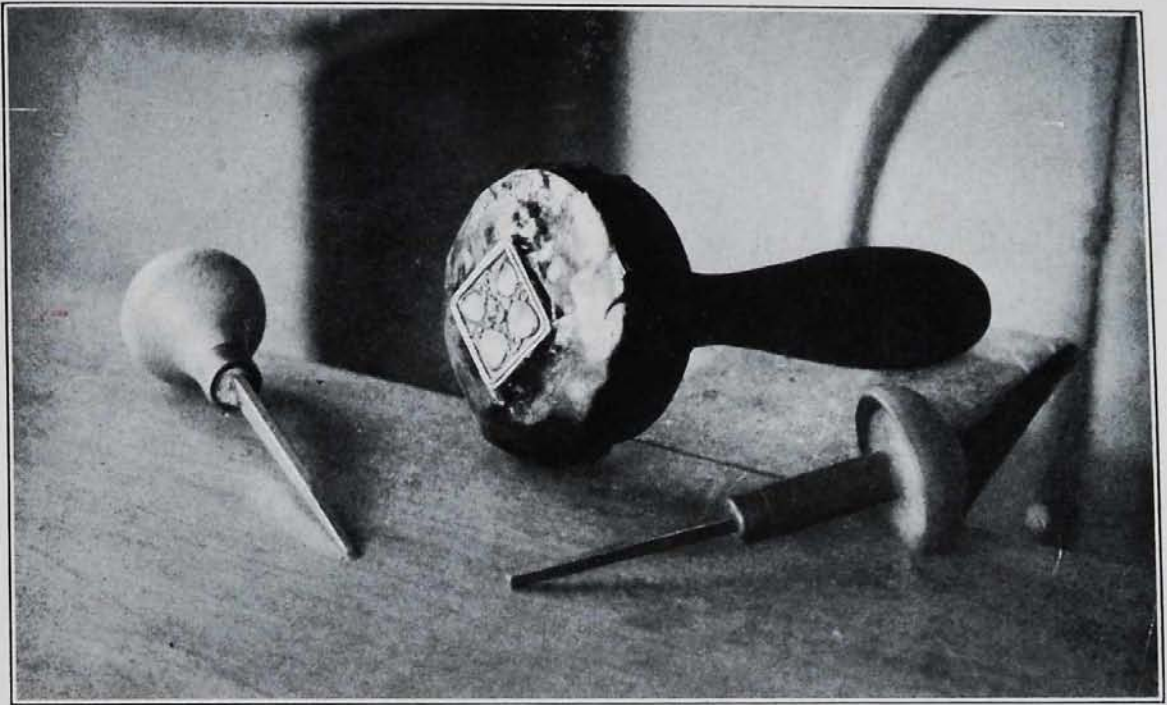


FIGURE 24

both parts should be brought to the soldering point at the same time. The flame should be directed from the side opposite that on which the solder is placed. This will draw the solder toward the flame, hence in under the catch and the joint. This is easily done by directing the flame under the brooch until it is hot, then over it.

When cool the brooch should be thoroughly pickled.

SETTING THE STONE

After the joint and catch have been soldered in place and the brooch has been pickled and cleaned, preparations are made for setting the stone. In the first place we must provide a way to hold the brooch firmly while the stone is being set. To do this take a file handle and a circular block of wood, $2\frac{1}{2}$ inches in diameter and $\frac{3}{4}$ -inch thick and fasten together as shown at Fig. 24. On this place dry orange shellac and melt it with the flame from the blow-pipe, Fig. 25. Repeat this operation until you have about one-quarter



FIGURE 25

of an inch of the shellac on the top of the block. While it is still soft press the brooch into the shellac until the upper part of the brooch has a firm bearing. The shellac is allowed to harden, and this takes but a few minutes. This holds the brooch firmly while the stone is being set.

The bezel is now filed down to the proper height which is determined by the height of the stone, only having enough metal to cover the edge of the stone and to hold it firmly in place. The stone is next put in place and the bezel burnished over the edge. This is done by first taking a small tool, Fig. R, Plate XXV, with a square end called a pusher. With this tool the setting is pushed toward the stone, Fig. 26, first at the four points corresponding to the ends of the diameters as



FIGURE 26



FIGURE 27

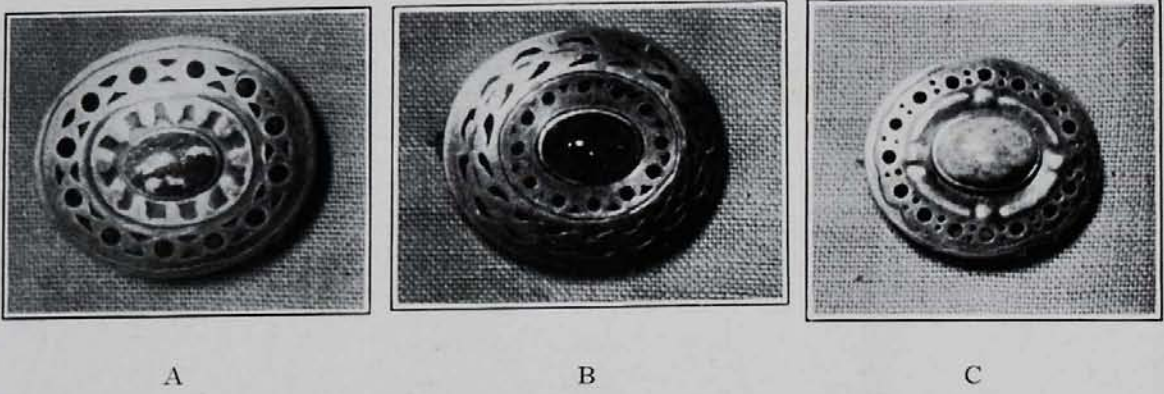


FIGURE 28

at Fig. Q, Plate XXV. This is repeated at the intervening spaces until all parts of the setting touch the stone. A tool, Fig. S, Plate XXV, called a burnisher may be used to rub or burnish the bezel perfectly smooth. A smooth file will finish the sides of the bezel and a No. 40 engraving tool is used to finish the top edge. Fig. 27.

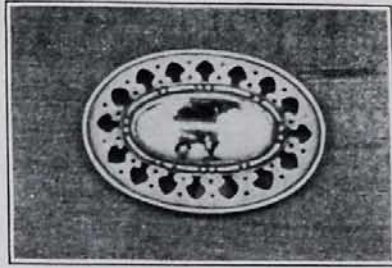
The shellac is now warmed a little with the blow-pipe and the brooch lifted from the block with the tweezers. Care must be taken not to heat the stone, as semi-precious stones will discolor or burn if heated. When the brooch is taken from the shellac block, some of the shellac will adhere to it. This is removed by placing the brooch in a small dish and covering it with alcohol for a few minutes. The polishing and final finishing is next done and then the pin tongue is inserted in the joint. It is often necessary to open the joint a little, and this can easily be done with the chain pliers. After the pin tongue is in place the sides of the joint are pressed together with the pliers. If the pin is too long it can be cut off with the shears and repointed. The point should project a little beyond the catch.

Figure 28-A, B and C show how the drill may be used to produce effective results in the pierced brooch.

Chapter VII
Brooches with Wire Edges



A



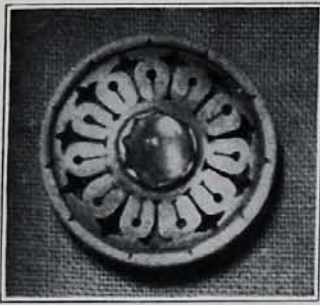
B



C

PROBLEM 3, FIGURE 29

PROBLEM 3. To add to the interest of this problem a wire may be soldered to the edge of the brooch, Fig. 29-A, B and C, when the edge is regular in outline. The wire may be rectangular, round or oval. To get the length needed the wire is placed next to the edge of the brooch and bent around it. It is then cut a little longer than necessary at first and filed to the exact length, butted well together and soldered. The ends can be made to stay in place by springing one by the other a little. This gives a certain amount of spring to it which makes it stay in place while being soldered. Next file surplus solder from the joint. This wire band should fit the brooch very snugly when in place so that no space is left between the wire and edge of the brooch; unless this is the case it should be cut and fitted over again. If wire should be too tight it can be stretched by tapping it lightly with a steel hammer when placed on a round mandrel or arbor. Scrape wire bright on the inside and coat with borax. Now place it around the brooch so that the edge is flush with the back side of the brooch. Place small pieces of solder on the back of the brooch next to the wire at



A



B



C

FIGURE 30

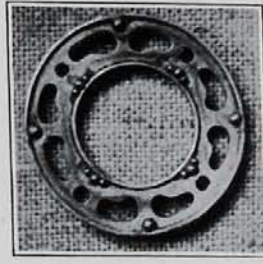
intervals of about one-half inch. The solder is placed on the back in preference to the front so that any superfluous solder that remains can be filed off. When soldering make sure that the solder flows all around. If it does not, apply more borax to solder and try again. The wire should project a very little above the surface of the brooch—about one thirty-second of an inch. If it projects more than this amount, file and make sure that it is uniform in height. If the wire projects beyond the surface on the back it must be filed flush with



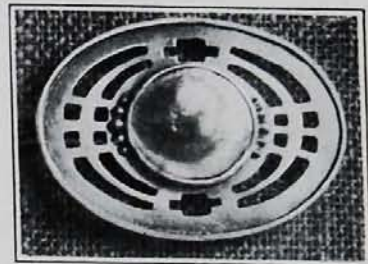
FIGURE 31



A



B



C

PROBLEM 4, FIGURE 32

the back. The wire should be free from sharp edges, and should feel smooth to the touch after it has been filed. Rub with a piece of fine emery cloth. If a round or oval wire is used it may be placed on the face of the brooch instead of on the edge as shown at Fig. 30-A B, and c. It will be noticed in these illustrations that the file has been used to make serrations at intervals along the wire to relieve the plainness of the edge and add interest. When the wire is applied in this way it should be carefully shaped and fitted to the edge of the brooch and held in place during the soldering with wire carried around the brooch as described when soldering the bezel.

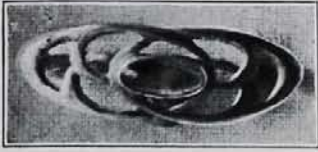
PROBLEM 4. To add still more interest to the brooch, in addition to the wire soldered to the edge described in Prob. 3, we can apply small shot varying in size as shown in Fig. 32-A, B and c. These shot are made by taking round wire (No. 20 gauge) and cutting it up in lengths to give the required size. These small pieces of wire are placed on the charcoal block and, after being coated with borax, are heated to the melting point. This causes them to roll up into the shot. When enough of these have been made they are spaced as desired and soldered in place. A small piece of solder is placed between each two shot. All other soldered joints should be protected with yellow ochre while this soldering is being done. After soldering the shot in place, the brooch is pickled and finished as already described. Fig. B has a rectangular wire soldered about the inside as well as the outside.



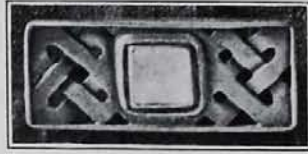
A class of teachers in jewelry

Chapter VIII

Brooches Carved and Ornaments Applied



A



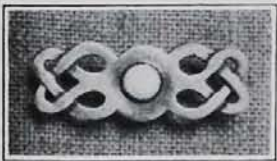
B



C

PROBLEM 5, FIGURE 33

PROBLEM 5. Fig. 33-A, B and C show brooches or pins where the effect of interlacing has been obtained by a little carving. In this problem it is necessary to have the metal a little heavier or thicker than that used in the preceding problems. It should be not less than No. 18 gauge and in cases where considerable relief is desired No. 16 would not be too heavy. After making a tracing from the design, the tracing is glued as before to a piece of silver the required size and thickness. Next take a scratch awl and follow the lines of the design, scratching through the tracing on to the metal, in order to give us the design permanently traced on the metal. This operation must be carefully performed or the character of the design will be lost. The openings and outlines are pierced as previously described and trued up with the files. The interlacing effect is gotten by using the No. 40 graver to cut the metal away at points where one band or line goes under another.



A

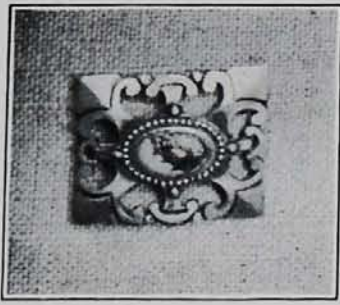


B

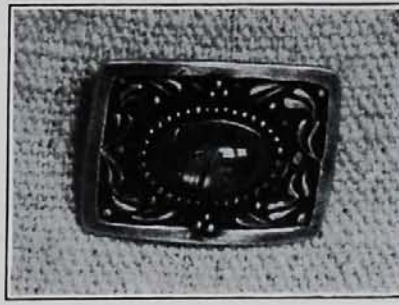


C

FIGURE 34



A



B



C

FIGURE 35

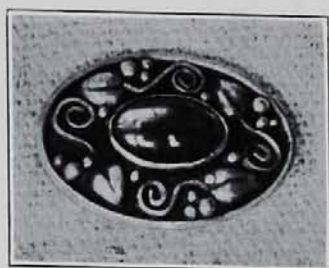
The shellac stick, Fig. 24, is used to hold the piece of metal while it is being carved. After the carving has been done the rough parts are smoothed over with the files. In Fig. A the whole design was filed or carried out in such a way as to give a modeled or rounded effect. The veins in the leaves, Fig. C, were made with a three-cornered file. The flat wire was soldered around the outside of Fig. B after the carving had been done. As a rule it is better to solder the bezel in place after the carving has been done.

In Fig. 35-A, B and C the carving is a little more difficult and requires two or three additional gravers, a No. 38 flat for getting into small spaces and No. 11 round for the curved parts of the design. In Figs. B and C the background is cut away leaving the ornament in relief. It will be noticed that these brooches are domed, a thing which should be done before the bezel is soldered in place.





A



B



C

PROBLEM 6, FIGURE 36

PROBLEM 6. In Prob. 6 the decoration is applied to the surface. Fig. 36-A, B and C show brooches where spirals of wire combined with shot have been used very effectively. A piece of No. 22 gauge metal is used for the back. With the compasses describe a circle the required size then saw and file to the line. Fig. C has a twisted wire about the edge. This is made by taking a piece of No. 24 gauge wire long enough so that when it is doubled it will give the length required to go around the brooch. After doubling the wire place the cut ends in the vise and, with a nail or anything that will serve the purpose, twist the wire as shown at Fig. 14, Plate XXXV. After twisting it from one end to the other remove it from the vise, coat it with borax and place it on the charcoal block, Fig. 15. Put three or four small pieces of solder at equal distances along the wire and heat to the soldering point allowing the solder to run along the wire. This is done to hold the strands together so that they will not separate when cut. Although only two strands of wire were used in Fig C, any number can be used, the twisting being done in the same way. After the wire has been twisted and soldered, it is bent around an arbor to give it the circular form and cut the right size. The ends are soldered together as described in Prob. 3 and, after truing it up on the arbor, it is placed on the

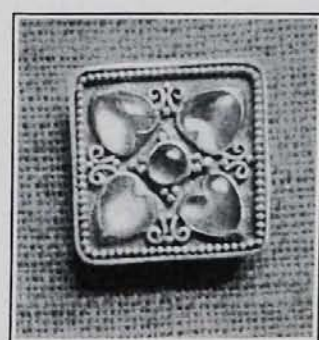


FIGURE 37

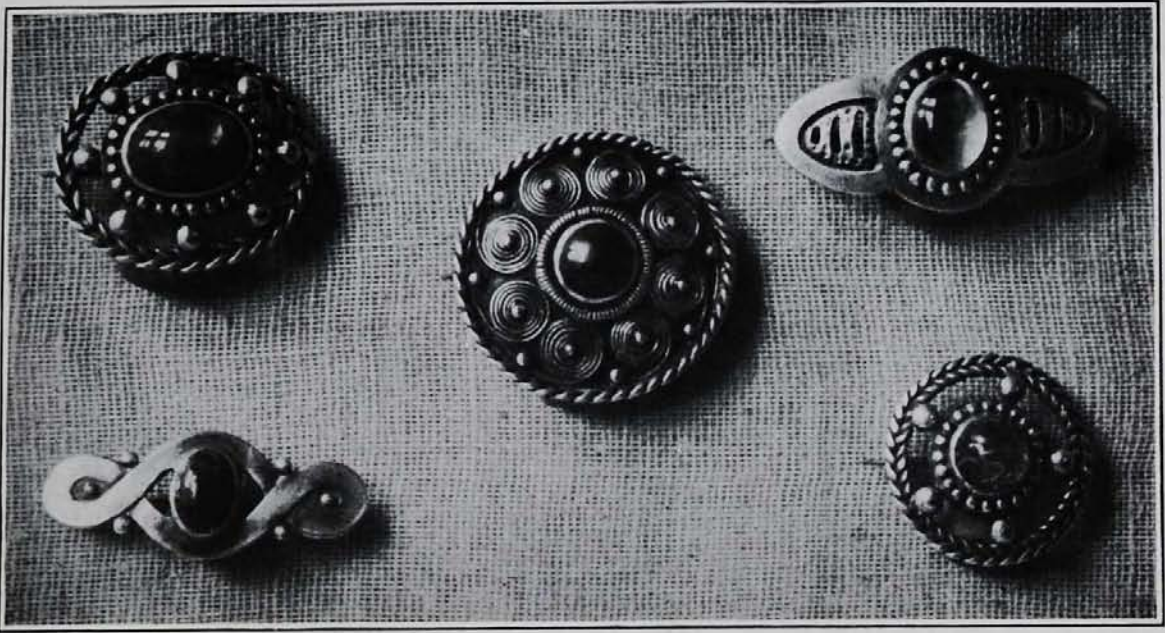
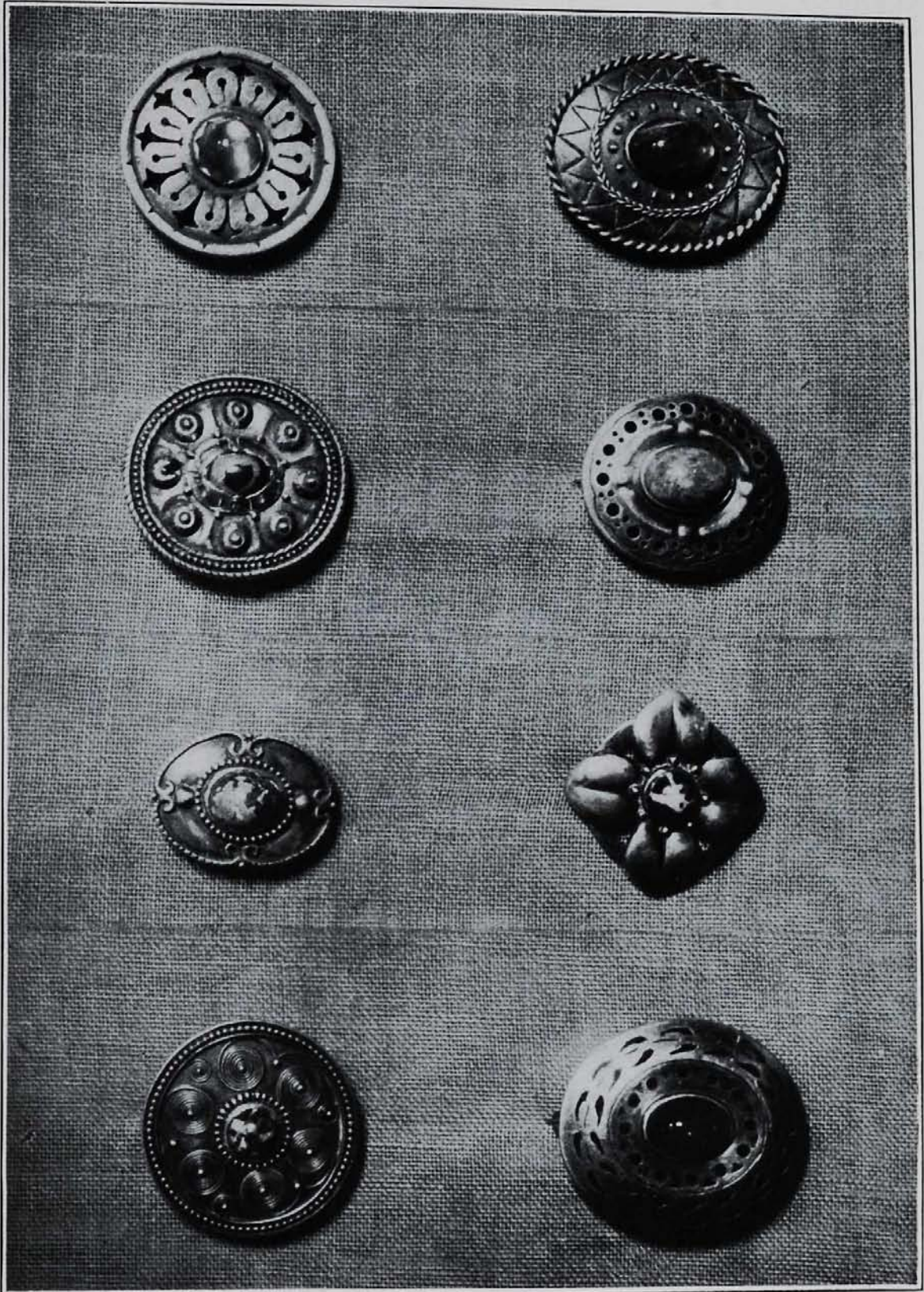


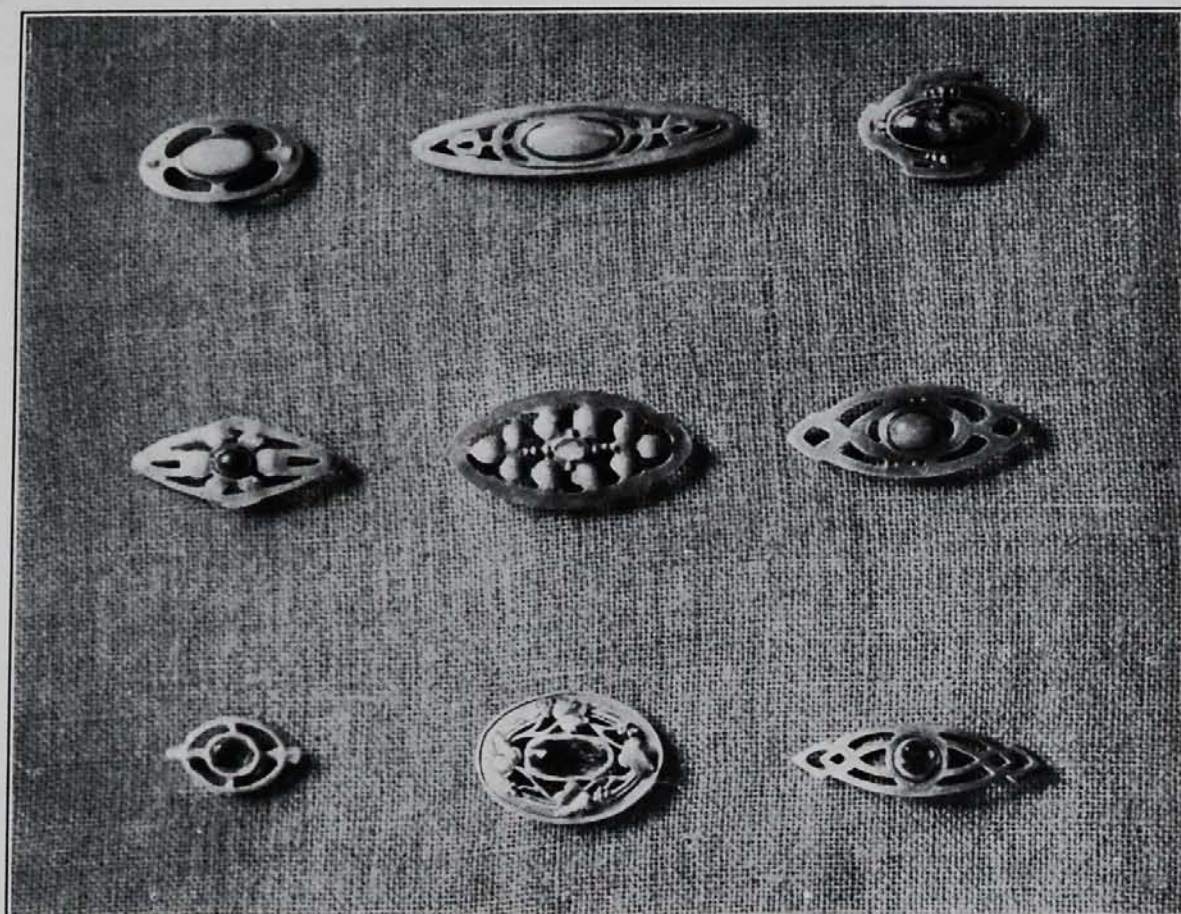
FIGURE 38

metal forming the background of the brooch and soldered in place.

Several small pieces of solder should be placed about the inside of the wire equal distances apart. The bezel should be made and soldered in place as described in Prob. 2. The coil of wire shown about the bezel is made by coiling a piece of No. 30 gauge wire around a small arbor as shown in Fig. P, Plate XXVIII. This may also be done by putting the arbor in a lathe or in a hand drill. After the coil has been made, it is bent around the bezel to get the length and then the ends are soldered. It can also be soldered in place about the bezel at the same time if a little care is exercised.

The eight spirals are next made to fit between the coiled wire and the twisted wire at the outside edge. Take a piece of No. 30 gauge wire and cut eight pieces about $2\frac{1}{2}$ inches long. Now fasten one end of a piece of wire in a pin vise, and bend over at right angles. The vise is turned with the left hand while the wire is held with the thumb and first finger of the





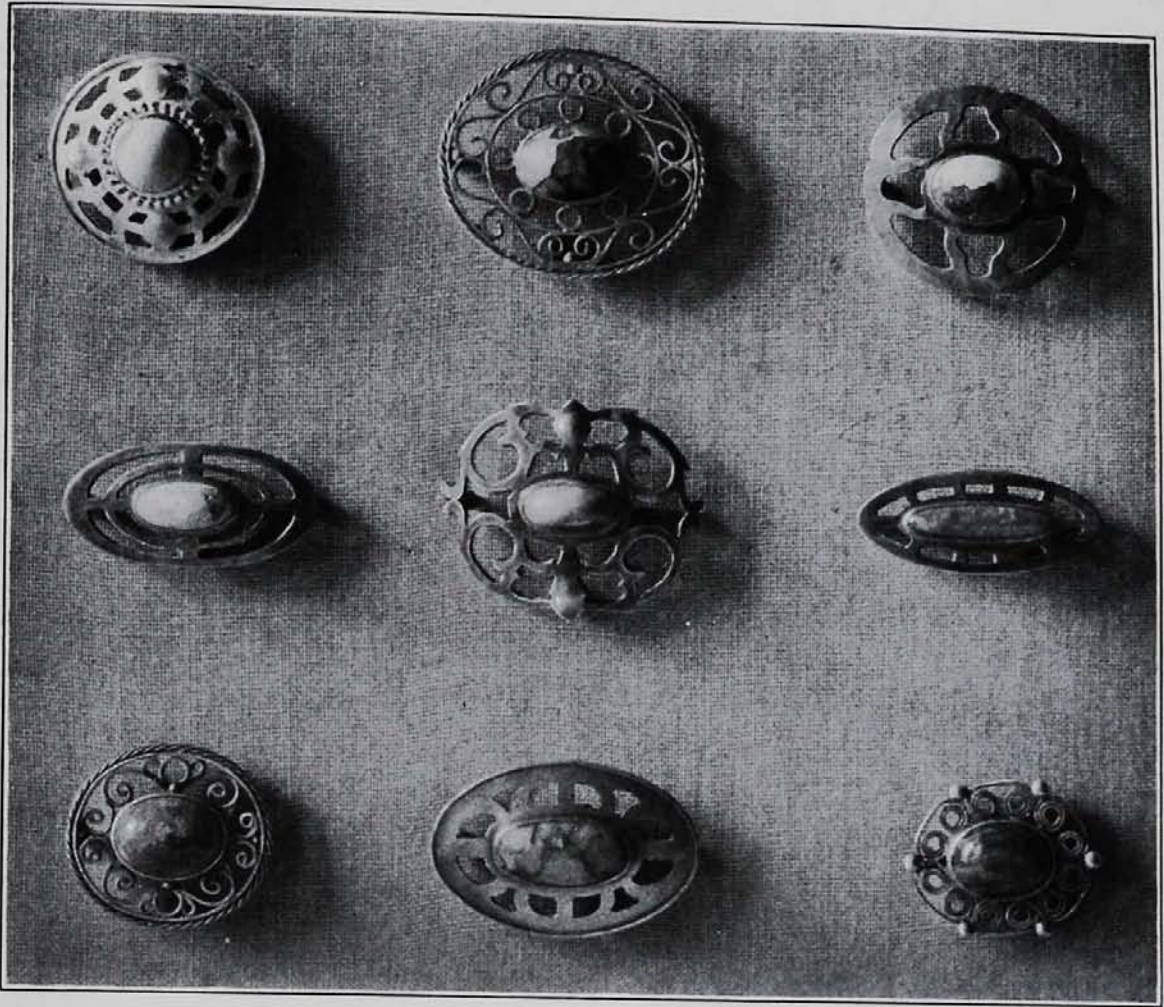


FIGURE 39

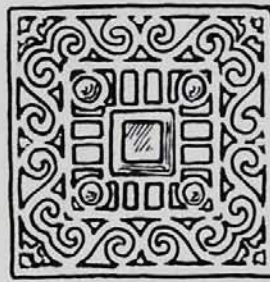
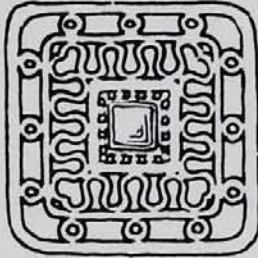
right hand. The vise is turned times enough to give the required number of turns in the spiral; it is then opened and the end of the wire held in the vise is cut off close to the spiral. The spirals are then fitted in place and any extra length on the outside end is cut off. The eight spirals may all be soldered in place at the same time. After using the borax on all parts, several very small pieces of solder should be placed on and about the edge of each spiral. If the heat is applied gradually and the whole brought to the soldering point at the same time, satisfactory results may be expected. The bezel and twisted wire on the edge should be protected with yellow ochre. When the soldering has been done the brooch is pickled. The shot as shown are now made and soldered in place.

The ones forming the center of the spiral are flattened a little on the bottom. If one works carefully all of the shot may be soldered at once. The joint and catch are now soldered at the back and, after the final pickling, the stone is set and the brooch polished.

Fig. 36-A differs from Fig. 36-C in that a beaded wire is used next to the bezel and next to the flat wire around the outside of the brooch, and a small round wire is soldered on the inside of the beaded wire. The three wires give an interesting finish to the edge. In using a combination of wires in this way, much depends on the relation one wire bears to the other regarding size and shape. In Fig. 36-B the decoration is obtained by applying four small pieces of metal in the shape of leaves, these being connected with a piece of wire in the form of a stem, and a few shot suggesting berries. The only thing new in this illustration are the leaves which are cut out of No. 24 gauge metal and shaped up from the back with dapping punches on a block of lead, Fig. 23-B. After they are shaped up they are filed off flat on the back and then, by using a three-cornered file, a vein or mid-rib is suggested on the face of the leaf. In this particular case a square wire was used for the stems. When the leaves, stems and shot are all made they are put in place and all soldered at the same time.



BROOCHES 'W WIRE

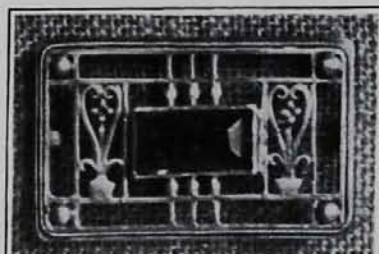


Chapter IX

Brooches Made of Wire



A



B



C

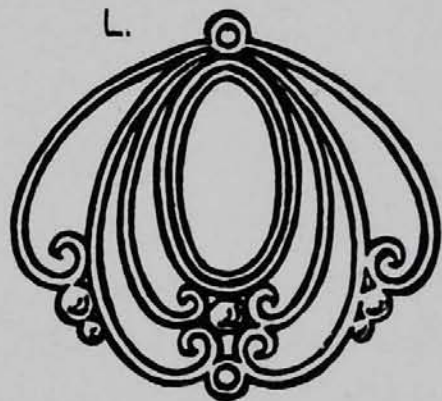
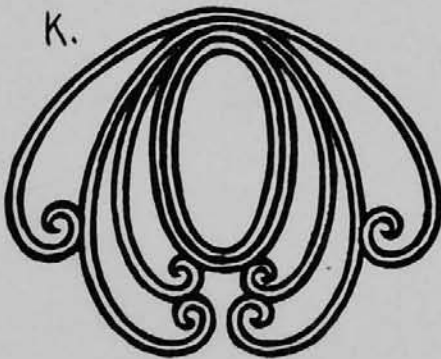
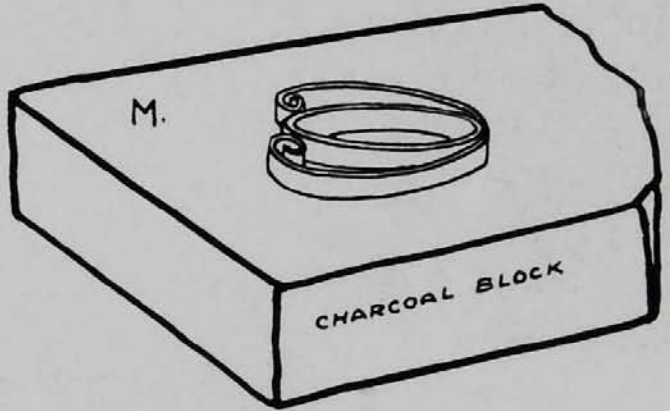
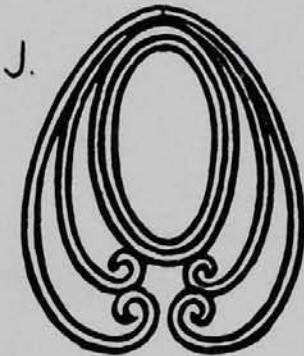
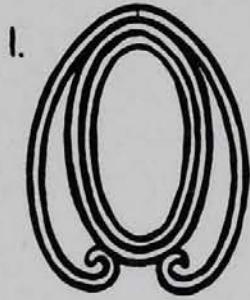
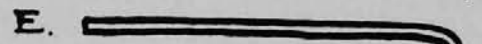
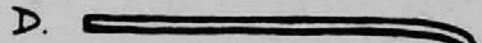
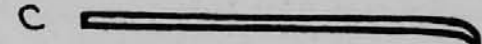
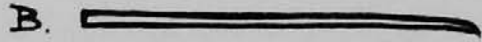
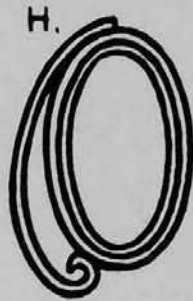
FIGURE 40

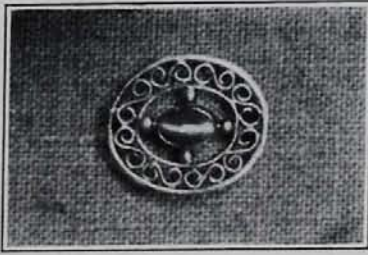


FIGURE 41

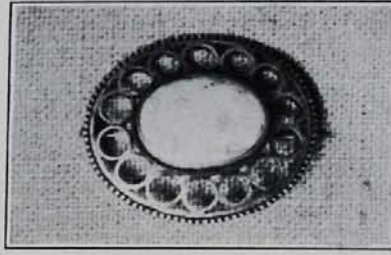
PROBLEM 7. In describing this problem the pendant, Fig. 41, will be used to illustrate it because of its being very simple in outline and having few details. When the student is able to do the wire work illustrated in this figure and do it well, he will be able to produce more complicated pieces for most of the pieces of jewelry made up of wire are simply repetitions of different units. In this as in most cases a stone is the central feature around which the design in wire is carried out. We will then take a cabochon cut stone. In this particular problem a turquoise matrix was used. The next step is to make a box or setting for the stone to rest in; this is done by making a bezel or band, using No. 24 gauge metal as described in Prob. 2. When the bezel has been made and shaped to fit the stone, it is soldered to a piece of metal the same thickness and just a little larger than the bezel. After the soldering is done and the box is pickled, the metal outside of the bezel is cut away, cutting with the saw just a little outside of the bezel and then filing flush with the bezel.

PENDANT IN WIRE

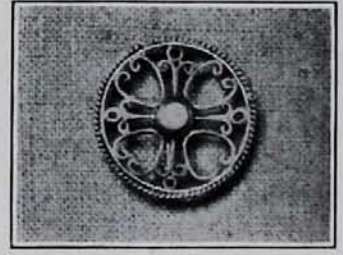




A



B

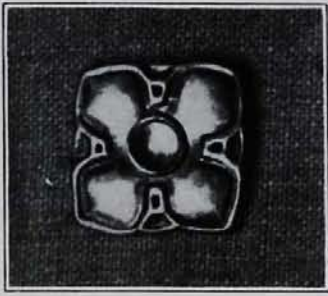


C

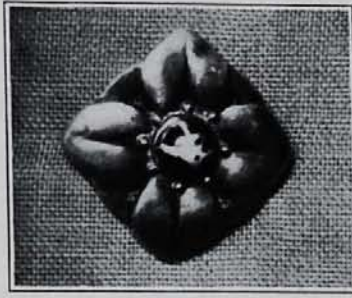
FIGURE 42

We are now ready to use the wire which for this problem will be rectangular, No. 15 x 22 (.057 x .025) gauge. It will be noticed that this design, Fig. 41, is composed of three pieces of wire with scrolls at one end varying a little in size, and these three being repeated on either side of the stone. To make a good scroll is not an easy thing and considerable practice on the part of the student will be required. One must first come to an appreciation of the scroll through the drawing or design work, so it will be assumed that this most important lesson has been learned. Assuming that we know a good scroll when we see it, the next thing is to produce one.

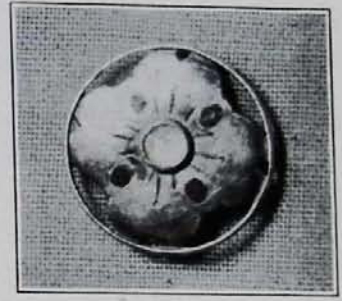
Take a piece of wire the size mentioned above and about one and one-eighth inches long and point one end with the file, Plate XX, Figs. A and B. Now with the round-nose pliers, hold the wire at the extreme end and by two or three turns with the pliers the scroll is started. Fig. C. The pliers are then moved back a little and another turn is made as at Fig. D and so on till it is shaped as at Fig. E. We now take the round-nose pliers in the left hand and with the chain pliers in the right hand the scroll is completed. Fig. F. Holding the tools and wire in this manner enables the student to produce a scroll with an unbroken line from the beginning. As stated before, this little operation will have to be repeated many times before satisfactory results are obtained, but when mastered the most intricate design can be produced. Now to return to



A



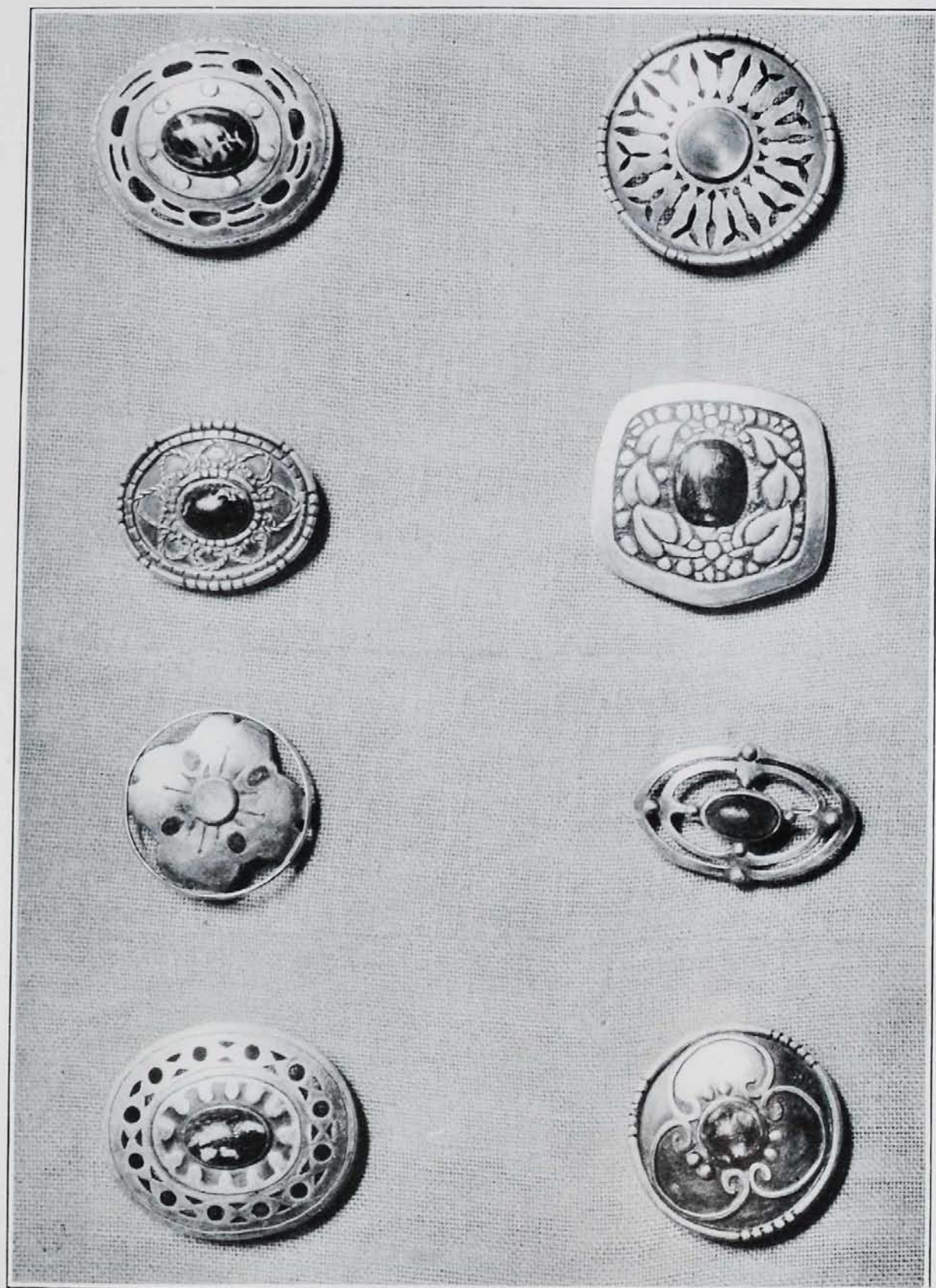
B



C

FIGURE 43

Fig. 41 we will make the two scrolls that appear next to the bezel. After they are made and cut the right length they are soldered in place as at H and I. At the top a part of the thickness of the wire is filed away to make the scroll appear to grow out of the setting; otherwise, when the other two scrolls are applied, it would be very heavy at this point. The next two scrolls are then made and soldered in place as the first two were. Fig. J. The scrolls may be held in place while being soldered by using short pieces of iron wire placed next to the work and pressed into the charcoal block. While soldering a problem like this it is very important that the work rest on a level surface, so the charcoal block should be faced off from time to time, either with a large flat file or with a board covered with sand paper kept at hand for the purpose. The middle scrolls are reduced at the top as the first two were and the outside ones are made and soldered in place as at Fig. K. The last two are also filed a little at the top. After pickling, the piece of work is faced off at the back by placing it on the flat file and moving it back and forth a few times, holding it with the fingers of the right hand. If the soldered joints are irregular on the front side of the piece of work they may be filed a little with the flat file, keeping the safety edge next to the bezel to prevent reducing the thickness of the bezel. The shot as shown in the illustration are made and soldered in place. The rest of the parts of the pendant will be described under pendants.



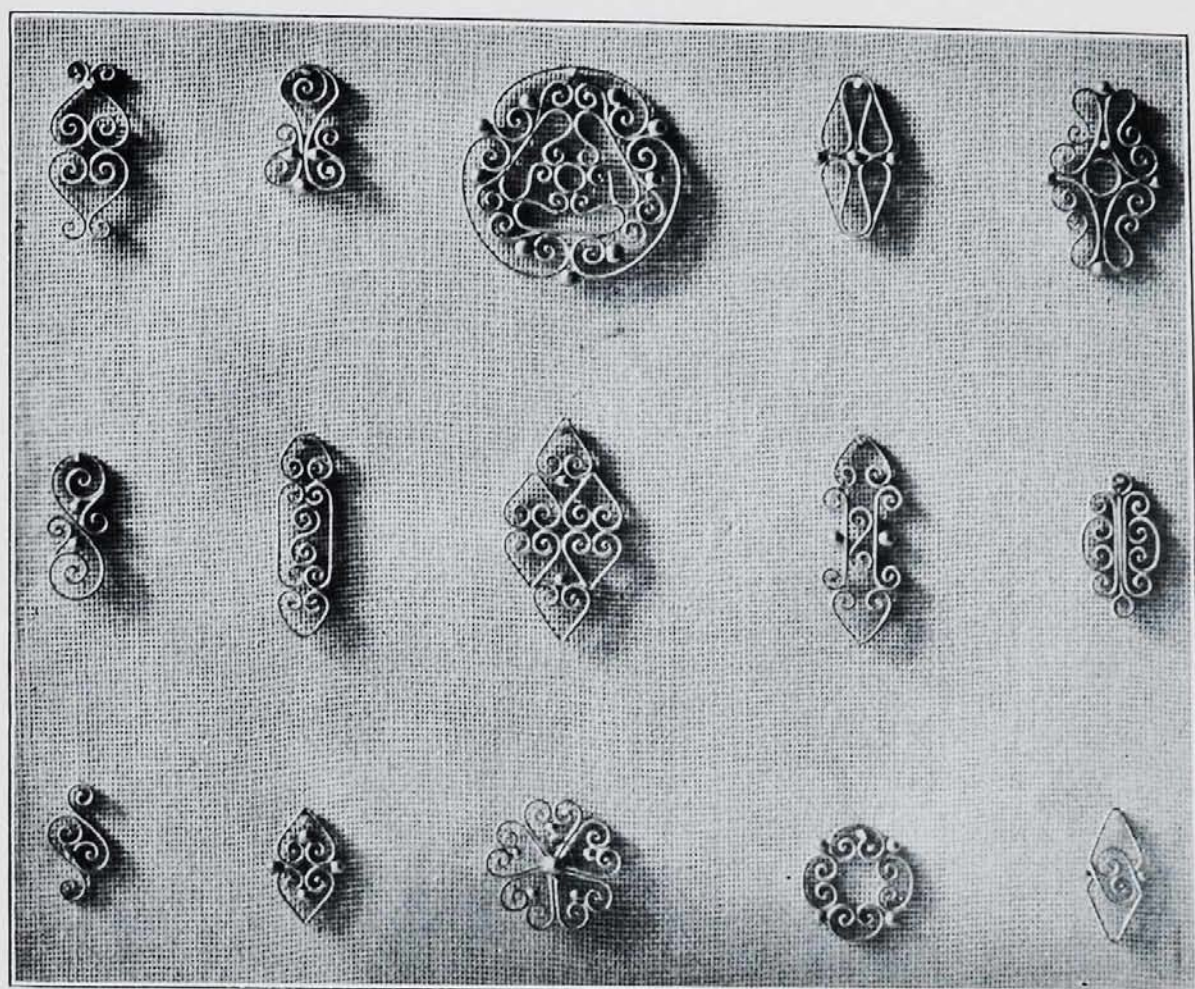


FIGURE 44

Fig. 40-A, B, C and Fig. 42-A, B, C can now be worked out being to a certain extent a repetition of the problem illustrated on Plate XX. In each of these figures, after the bezel is made for the stone, the outside frame is made and the other parts worked in between. In Fig. 42-B after making the bezel and the outside frame, the inside is made of a series of circles or small rings of uniform size. These are made by taking a piece of wire the required size and coiling it over an arbor of the right size. This coil is then sawed apart giving us the required rings. These are then placed on a surface plate and by tapping each one lightly, the ends are brought in line, or it may be done with the chain pliers, holding a pair in each hand. All the rings are placed on the charcoal block and are all soldered at once. After pickling, the joints are trued up with the file. The

bezel is now placed in the center of the charcoal block and the frame outside of it. If the rings are made the right size, they can now be dropped into place and, after all parts are carefully adjusted and boraxed and a piece of solder placed over each point of contact, the whole is soldered. After pickling, the front and back are faced off, using the flat file. A little more life may be given this piece by doming it as the pierced brooch was domed

Fig. 40-B differs from those just described in that a faceted cut stone is used and in that a large part of the brooch is made up of straight lines, requiring more accurate work. At first we must make what is called a shoulder bezel. Where the stone is transparent and cut as at Fig. B the back of the setting must be left open so that the bezel is made with a shoulder on which the stone rests. To make the bezel in this way two strips of No. 24 gauge metal are needed about 3 inches long, one $\frac{1}{4}$ -inch wide and the other $\frac{1}{8}$ -inch wide. These two strips are first soldered together. Before soldering, the two surfaces coming together should be cleansed or scraped bright and then coated with borax; and, after placing one over the other, they are bound with wire to hold them in place. Several pieces of solder are then placed at intervals along the edge and the two are soldered together. This gives us a strip of metal with a shoulder from which the bezel is made. Next make the outside frame, being sure that the opposite sides are equal and the angles right angles. The rectangle should be the same proportion as the stone. The next step is to solder the two bars that run from end to end. The ends of these strips should be filed squarely to make sure of a good joint. Now solder the vertical set of wires. Care should be taken always to have right angles and the student should avoid using too much solder. In working with the shortest pieces of wire they can be handled by holding

BROOCHES IN WIRE



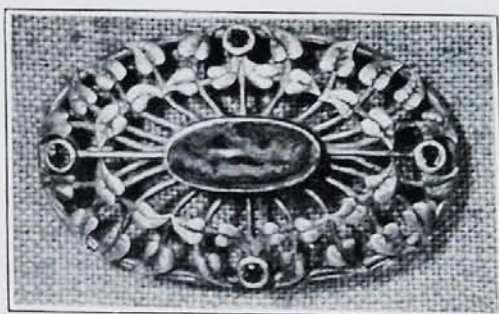
them in the flat-nose pliers. The student will save time in working out this problem if like operations on like pieces are done at the same time. The short pieces should all be soldered at the same time. In placing the wire the student will find it helpful if he devises some method of holding the brooch firmly on the charcoal block. Short pieces of wire will serve the purpose as described in the preceding chapter. When soldering several pieces at the same time the student will get good results if a fairly large flame with a good mixture of air is used; in other words, a soft flame. When soldering the two strips that hold the bezel they should be placed so that the bezel will fit tightly. The bezel should be dropped in place to make sure of a tight fit before attempting to solder.

Now make two pieces like flower pots as shown of about 20 gauge metal and solder them in place. From the same rectangular wire make four scrolls to fit in place, and solder. Add the two smaller pieces and solder them. Now solder in the short vertical piece. This should be filed wedge-shaped at the bottom end to make a good fit. The four shots are made and first soldered together upon the charcoal block and then soldered in place. If the group of shot does not fit, the vertical wire can be filed a little until it does fit. The bezel is now put in place and soldered at each end after which shot are made to fit next to the bezel at the top and bottom and at the four corners of the brooch. All the shot should be soldered at the same time. To avoid unsoldering joints already soldered it is advisable to coat them with yellow ochre.

The outside of the brooch now looks very weak in design. To overcome this the brooch is soldered to a piece of flat stock of about 20 gauge. This piece should be larger than the brooch by about 1-16 of an inch all around. The center is first sawed out so that the inside dimensions of the rectangle are equal to



A



B



C

PROBLEM 8, FIGURE 45

the inside dimensions of the outer rectangle of the brooch. The brooch is then soldered to this piece.

A piece of 26 gauge fancy wire, either twisted or beaded, is soldered in the corner next to the rectangular wire and upon the flat piece just soldered, adding much to the finish of the edge. Now solder catch and joint; pickle, set stone and polish.

PROBLEM 8. In Fig. 45-A, B and C natural elements have been introduced in the form of leaves and flowers. In Fig. 45-A the bezel is made as described in Prob. 7. Then two frames are made of round wire, one larger than the other and soldered together, with shot forming the point of contact. The leaves and flowers are made from No. 24 gauge flat stock. After cutting them the required shape with the saw they are placed on the lead block and are dapped up with the dapping tools. The outlines are finished with the file and the little stems which are made of small round wire are soldered to them at the back of the leaf. The stems are bent to fit and, after all the parts are fitted in place, the whole is boraxed and small pieces of solder placed at each point of contact and soldered.

In Fig. B the work is much the same as in the preceding figure. The leaves are made in the same way and soldered to the stem, first a stem with three leaves and then one with one leaf. In this figure four small stones will be noticed at the ends of the long and short diameters of the brooch.

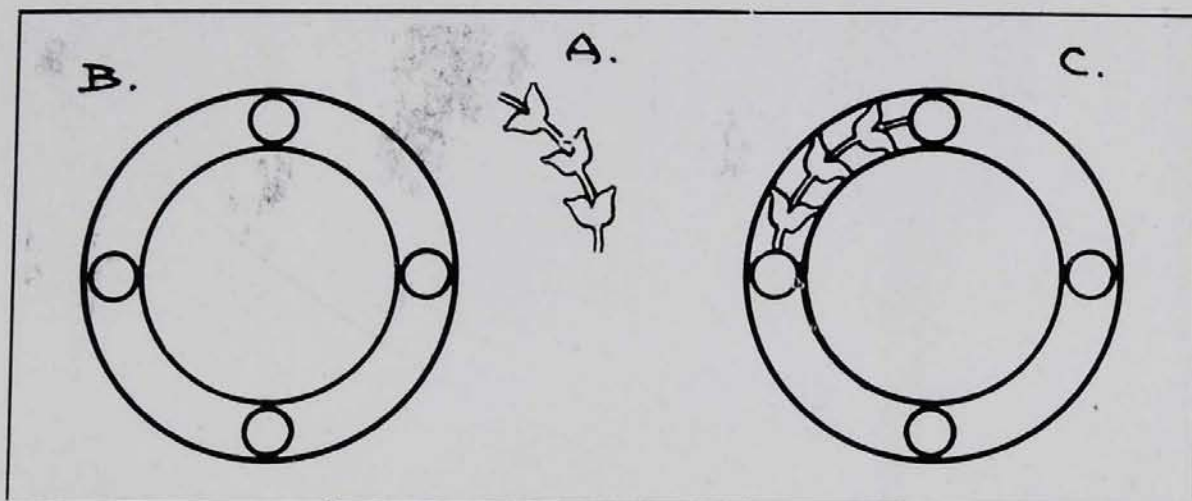
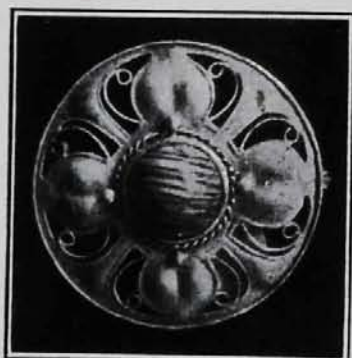


FIGURE 45-A

In Fig. 45-A the leaves are made as follows: Lay out the entire design on a piece of No. 24 gauge metal, being very careful in the drawing of the leaves. Use a No. 0000 saw to cut to the outline of the leaves. When this is done, turn the metal over, place on a lead block, and with very small punches model the leaves as shown. In this case the leaves and stem are all in one piece and when filed up and cut apart appear as at Fig. A. The settings are now made for the four stones. A piece of rectangular wire is used for the inside and outside rims. After making the rims the settings are soldered in place as at Fig. B and then the leaves are fitted and soldered in place, Fig. C. Each leaf should come in contact with either the outside or inside rim.

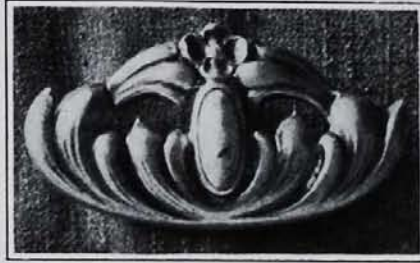


Chapter X

Brooches, Chased and in Repoussé



A



B



C

PROBLEM 9, FIGURE 46

PROBLEM 9. Fig. 46-A, B and C show brooches produced by the repoussé or embossing process.

The principle is the same as modeling in clay or wax, the only difference being that metal is used as the material and that different tools are employed. In this, as in clay or wax work, the object is to bring certain parts of the design into relief; to do this with metal the work must be placed on a substance that gives some resistance and yet allows each blow of the hammer or tool to make an impression. The substance commonly used for this purpose has the following composition in the proportions given:

Black pitch	1 lb.
Tallow	3 teaspoonfuls
Plaster of paris	$\frac{1}{2}$ cup

The pitch is put in a dish, placed over a gas plate and melted. The tallow is then added and the plaster stirred in gradually, the whole being well mixed. It is then poured into the pitch pot and allowed to cool. When used in hot weather more plaster will be needed.



FIGURE 46-D

The pitch pot, Fig. 46-D, is hemispherical in shape, made of cast iron about $\frac{1}{2}$ -inch thick. This, when placed on a chaser's pad, may be turned at any angle. The tools necessary for this work may be made as needed according to each individual design. There are a few general ones that are always found

useful. A hammer usually used for this work is shown at Fig. 1, Plate LI, page 238.

We are now ready to take up the problem. In Fig. 43-A No. 24 gauge metal is used. The design is carefully drawn or transferred on the metal and then lightly scratched with a scratch awl to make the drawing more permanent. The pitch is now slightly warmed on the surface and the metal placed on it. After it has cooled off we are ready to carry out the design, which, in this case, is to be in repoussé.

First take a small narrow tool, and holding it as shown at Fig. 46-E, carefully follow the outline of the design. By using the chasing hammer and striking the tool with a repeated number of uniform light blows a channel is made in the metal; and, when we reverse the piece of work, we shall find that a line has been raised around the outline of the brooch as noticed in the illustration. It will also be noticed that the four petals or leaves radiating from the center are to be raised slightly. This is done with a larger tool slightly convex. After the tooling is completed, we are ready to remove the work from the pitch. Take the blow-pipe and warm the metal slightly, just enough to soften the pitch, and it will be found that the work can be lifted with a pair of tweezers. Some of the pitch will adhere



FIGURE 46-E

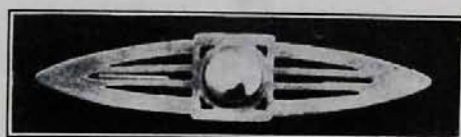
to the work, but it is easily removed by rubbing over it while it is warm with a cloth dampened with kerosene. After it is cleaned, if we find that the embossing is not quite satisfactory, it can be placed back on the pitch again and worked over to improve it.

When the tooling is satisfactory a bezel is made for the stone and soldered in place. The stone in this case was a moonstone. Figs. B and C are done as Fig. A except that the tool was used on the face as well as at the back. The lines that form the mid-ribs or veins of the leaves were made by using the tool on the front side of the brooch; when the tooling is done on the face of the work, it is called chasing. Fig. 46-B and the pendant on page 139 are examples that show the technique and results obtainable. These results are obtained, however, only after long and continued



FIGURE 47

practice. Figs. A and C, also Fig. 47 show problems carried out in interlacing. The design is laid out on the metal as previously described and, after placing the work on the pitch, it is chased. The entire outline of the design is followed first with a rather pointed or V-shaped tool, sometimes called a liner, then a larger tool the required width is used to go over the parts that appear to go one over the other. After the chasing is done, the open parts are cut out with the saw and the edges finished with the file. In this problem it is better to bevel the edge a little, rather than have it vertical. After the chasing, sawing and filing are completed, the bezel is made and soldered in place, also the joint and catch at the back. The stone is then set and the brooch polished.



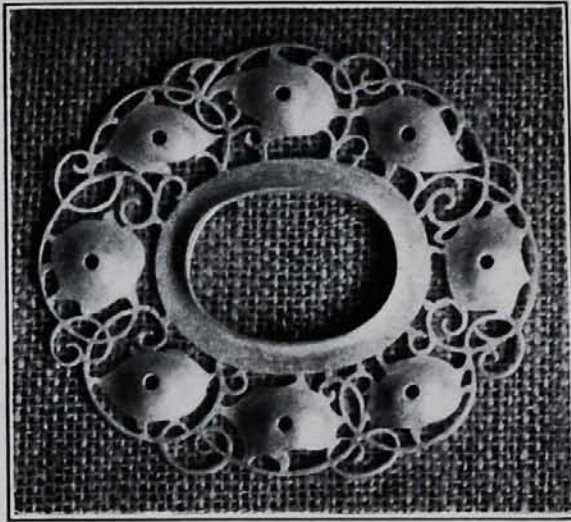


FIGURE 48

The settings for the stones are made differently from those previously described. Before making the small triangular piercing, next to the large stone, make an opening in the centre of the piece of metal the shape of the large stone but one quarter of an inch less in diameter. Then place it over an arbor and the metal about the edge of this opening is turned from the inside up by hammering and stretching. This forms the bezel, Fig. 48. The small piercings next to the bezel may now be drawn, sawed and filed into shape, Fig. 49. Now place the metal front side down on the lead block and dap up the leaves about the edge with a good-sized dapping tool. Drill a hole in the center of each leaf, using a drill about one-sixteenth of an inch less in diameter than the size of the stone. As the stones vary in size, each one will have to be fitted separately. After making the openings for the stones about the right size, a shoulder is cut around each opening to make a seat for the stone.

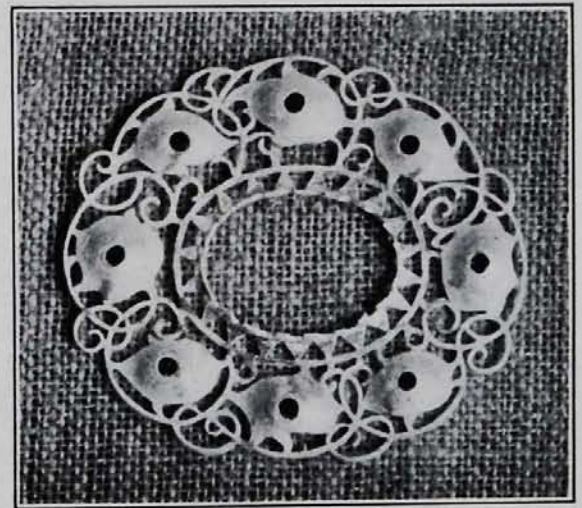


FIGURE 49

PROBLEM 10. A brooch with several stones may be carried out as shown in Figs. 48, 49 and 50. A piece of No. 18 gauge metal is used for this problem. The design is first carefully drawn on the metal and then pierced with the saw. A piece of work of this nature requires very careful filing after the sawing is done.

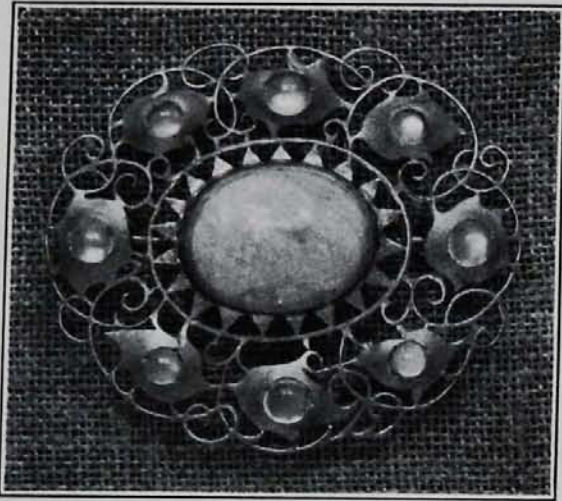


FIGURE 50

As cabochon stones with flat backs are used in this particular instance, the shoulder is cut flat. When each one of the small stones have been carefully fitted and numbered, the setting for the large stone is carried farther. From a piece of flat stock about No. 24 gauge and three-sixteenths of an inch wide, make a ring large

enough to fit inside of the opening for the large stone. As it is necessary to have a good snug fit, the ring can be made just a little small at first and stretched to fit. This ring is soldered in place keeping it about one-sixteenth of an inch below the top of the edge forming the bezel. This makes the shoulder on which the stone rests. The joint and catch are now soldered in place and the stones are set after the brooch is polished. The large stone is set as previously described after placing it on the shellac stick. The small ones are set by using a small half round engraving tool, turning the metal over the edge of the stone at four points. Upon close examination of Fig. 50, the marks of the engraving tool may be seen. In this type of setting the stone must fit the opening perfectly.



The Hat Pin

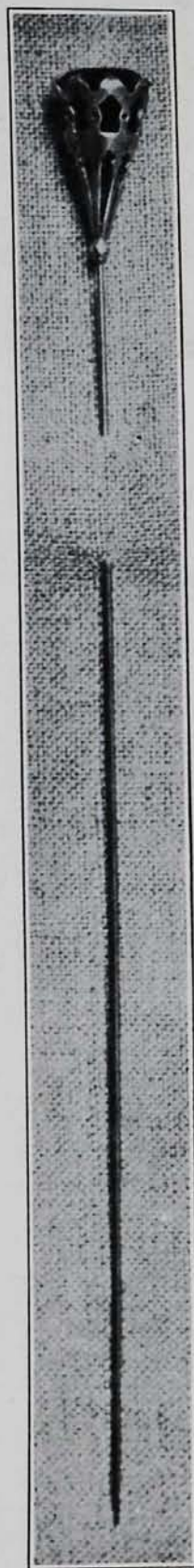
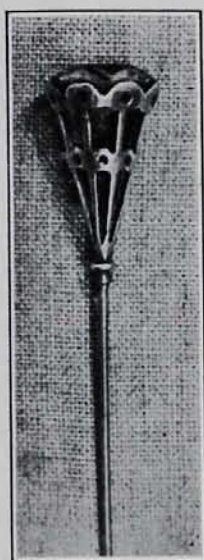
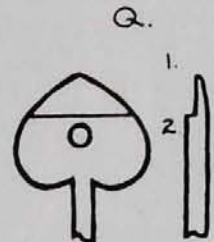
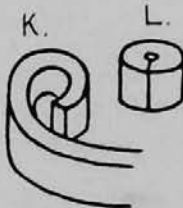
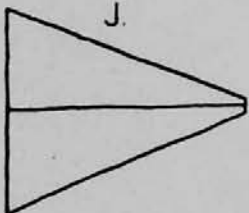
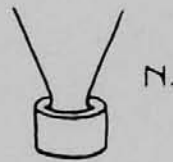
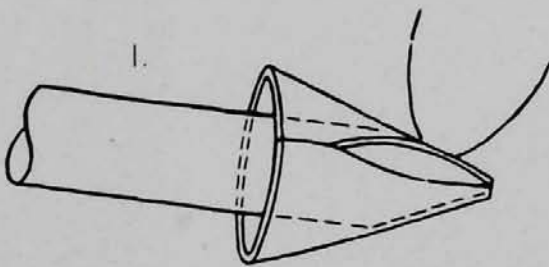
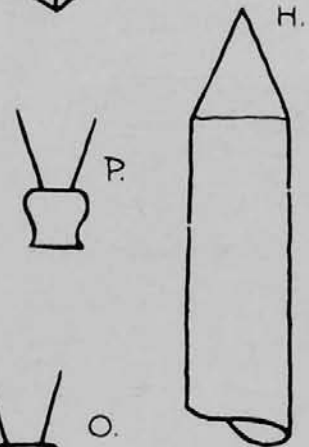
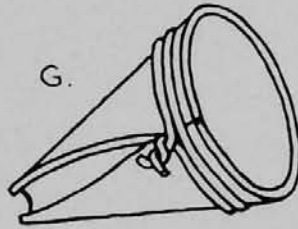
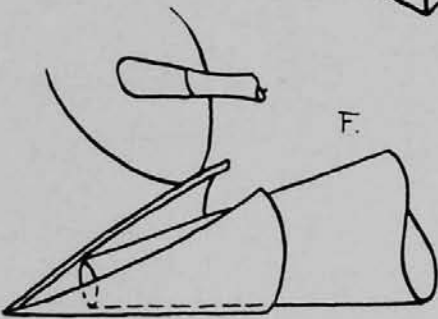
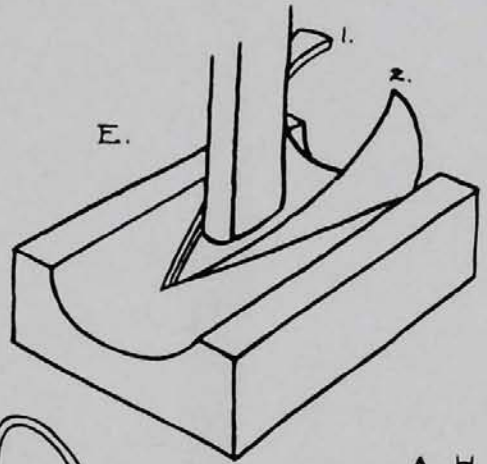
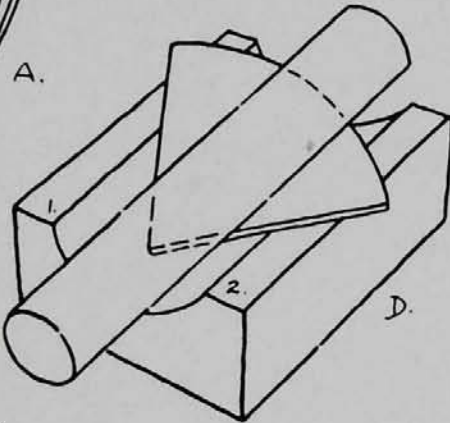
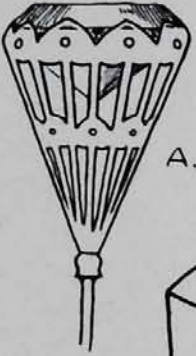
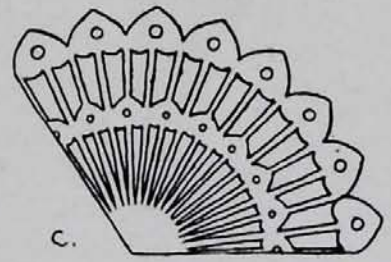
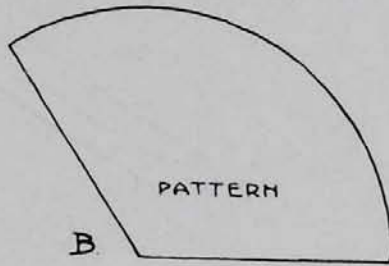
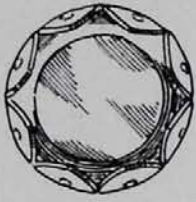


FIGURE 51

PROBLEM II. To make the hat pin as illustrated, Fig. 51 and on Plate XXIII, secure a circular stone about $\frac{1}{2}$ " in diameter, either faceted or cabochon cut. Make several designs with small perforations as illustrated at Fig. A. The small openings are preferable to the large as the metal is less likely to break in the bending. When a satisfactory design has been made, make a pattern of the cone as shown at Fig. B. To make this, first take the slant height of the cone as a radius and describe a semi-circle. On this semi-circle lay off the diameter of the stone three times as a chord. On this pattern trace the unit of design as shown by Fig. C. Make a tracing of this pattern and glue it to a piece of No. 18 gauge silver. The sawing and filing are now done. After all of the edges are filed, the metal is ready to be bent into shape. Take a block of lead and with a gouge cut a concave form as shown at Fig. D and indicated by line 1 at 2. The metal is now placed on the block and, with a cylindrical mandrel and mallet, the form is curled up.

Fig. D shows the position of the metal on the lead block with the mandrel in place. In all the illustrations where the pattern of the cone is used the design is not shown as it is not necessary to the explanation of the processes. The mandrel is used as

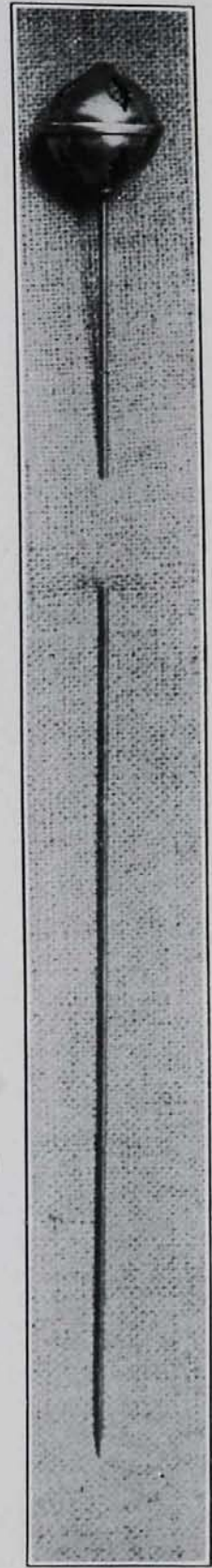
HAT PIN



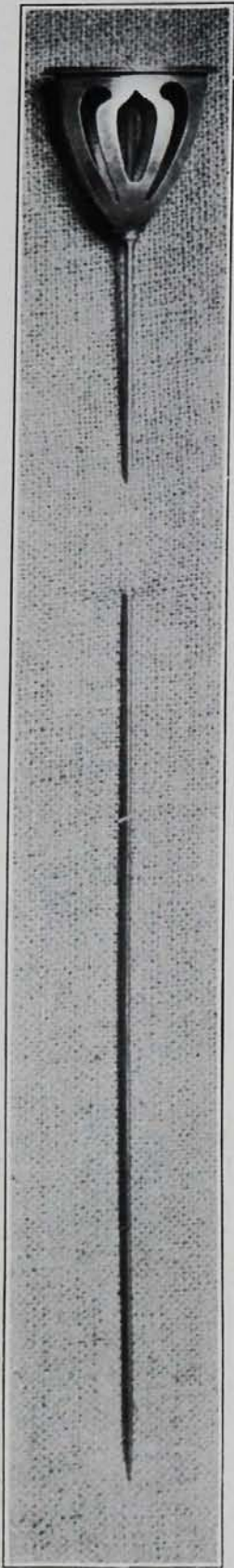


much as possible except when it becomes necessary to resort to another tool like that in Fig. E. By tapping the tool lightly and turning the cone a little each time, the edges of the cone at 1 and 2 come within about $\frac{1}{4}$ of an inch of each other. The form is now placed over a cone-shaped mandrel which is firmly fastened in a vise, Fig. F, and the edges are brought still closer till they touch for about $\frac{1}{4}$ of an inch or more along the edges as shown by Fig. G. The extreme point of the cone may be cut off at this time. After the edges have been scraped and boraxed, bind the cone with wire as indicated by the same Fig. G and then solder. We solder only enough of the seam to facilitate the rest of the bending. To do the rest of the bending it becomes necessary to make a tool that will just fit inside the cone as Fig. H.

To make this tool, take a cylindrical piece of steel about $\frac{5}{8}$ " in diameter and point one end on an emery wheel till it fits snugly into the cone. Fasten this tool



firmly in the vise and place the cone over it. Take the mallet and bring the edges together as shown by Fig. I. After the edges butt, as indicated by Fig. J, it is



ready to be soldered. The seam along the inside of the cone as well as the outside is well boraxed and soldered. It is then pickled and the joint filed into shape.

Now take a piece of metal about No. 16 gauge and about 3-16" wide of any convenient length and with the round-nose pliers bend as shown at K, then saw and butt ends at L, and solder. This form is to help strengthen the hat-pin stem. It is now wired about the apex of the cone and soldered as shown at M. As there is very little surface to be soldered it is well to flush the joints as indicated by N.

The dotted lines in O show that the piece soldered to the apex has been drilled as far as the hidden lines indicate, and the drill used was a little larger than the thickness of the hat pin stem. The hat pin stem is of Nickel silver and any length. The little support is now filed to shape as shown at P.

Fig. Q is a two-view drawing of one of the prongs. The end view shows the part cut away to make a shoulder for the stone to rest on. This is done with a three-cornered file and the depth 1-2 is about $\frac{1}{8}$ "—just enough to turn onto the stone. Having filed each prong to about half the thickness of the metal the stone is ready to be set. The filing of the prongs is best done when the pattern of the cone is in the flat as Fig. C.

Now holding the cone between the opening of the bench-pin the stone is inserted and each prong is pushed over gradually, using the same tool as was used



before in stone setting. In the setting of the stone the same precautions must be taken as in previous problems. Always push opposite prongs alternately to avoid throwing the stone to one side. After the stone has been firmly set and the points of the prongs pressed well down with the burnisher, the hat pin stem is ready to be soldered in place. Soft solder is used here because the amount of heat used to melt the hard solder would render the stem soft and hence impractical. The end of the stem is scraped and covered with the soft soldering fluid. A little of the fluid is also placed into the hole of the stem support. The stem is inserted and soldered. Here again plenty of solder must be used to secure a firm hold for the stem. The hat pin is now ready for the finishing and polishing.

PROBLEM 12, Figure 52. A piece of No. 24 gauge metal 1" in diameter is needed to make this hat pin head. Place the metal over the lead block, Fig. 23-B, and

using the small end of the chasing hammer dap it up in a cup-shaped form. The edge is trued up with the file and after annealing, the cup is soft soldered to a piece of sheet copper or brass for convenience in handling. As it is necessary to fill the cup with chasers' cement, a hole must be left in the piece that is soft soldered to the



FIGURE 53



FIGURE 54

bottom. The cup is then filled with the cement and allowed to cool. It is next placed on the pitch block, Fig. 46-E, and with the use of the chasing tools it is worked into shape, Fig. 54. In working out a problem of this kind it is well to take a little wax and model the design before starting the chasing as shown at Fig. 53. After the chasing is done the

cement is run out and the cup is unsoldered from the piece of metal at the bottom. The cup is cleaned and the edge is again filed to remove the soft solder. Now take a piece of No. 16 gauge metal a little larger in diameter than the cup and hard solder it to the bottom. A little fillet may be filed about the edge of this piece to remove a little of the thickness. A setting is then made for the stone and the pin stems soldered in place. The stone is set and the pin finished as desired.



Scarf Pin

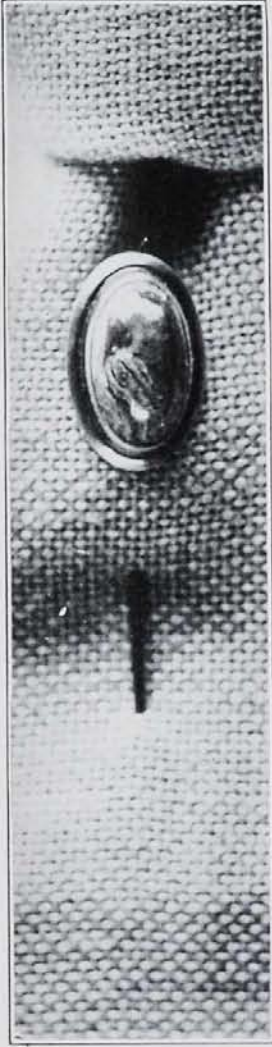
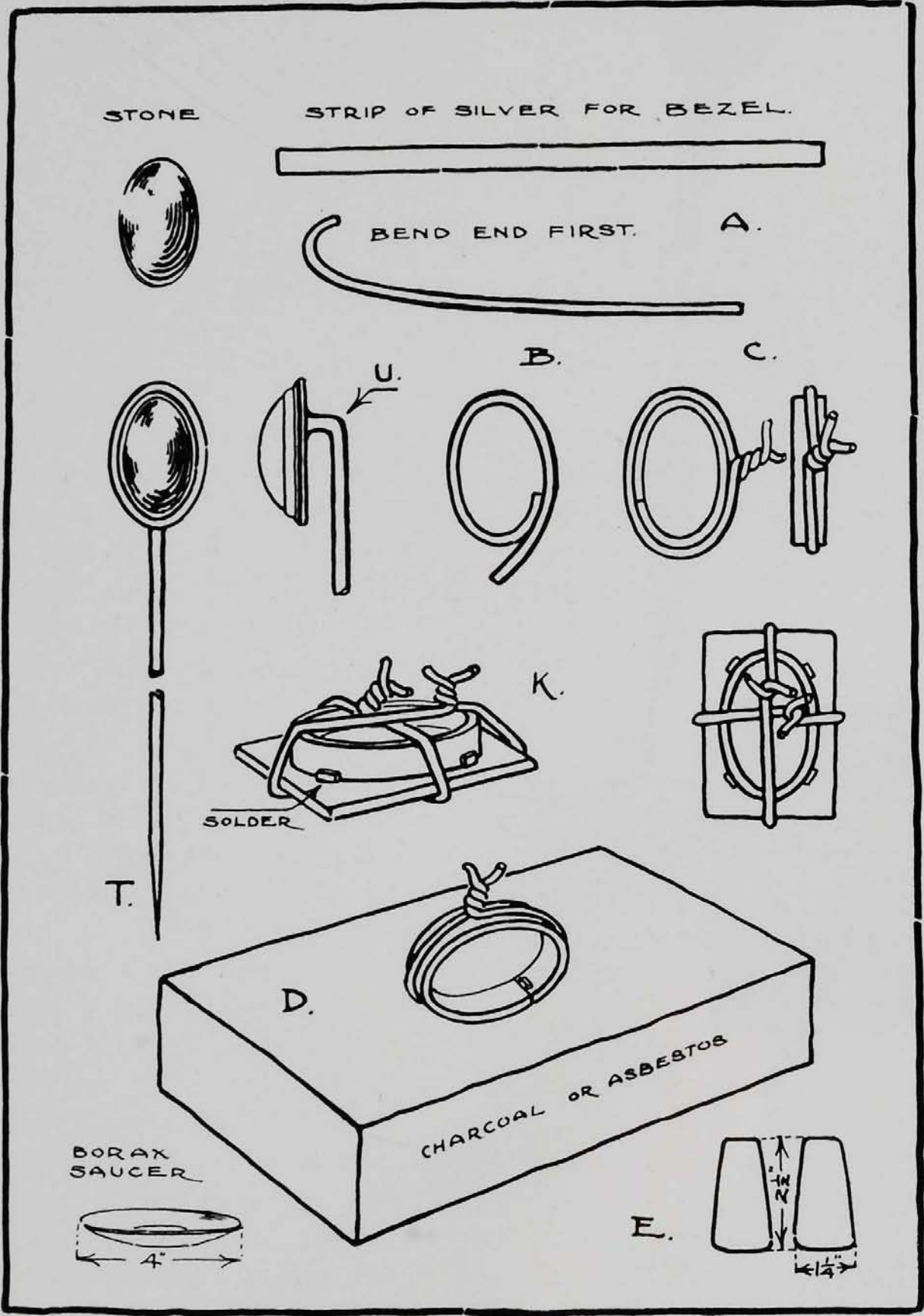


FIGURE 55

PROBLEM 13, Fig. 55. The essentials of a scarf pin are a stone, precious or semi-precious, a setting and a pin. The size and shape of the setting are determined by the size and shape of the stone, so that it is necessary from the beginning to have the stone. There are many ways of making settings, but only the simplest will be described here. To make the setting for this pin, cut a strip of 26 gauge silver about one-eighth of an inch wide and long enough to go around the stone. Using the round nose pliers, bend one end of the strip, first as shown at A, Plate XXIV, and then as shown at B, making it fit the stone closely. With the shears cut off the end that laps over, leaving the strip in the shape shown at C. The joint is then soldered.

After removing the wire, the ring is pickled, washed in clean water and dried. The joint is then filed inside and out to remove surplus solder. For a little further practice before going back to the setting for the pin, the ring we have just made may be soldered to a piece of silver as shown at K, Plate XXIV. Cut a piece of 20 gauge silver about one-quarter of an inch larger than the size of the ring. File one side of the ring flat. Place the ring on the flat piece of silver keeping the distance from the ring to the edge about equal on all



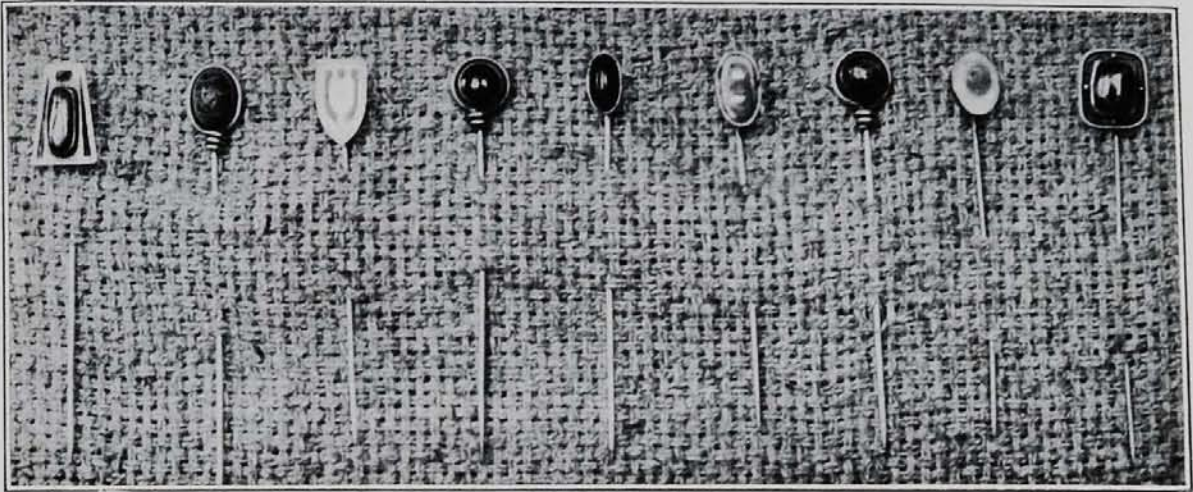
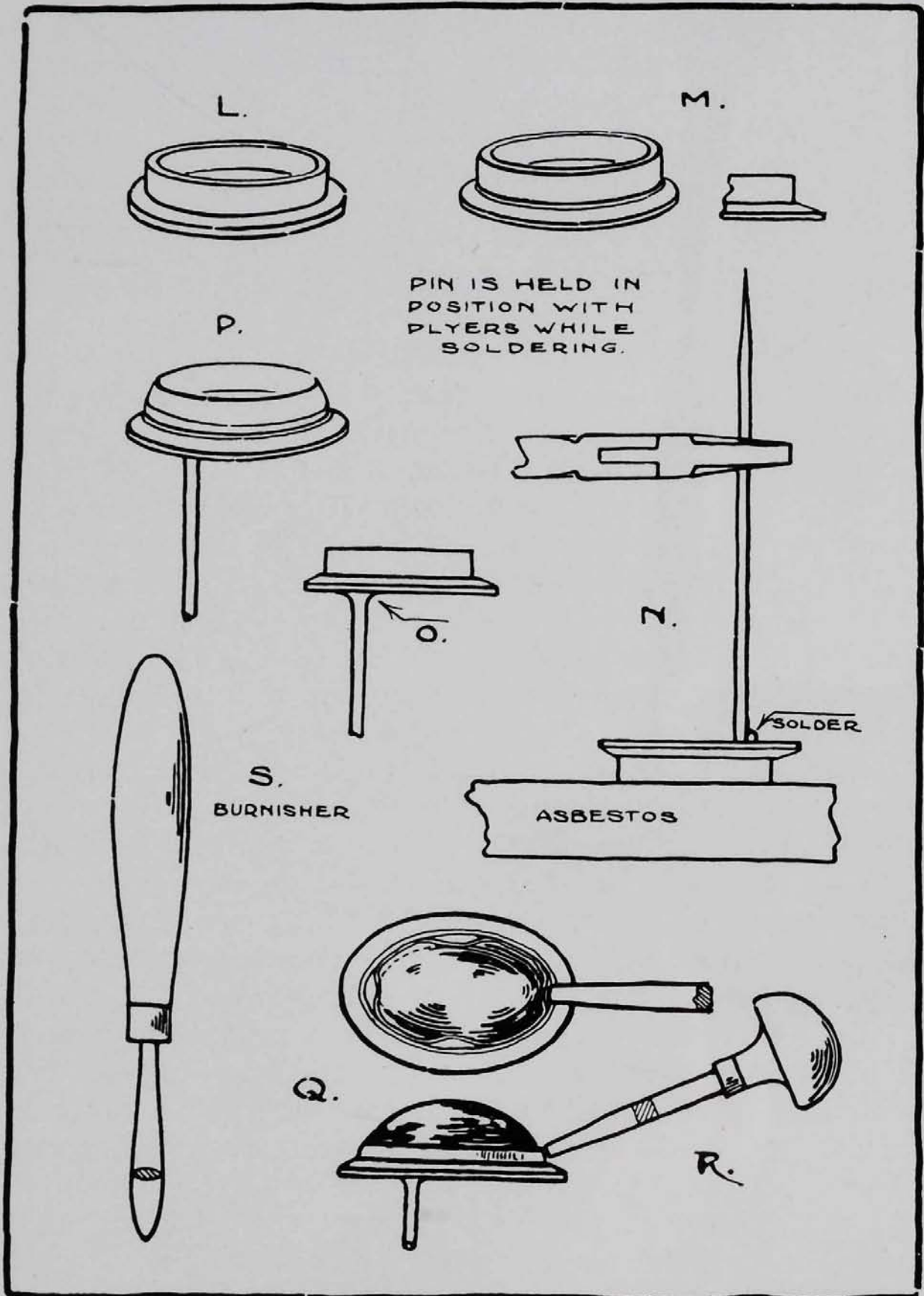


FIGURE 56

sides. Mark around the ring, leaving a line on the flat piece. Remove the ring and scrape bright the portion where the joint is to be. Coat the scraped part with borax, also the filed face of the ring, and place them together and bind with wire as shown at K. Cut four pieces of solder about the size of the first piece used, coat with borax and apply at equal distances about the ring, either on the inside or the outside. The flame is then applied and the silver is soldered as before.

It is then pickled to clean it and remove the borax. Next, saw around the bezel, leaving a little over one-sixteenth of an inch all the way around, as at L, Plate XXV. The joint is now filled up and the edge filed true and then beveled a little as at M. The wire for the pin is now straightened and one end soldered to the back of the setting a little above the center, N. Clean the place where the joint is to be, coat with borax and place a small piece of solder close to the wire as at N, which is held in position with the pliers. The flame is applied till the solder flows all around, making a good strong joint as at O. It is again pickled for the last time.

The outer edge of the bezel at the top is next beveled or filed to an edge, P, to do away with unnecessary thickness. The stone is next put in place and the bezel burnished over the edge.



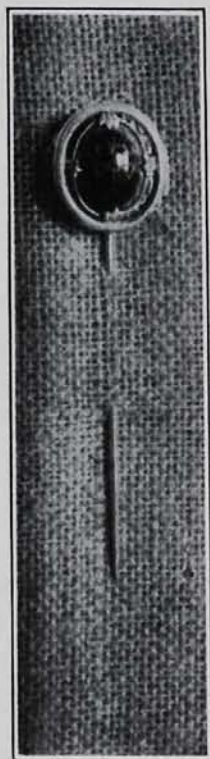
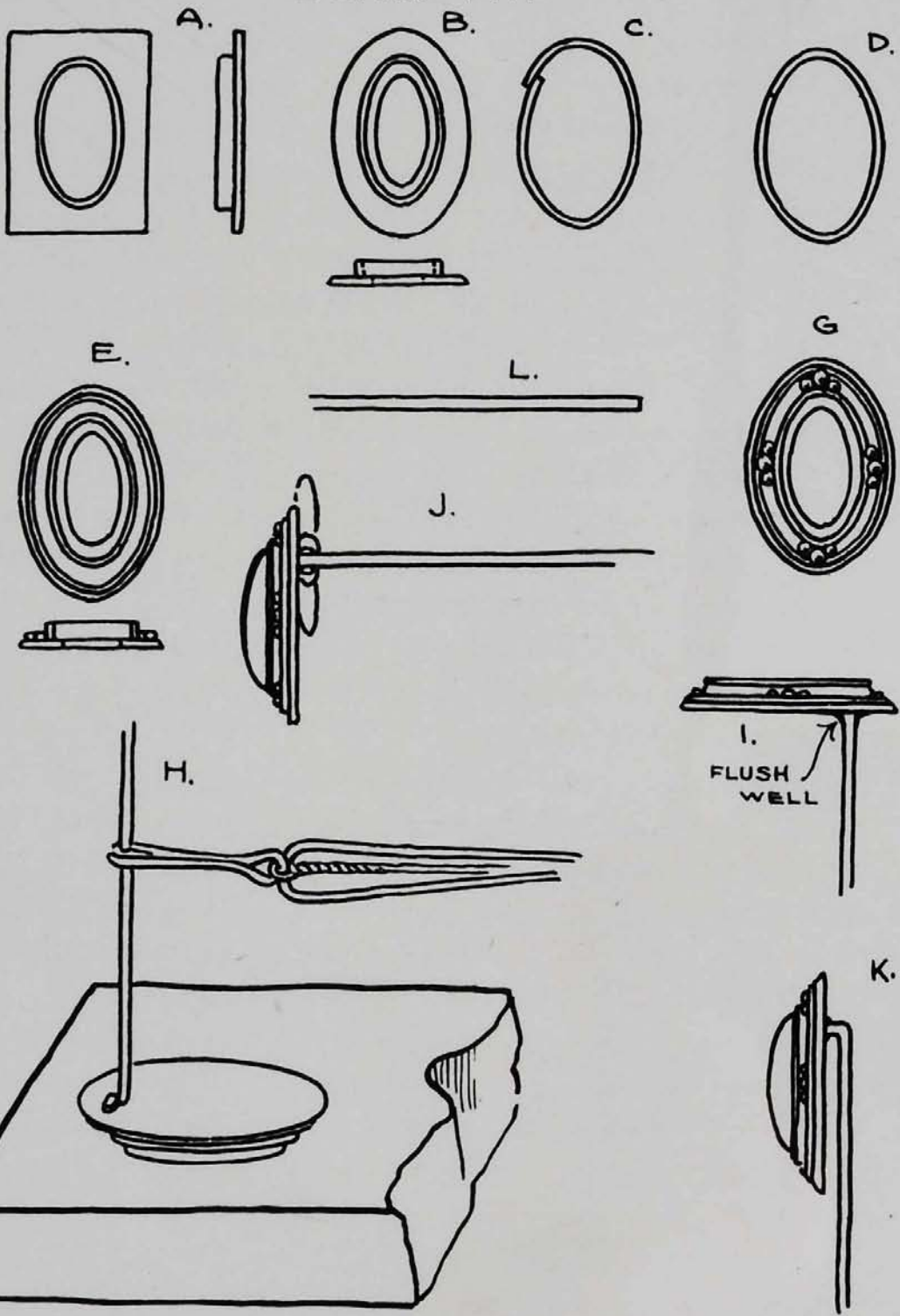


FIGURE 58

PROBLEM 14. Plate XXVI. Make a bezel for the stone and solder it upon a piece of No. 22 gauge flat silver as Fig. A. File to an ellipse to conform to the shape of the bezel, leaving a full $\frac{1}{8}$ in. all around the bezel as Fig. B. Now take a piece of No. 28 gauge round wire and anneal, using a soft flame. If the wire is coiled there is less chance for it to melt when annealing. Straighten out the wire by taking each end in a pair of pliers and giving it a pull. With this wire make an ellipse similar to the shape of the bezel and large enough to leave $3\text{-}32''$ space around the bezel. This wire is not to come flush with the edge of the metal upon which the bezel is soldered. A margin about $1\text{-}32''$ is left in order to make a more interesting design. With an ellipse the correct size we are ready to solder the ends together; to do this allow the ends to pass as Fig. C, then pull them apart and let them butt as at Fig. D. The spring in the wire created by this operation will hold the ends together. A very small piece of solder is placed at the joint and a soft flame is applied. The soldering of the wire must be closely watched or it will burn. Before soldering the wire to the base see that it is elliptical and trued up. This can be done by placing it on a flat surface and tapping it lightly with a wooden mallet or by pressing it between two charcoal blocks with flat surfaces while the wire is red hot. Before soldering the wire to the base, scrape the surface bright. Dip the wire into the borax and place upon the base. Very small pieces of solder should be placed around the inside of the wire at intervals of about $1\text{-}4''$. The student should exercise care here to keep the wire the same distance all the way around the bezel as Fig. E. Do not solder unless the wire is exactly centered. If the work is propped up and a soft flame used good results

SCARF PIN





ought to follow. To encourage the solder to flow evenly, the flame should be kept moving around the base and occasionally applied to the top.



When selecting the shot the student must not use too large ones; if he does they will make it impossible to turn the bezel in setting the stone because the bezel may become soldered to the shot. In soldering a group of shot as those in Fig. G, it is sometimes made easier if a bit of solder is applied on the surface of the metal upon which they are to be soldered, and fused evenly. This gives a surface of solder so that when the shot are put in and the flame applied, the solder once more fuses and the shot are soldered to the surface. When soldering one or two a small piece of solder is placed next to each shot. After all the shot have been soldered, pickle the work, then test each shot to make sure all are soldered. The next step is to solder the stem, for which a piece of No. 18 gauge wire about 2 1-2" long is used. First file end square as at Fig. L, then hold wire in tweezers, and adjust at the place to be soldered as illustrated by Fig. H. About 1-4" from the top of the base is a good place. Enough solder should be used to make a firm joint as Fig. I. Now pickle for the last time. Set the stone in the usual way. The pin is then bent by holding the stem part next to the base in a pair of chain pliers, while the bending is done with the thumb and the index finger of the other hand. When bent it should look like Fig. K.

SCARF PINS

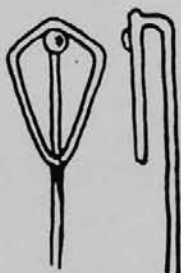
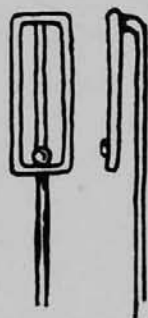




FIGURE 59

PROBLEM 15. Figure 59. This problem is carried out by first making an open back setting as described before. When the bezel is made so that it is a good tight fit, take a piece of No. 19 wire and long enough for the pin plus the distance around the stone, allowing enough for at least three turns around the pin just below the stone. To get this length take a piece of soft iron wire and after carrying it up and around the setting, straighten it out and you will have the required length. Now taper the end that is to make the turn next to the stone for about one inch. It is then bent around the setting making a good fit. Take the smooth flat nose pliers and make the turns around the pin. After the bezel has been carefully placed, it is soldered, making a good flushed joint. The end

of the pin is now pointed and after pickling the stone is set in the usual way.



Chapter XIII

Pendant



PROBLEM 16, FIGURE 60

PROBLEM 16. Figure 60. The first things necessary for this problem are the two stones that form the central feature of the pendant. The ones used in the illustration are pieces of shell pearl. This kind of pearl is inexpensive and looks very well when set in silver. Having the pieces of pearl or whatever we may choose for the central unit, a box setting is made for each piece. In making these settings the bezel is first made for each stone from No. 24 gauge silver 1-8 of an inch wide. After cutting the strip the right width it is bent around each piece of pearl to get the exact size. Mark at the point where it is to be cut, remove the pearl and cut on the mark. We now have the two bezels shown at A and B, Plate XXVII. Bind each of these bezels with the binding wire and solder the joints, C, D. One face of the bezel is next filed level and soldered to a piece of No. 22 gauge silver, E and F, which is to form the back of the

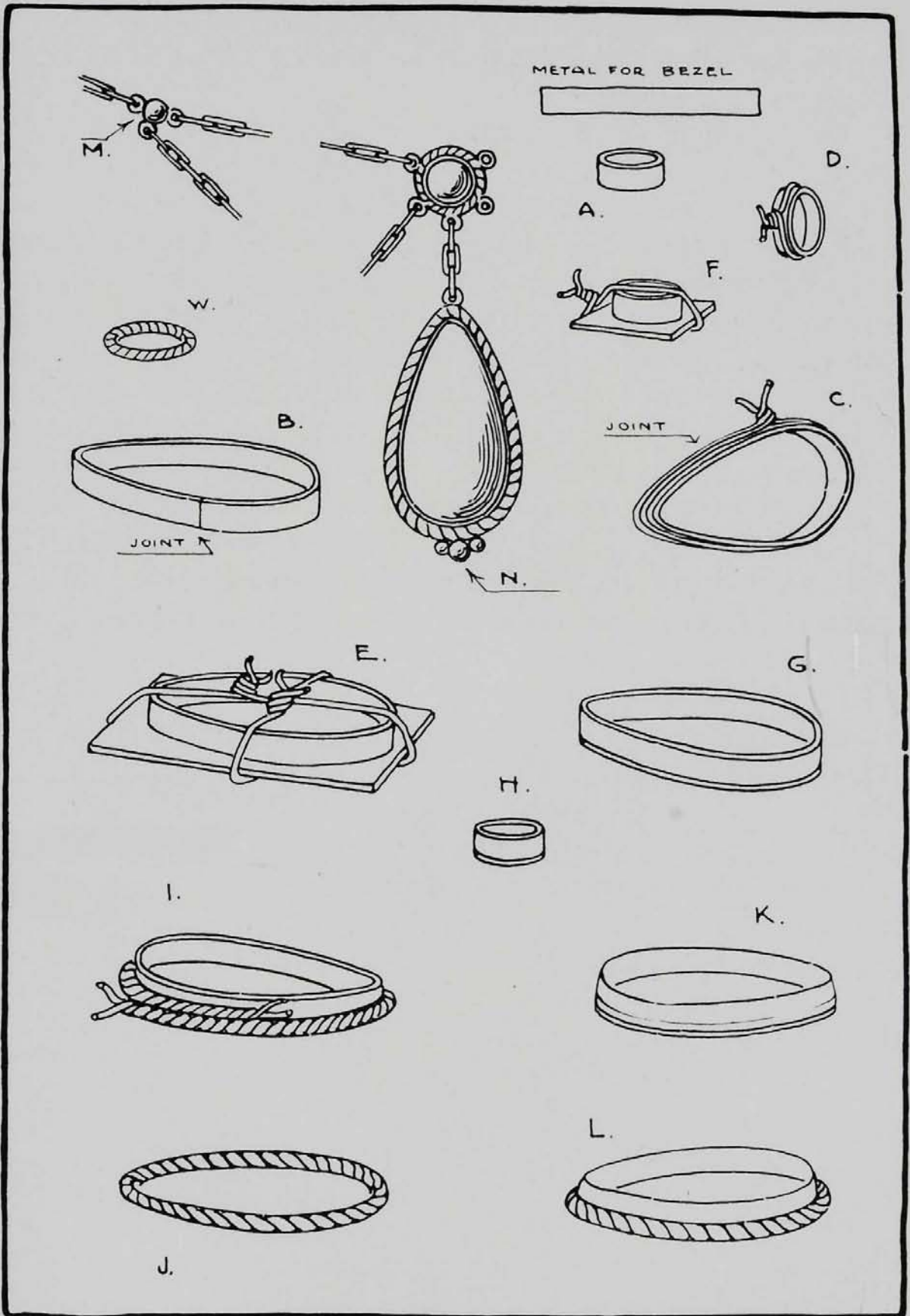




FIGURE 61

against the charcoal block and with two or three turns of the hand the depression is made. Care should be taken to give the depression a smooth surface. Now take a small piece of the scrap silver that was sawed from the edge of the bezel and place it on the charcoal block over the depression; with the blow-pipe, heat the silver to the melting point and it will roll up into the depression and take the shape of a ball. A little experimenting with different sizes of scrap metal will enable one to get just the size wanted. After making the five balls needed we next make the small rings that connect the chain with the bezels and with two of the balls. As there are twelve of these rings needed and as they are the same size, they can all be made at once. Take a small arbor about I-16 of an inch in diameter and fasten one end in the vise together with one end of a piece of No. 24 gauge silver wire. Holding the other end of the wire with a pair of pliers, coil it about the nail or needle until twelve or fifteen turns have been made, Fig. P. Taking it out of the vise and slipping the coil from the nail leaves it in the shape of a small spring, Q. Now with a fine saw the rings are sawed apart. The rings are now as at R. Using the pliers the ends are given a slight twist to bring them in line with each other. The rings are now soldered to the bezels and the balls. Before soldering, however, each ring should be filed a little flat, as at S, where it comes in contact with the

bezel. The filing is done just a little to one side of the joint which has been left unsoldered so that it can be opened to receive the chain when ready to put together. The rings are so small that they should be held with the pliers while the filing is done. When the rings are ready, the bezel is placed on the charcoal block, Fig. T, and the ring put in place. Coat the joint with light borax and place a small piece of solder over the joint. The flame from the blowpipe is next applied and the soldering is completed. The bezel that requires five rings and the balls with three may all be soldered at the same time. If the borax used is too thick it will be difficult to keep the rings in place. The three shot are now soldered in place at the bottom of the large setting. When this is done all parts are pickled.

The stones are set as described in Chap. VI, page 59. The parts are next linked together with the chain. Those who desire can make the chain in the same way that the small rings were made. The shape of the link is determined by the shape of the arbor that the wire is wound on. This arbor may be round, oval, or rectangular, making chains as shown at U. A commercial catch may be used at the back as shown in the illustration or one may be made as shown at V. The chain and settings may be oxidized a little to give them a gray finish which looks well with the pearl.





A

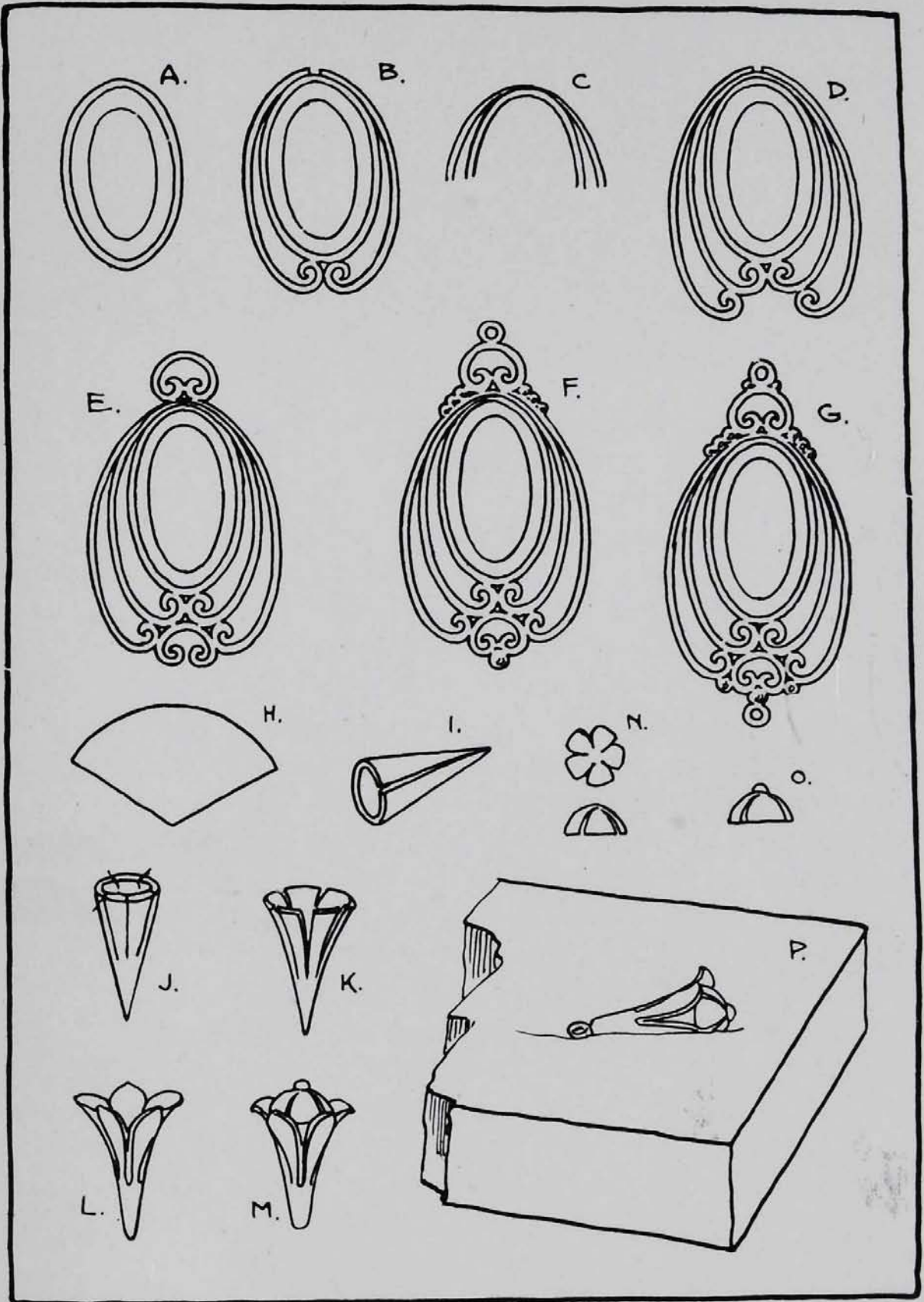
B

C

PROBLEM 17, FIGURE 62

WIRE PENDANT

PROBLEM 17. Fig. 62-A. This pendant is made up of rectangular wire. First make the bezel, solder it to a flat piece about 22 gauge and saw out the back. File the outside flush with the bezel as Fig. A, Plate XXIX. Now make the two scrolls next to the bezel as Fig. B. In making the second scroll from the first, care must be exercised to have them exactly the same size; this can be done by juxtaposition or by making one scroll then straightening it out to determine the exact length required for each scroll. Two pieces of wire are then cut to size and made into scrolls. When they look exactly the same when completed they are soldered next to the bezel. The setting may be held firmly upon the charcoal block by using small pieces of iron wire about one inch long. These are inserted vertically through the opening of the bezel and next to it down into the charcoal. After soldering these two scrolls file them at the top as at Fig. C. Make the two other scrolls in the same way and solder them. Again file the ends of the wires at the top of the pendant as was done in Fig. C. The two small scrolls in Fig. E are made and soldered in the usual way. Before soldering be sure that the lower scroll touches all four of the other scrolls. Next



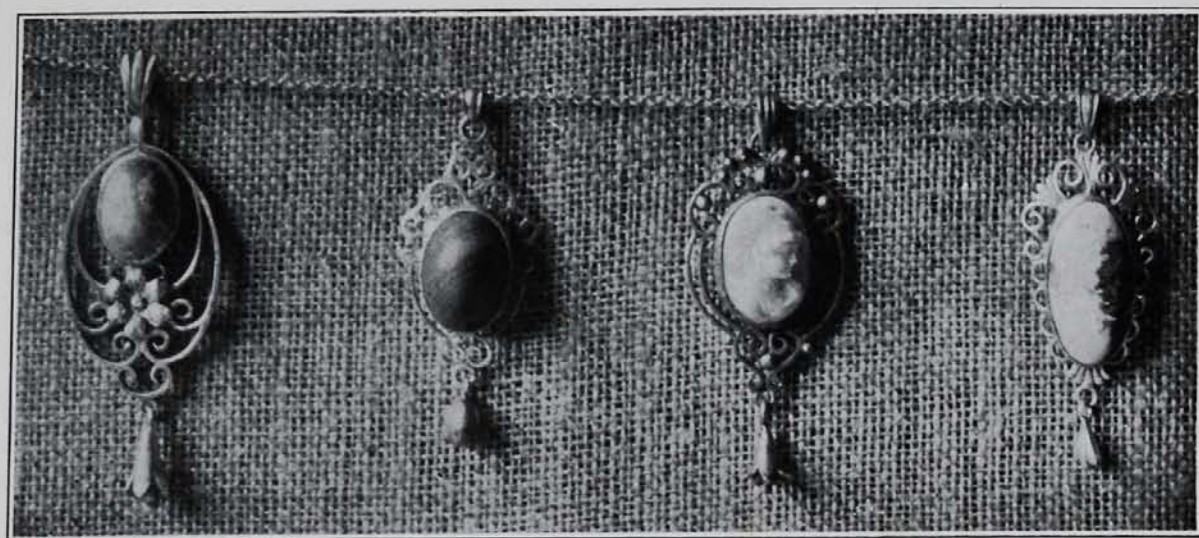


FIGURE 63

solder on the shot and then the link at the top of the pendant as in Fig. F. Solder the two shot and the link at the bottom as in Fig. G. To make the drop, saw out a pattern for a cone of 22 gauge metal as Fig. H. Bring the edges together with pliers as Fig. I. Place the cone over the end of a piece of steel that has been pointed on an emery wheel, and with a steel hammer bring the edges together till they touch. This cone is made exactly as the one for the hat pin described in chapter XI. Solder at the seam using plenty of solder. Stand the cone on the base, place solder on the apex and solder again. The solder should fill the opening at the apex so that when it is filed it will finish to a



FIGURE 64

point. Divide the circumference of the base into five equal parts as in Fig. J, then saw down these points to about one half the depth of the cone as shown by the same figure. Next spread each part with pliers as shown by Fig. K and file them to shape as Fig. L. Make a form large enough to fit into this bell-shaped drop, Fig. N. A small shot is soldered on top as Fig. O. The drop is then imbedded vertically into the charcoal block with the apex down

PENDANTS IN WIRE



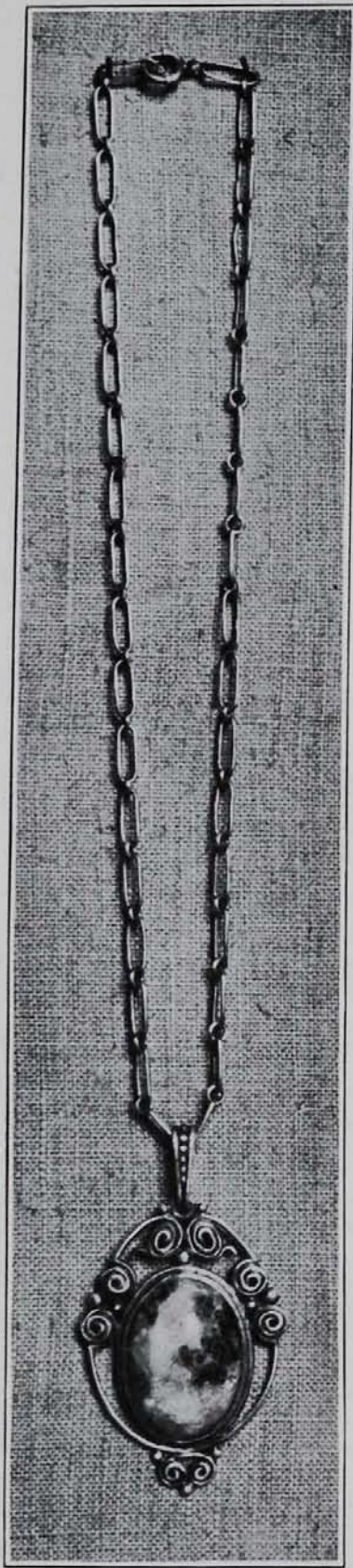


FIGURE 65

and the form soldered in place as Fig. M. The apex is next filed squarely and then slightly rounded. We are now ready to solder on the link. Imbed the drop again into the charcoal block in a horizontal position, and solder the link as shown in this illustration, Fig. P. The link, however, is to be left open so that the open part is not soldered to the drop. The slide is made as described on Page 136, Problem 19, inserted and then soldered. After the drop is attached to the pendant the work is pickled and the stone set in the usual way. The pendant is then finished by polishing and coloring.

PROBLEM 18. Fig. 62-B. In this problem a rectangular wire is used. Either the lower or the upper part of the pendant may be made first. A bezel for the triangular stone is made and soldered to a flat piece of silver, which is then filed close to the bezel as Fig. A, Plate XXXII. The back is sawed out leaving enough metal to support the stone. The back of the bezel is always cut away when transparent stones are used. The outside shape of the pendant is made like the design and to conform to the bezel as Fig. C. The ends at the top are soldered and filed as in Fig. D, then it is soldered to the bezel as in Fig. C. The student should solder each scroll in place as made, as each piece determines the exact size of the next piece. Make the scroll above the stone and solder as in Fig. D; now

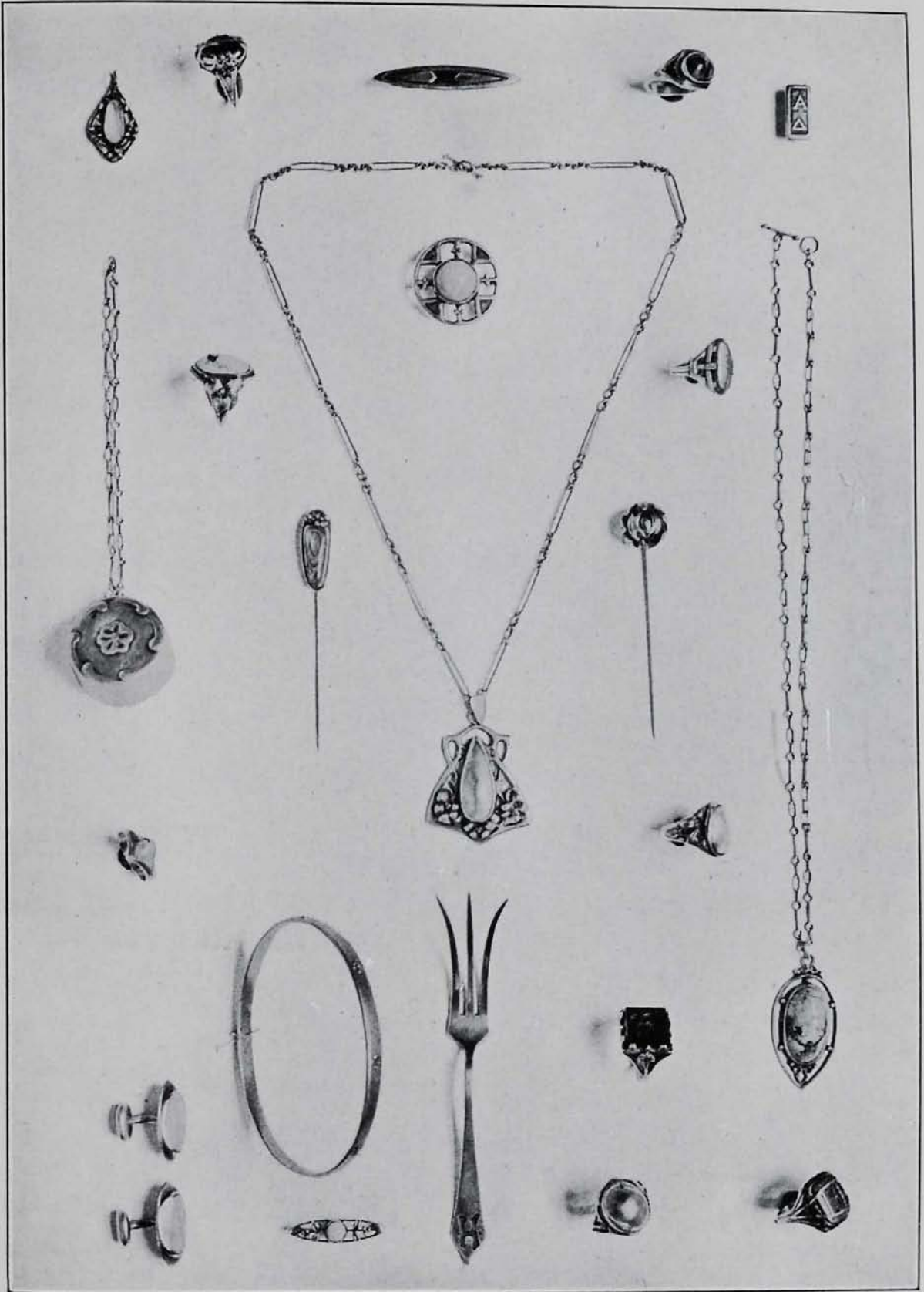


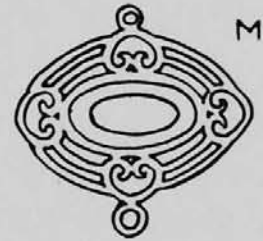
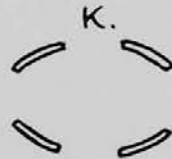
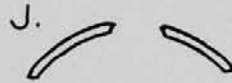
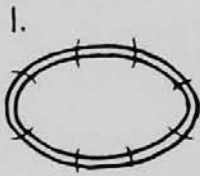
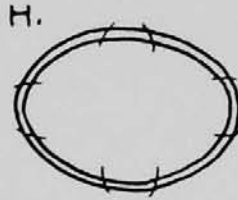
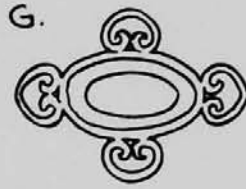
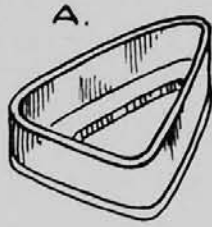


FIGURE 66

proceed to make the two smaller scrolls on either side of the stone by making the larger one first. When the four are made to fit snugly solder all at the same time. The three shot over the first scroll are made separately and soldered in place; the same is done with the others as shown in Fig. F. All the shot and the link at the top in the same figure may be soldered simultaneously if the ability of the student warrants. The pieces of silver for the shot should be cut from wire since it is easier to control the sizes. The experienced worker usually has a small bottle full of shot previously made from which he selects the required sizes. The wire at the bottom of the pendant as marked by N is filed partly away.

Make a bezel for the elliptical stone at the top with an open back. From the same rectangular wire make four scrolls of the same size and solder to the bezel just made as Fig. G. To get them exactly the same size the student should make one, then it should be straightened to get the exact length of the wire used. Four pieces of this length are cut and made into scrolls. If all four cannot be soldered at once at least two should be soldered, one on each side of the bezel, then the other two are soldered in the same way. Next make two ellipses of the same wire as Fig. H and one as large as indicated by the ellipse in Fig. L. Center Fig. G on the ellipse Fig. H and mark by the scrolls. This will determine where they must be cut. Care should be exercised not to make them too short and to keep their

PENDANT.



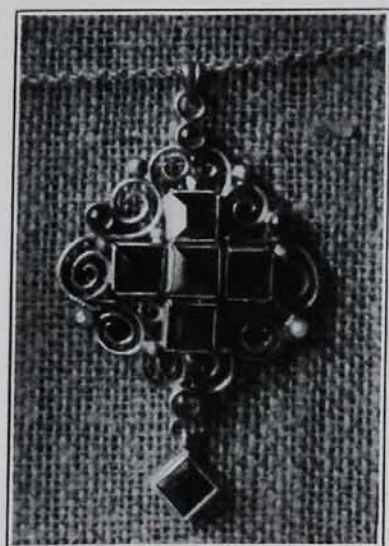


FIGURE 67

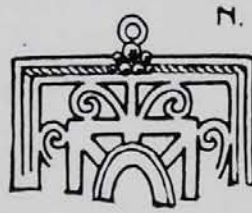
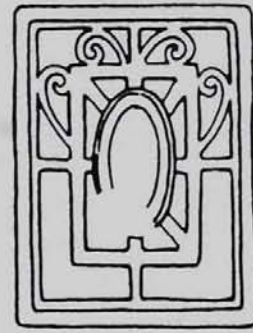
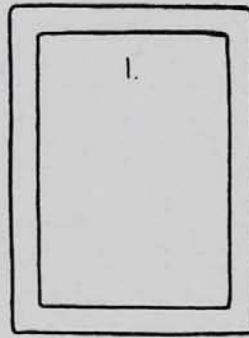
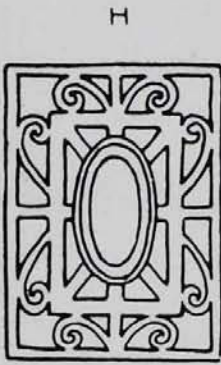
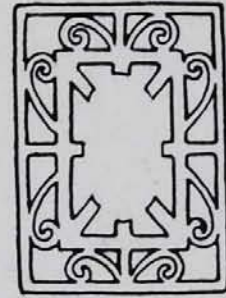
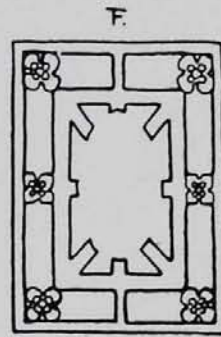
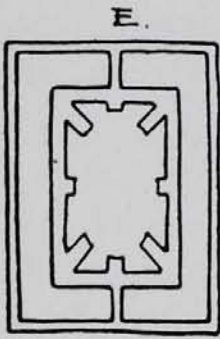
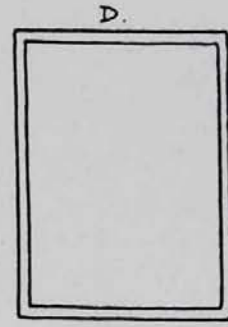
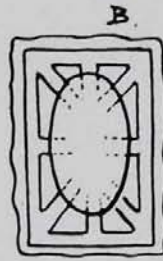
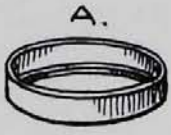
next prepared for setting the stones. When they have been set the two parts are connected with a link made of round wire. The link is closed with the pliers and left unsoldered.

PROBLEM 19. Fig. 68. Choose a stone of about the same proportions as the one in the sketch and make a box setting for it as previously described. Saw out the back, leaving about 1-16" shoulder for the stone to rest on as Fig. A, Plate XXXIII. Now take a piece of 20 gauge flat silver large enough for this problem and draw on the design as at Fig. B. Place the bezel on this metal and mark its position as shown by the ellipse in the same figure. Saw out the design leaving an opening for the bezel just large enough to receive it snugly as Fig. C. Take a piece of rectangular wire and make a rectangle for the outside of the pendant as Fig. D. Connect Figs. C and D by soldering two metal strips between them as at Fig. E. These strips should be made of the same wire as that used for Fig. D. On a piece of 22 gauge flat silver draw the shapes of the flowers. The drawing should be



FIGURE 68

curvature. The same is done with the smaller ellipse I. The first four pieces of Fig. J are soldered in place as at Fig. L, then the smaller pieces in Fig. K. The shot and the link which is made of round wire are then soldered as at Fig. M. The slide is made in the usual way; it is soldered when in place and then the work is pickled. All parts are carefully examined to make sure that the pieces are securely soldered. The bezels are



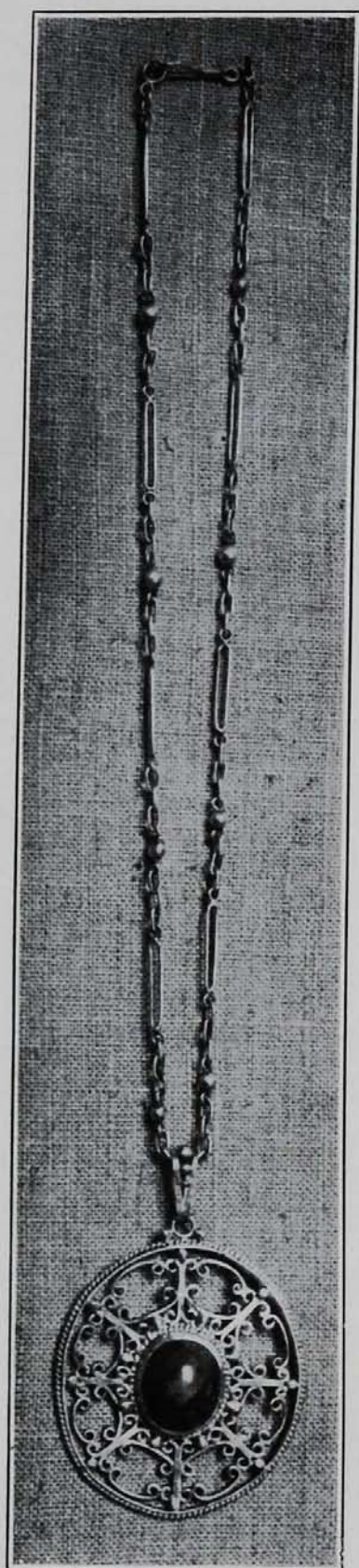


FIGURE 69

made a little larger than the flower is actually required as it is to assume part of a hemispherical form when finished. Saw out the flower as Fig. 70-U. Take a dapping tool of the right size and shape the flowers as Fig. V. The metal may be placed on pitch, lead or hard wood while this is being done. An impression of the general form of the flower may be made first in the lead or whatever is used, then the metal pattern is placed over it. The square flowers represented by Fig. Z are done in the same way. When all the flowers are shaped they are ready to receive the shot. There are five shot in each flower. Make four shot the same size as Fig. W, place a small piece of solder on top and apply the flame. Now place one shot on top of the four and solder again, Fig. X. Do likewise for the others. When the clusters are made pickle them and solder one group in each flower as in Fig. Y and Z-3. The flowers are then adjusted in place as Fig. F, Plate XXXIII, and soldered. With rectangular wire of the same size as used for Fig. D make the scrolls as those in Fig. G. These are soldered in their respective places. The bezel is then inserted and soldered as in Fig. H. Now take a piece of 20 gauge flat silver that is larger on all sides than the part of the pendant already completed. From this piece of 20 gauge metal, make a frame having an

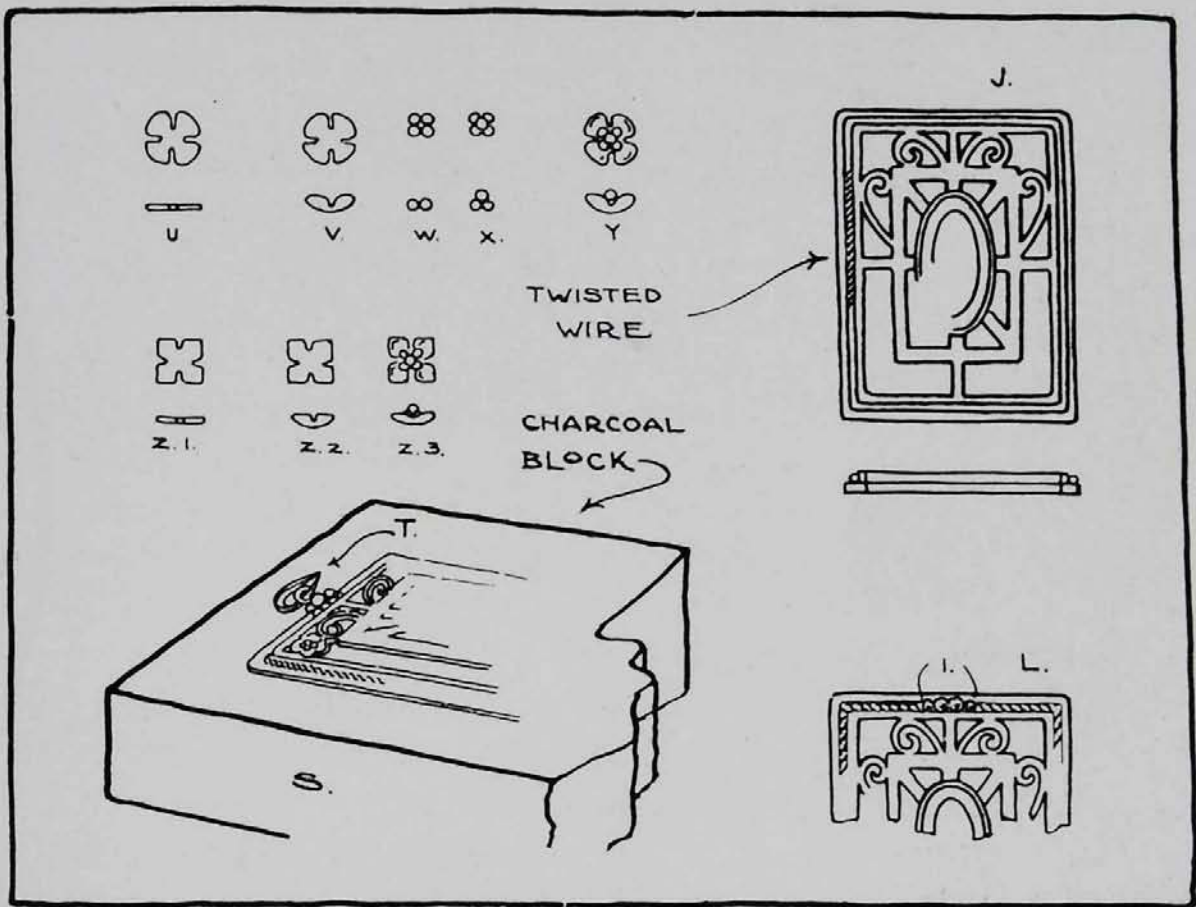


FIGURE 70

opening the size of the inside of the rectangle D as Fig. I. Solder the pendant already made on top of this frame keeping the margin even all around. The two pieces should be bound together with plenty of wire so that the frame may touch the part to be soldered at all points. It is not necessary for the wire to pass completely across the pendant in binding. This will allow a piece of 20 gauge copper a little smaller than the opening of the frame to be placed under the pendant while soldering. The piece of metal if covered lightly with yellow ochre will prevent it from being soldered to other parts. The purpose of this metal is to keep the flowers and bezel from sagging. A rectangle similar to D is made of twisted wire and soldered on the frame as at Fig. 70-J. Part of this wire, at 1, in Fig. L, is removed with a graver to make room for the shot. Four shot are then



FIGURE 71

soldered on the frame as seen in the same figure. The remaining three are soldered next to the frame as at Fig. M, Plate XXXIII, after which the ring for the slide is soldered to the largest of the three shot as Fig. N. The slide through which the chain passes is made of a flat piece of 18 gauge silver. The pattern is first made on the metal as Fig. O. It is next bent as Fig. P either with a pair of pliers or over an arbor. The surface is filed in places as indicated by Fig. Q to relieve the flatness. The slide is passed through the link at the top of the pendant as Fig. 70-s and soldered at T. The pendant is now pickled after which the stone is set.

PROBLEM 20. Fig. 71. For this pendant use a piece of 22 gauge silver 2" x 1½". The design is first made and transferred to the silver on the side that is to be the back of the pendant. After scratching the design on the silver, it is placed upon the pitch block face down and the leaves are slightly shaped or domed with a dapping tool. The whole pendant can be slightly domed, to give it a little more character. The piercing is done after the doming and shaping of the leaves. The finish on the outer edge of this pendant is made of



FIGURE 72

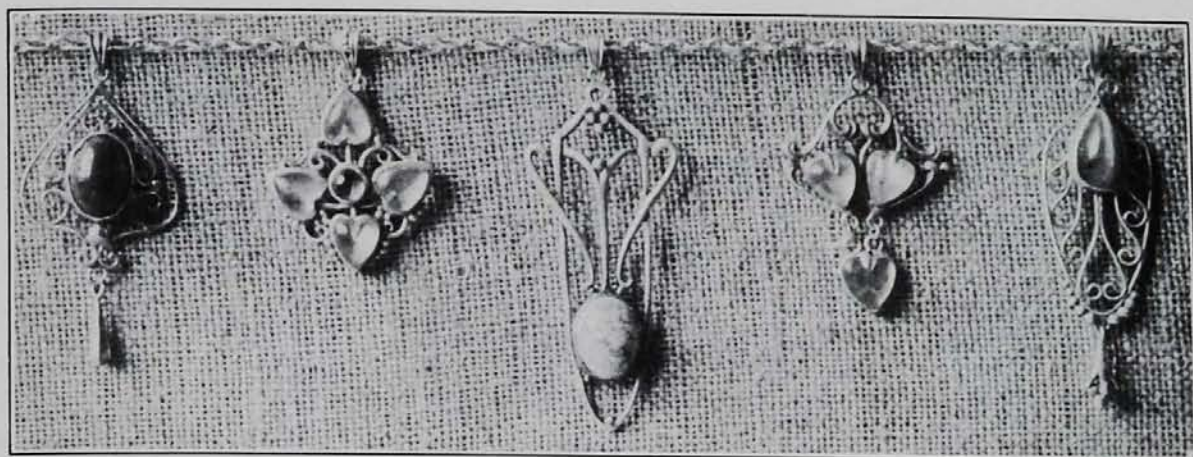


FIGURE 73

twisted wire which gives the appearance of being plaited. A piece of 26 gauge wire is doubled and the ends are placed in the vise and twisted to the right. Another piece is twisted to the left in the same way. The two, when placed side by side and soldered, give a plaited effect. They may be held in place, while being soldered, by coiling fine binding wire around them. The wire is now bent into an ellipse, which should be made small enough to leave a margin on the pierced metal and the ends soldered. It is next soldered on



FIGURE 74

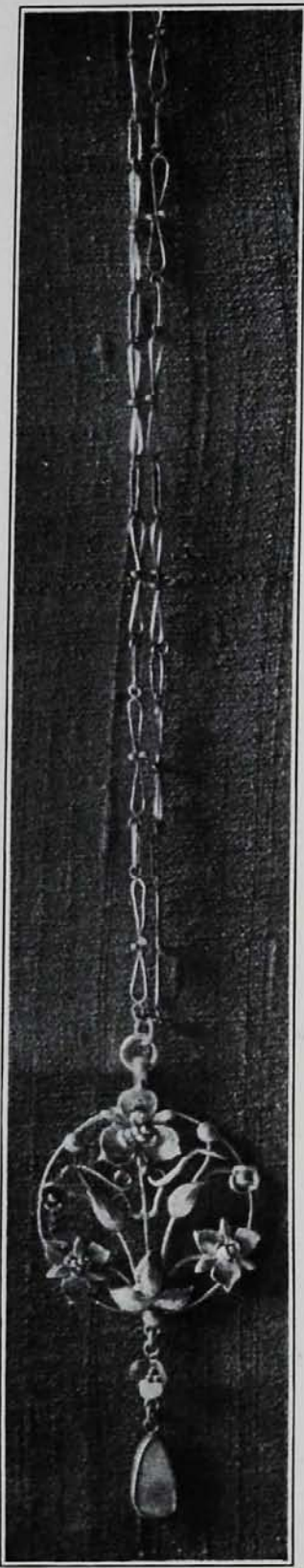


FIG. 75-A



FIG. 75-B

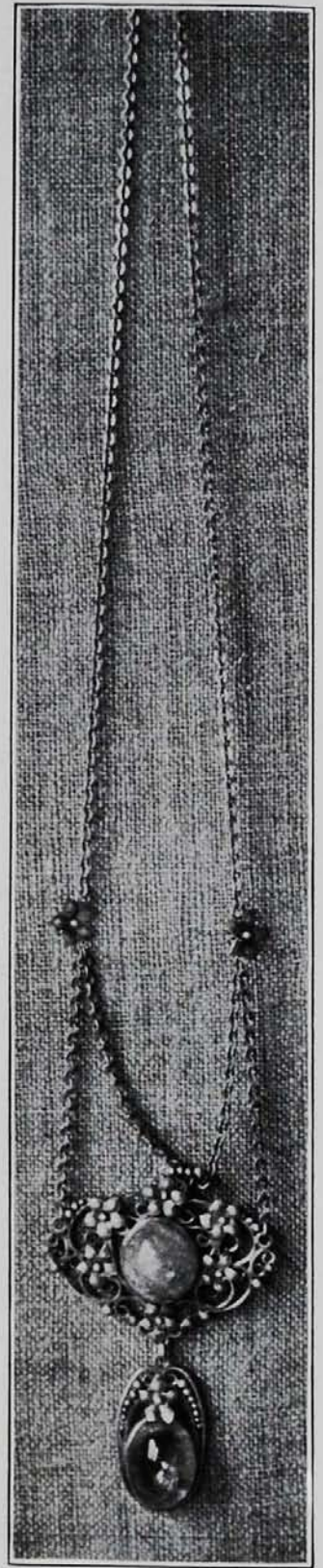
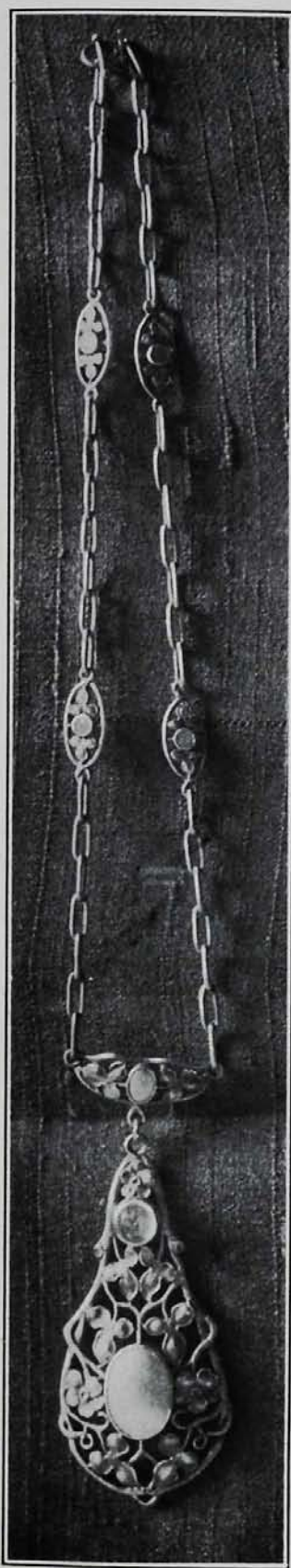


FIG. 75-C

FIGURE 75-B, Designed and made by Josephine Hartwell Shaw

top of the pendant. The solder should be placed at frequent intervals on the inside of the wire. If the wire cannot be made to touch at all points on the flat piece, solder wherever it does touch, then press down on the elevated places when cool and solder again. The shot and ring at the top are soldered as in the previous problem and the slide is made in the usual way.

PROBLEM 21. Fig. 76. No. 20 gauge metal is used for this problem. The design is drawn on or transferred to the metal which is then placed on the pitch block, Fig. 77 and 46. A small chasing or lining tool is used to trace the outline of all the parts of the design. Fig. 46-E. The metal is then taken from the pitch and turned face down. Chasing tools and punches are used here and there to give the desired



PROB. 21, FIGURE 76



FIGURE 77

relief. The metal is again turned over and worked from the face of the pendant. The details of each flower, leaf and stem are brought out with the various chasing tools, although considerable practice will be necessary before satisfactory results are obtained. The saw is used to cut away the background, leaving the parts as shown in Fig. 78. The settings are made to fit the stones and soldered in place. In this problem all of the settings are open back as shown in Fig. 79. This figure also shows the way the leaves and flowers look from the back where they have been dapped up. The various parts of the pendant are linked together with the chain and the stones set.

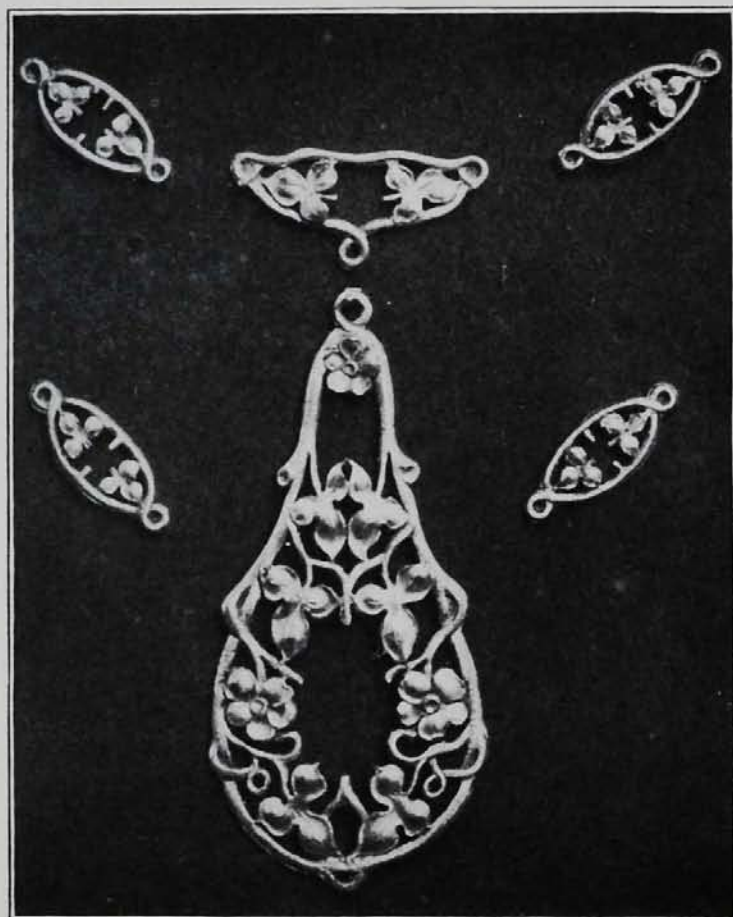


FIGURE 78



FIGURE 79

PIERCED RINGS



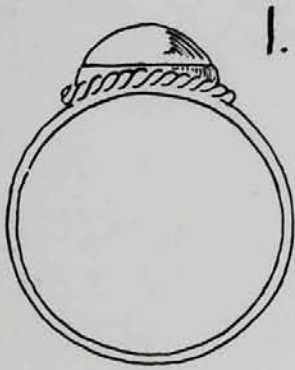
Chapter XIV
Finger Ring

PIERCED RING

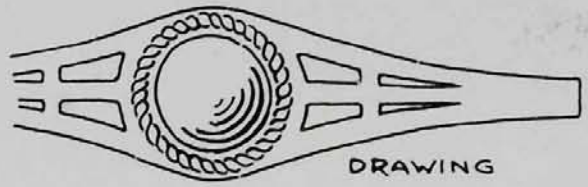
PROBLEM 22. Fig. 80. The size of the ring must first be determined. This is found by using the ring sizes, or by measuring with a narrow strip of paper around the finger on which the ring is to be worn. When this strip of paper is straightened out it will give the length of the metal needed for the ring. Usually a precious or semi-precious stone is made the central feature of the ring. As the size of the stone will determine the width of the ring at the top, it is necessary to know this at the beginning. A variety of methods are used in fastening the stone to the ring, which are called settings. The simplest form, known as a box setting, is employed in the ring here illustrated. Not knowing the length of the metal needed and the size of the stone and the kind of setting to be used, a drawing of the design on Plate XXXIV, Fig. 1, is necessary. Then make a careful tracing, Fig. 2, from the drawing and glue it to the surface of the metal, Fig. 3, A and B. For the ring here illustrated, No. 18 gauge sterling silver is used $2\frac{3}{4}$ " long and $9-16$ " wide. After the glue is thoroughly dry it will hold the tracing firmly in place. A small drill, No. 60, is used to make openings through which the metal saw is placed. For this problem a No. 00 saw is needed as the openings are quite small in places. Saw as closely to the line as possible, being careful not



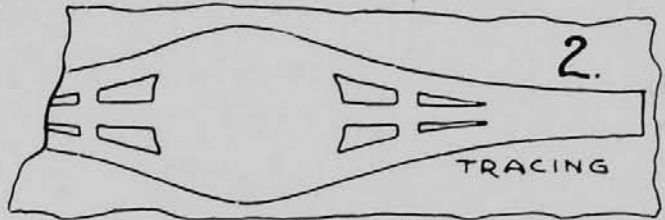
FIGURE 80



1.



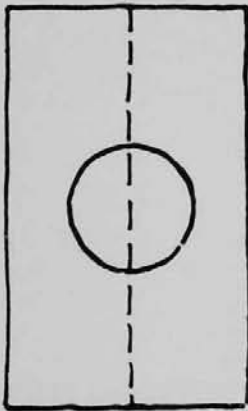
DRAWING



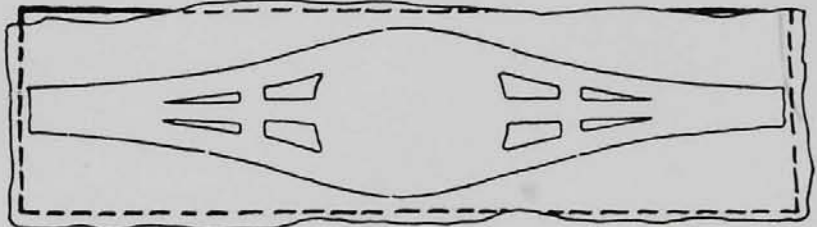
2.

TRACING

5.



3.A. 18 GAUGE METAL

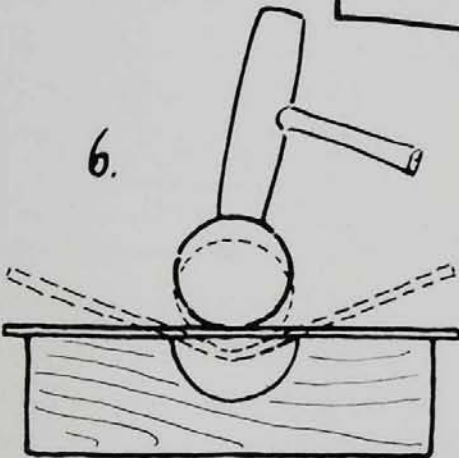


3.B. TRACING GLUED TO METAL

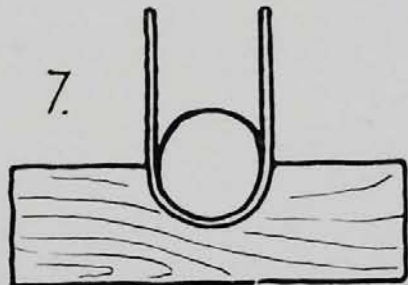


4.

6.



7.



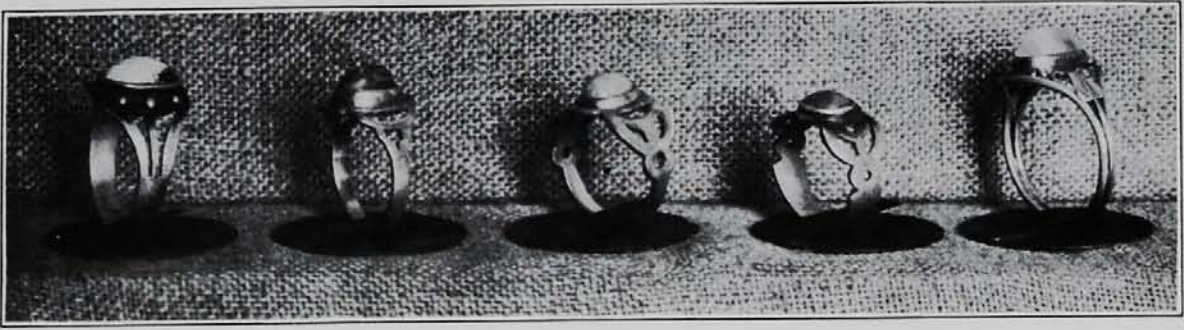
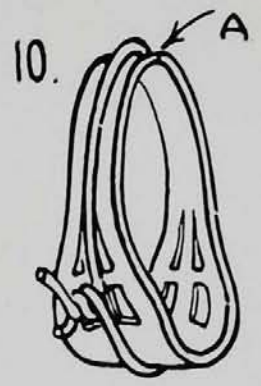
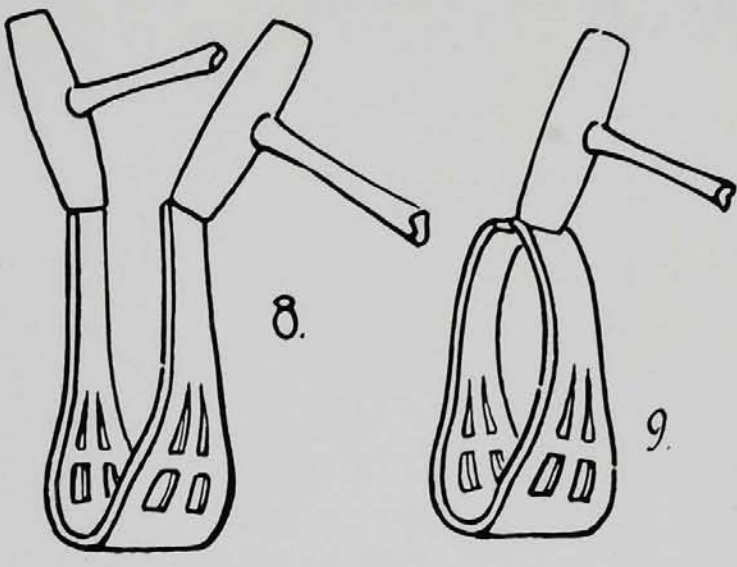


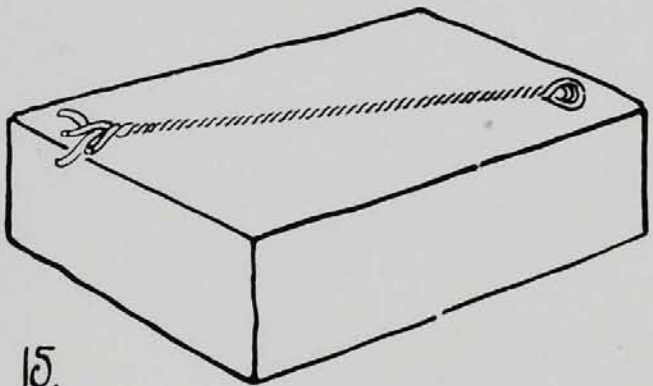
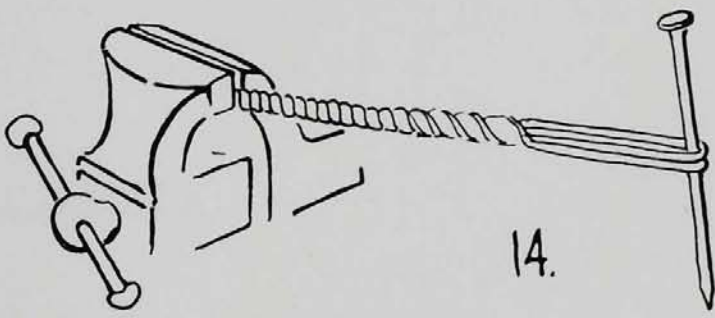
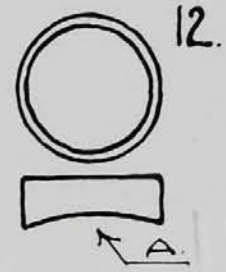
FIGURE 81

to cut into it. After the openings are sawed out, Fig. 4, file them true with the needle files. A square and a knife edge are needed to finish the small openings. Next cut the metal the required length and file the ends square. When the filing is completed and all rough edges are removed it is bent into shape. To do this bore a hole with a $\frac{3}{4}$ " bit into a piece of wood about 2" x 3" x 2" as shown at Fig. 5. Saw through the middle of the block on the dotted line. Take a piece of 5-8" dowell or a ring arbor and having placed the metal over the block as at Fig. 6, strike the upper part of the dowell or arbor with the mallet, driving the metal into the form as at Fig. 7. Then striking on the upturned ends as at Fig. 8, Plate XXXV, first on one side and then on the other, gradually bring them nearer together as at Fig. 9, and continue till they touch. Use a piece of binding wire to hold the ends in contact while they are being soldered, Fig. 10. After coating the joint with borax and applying a small piece of solder at A, place on the charcoal block for soldering.

The bezel is next made from No. 24 gauge silver and for this ring a strip of metal $1\frac{1}{4}$ " x $\frac{1}{4}$ " is needed, Fig. 11. After cutting the strip the right width it is bent to fit the stone, cut the right length, and soldered. As this bezel is to fit a convex surface, some filing is necessary to make a good joint, Fig. 12-A. After fitting the bezel perfectly to the top of the ring, solder in place as at Fig. 13. The twist shown in the design, Fig. 1, is next made. Take a piece of No. 24 gauge



11. METAL FOR BEZEL



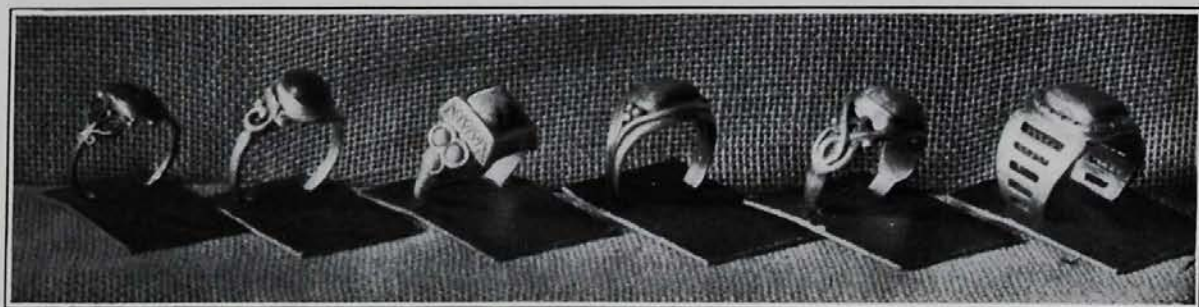


FIGURE 82

silver wire about 12" long, double it twice and place one end in the vise; with a nail or anything that will serve the purpose, twist the wire as shown at Fig. 14. After twisting it from one end to the other, remove it from the vise, coat it with borax and place it on the charcoal block, Fig. 15. Put three or four small pieces of solder at equal distances along the wire and heat to the soldering point, allowing the solder to run along the wire. This is done to hold the different strands together so that they will not separate when cut. When this has been done bend the wire about the bezel to get the required size and then cut and solder the ends together, making a ring as at Fig. 16. A little filing may be necessary at the joint to work the ends together. Now place it over the bezel as shown at Fig. 1, Plate XXXIV, and solder in place. The ring is next pickled to clean off the borax about the soldered joints. The bezel is filed to the right height, the thickness of the edge reduced and the stone set.



WIRE RING

PROBLEM 23. Fig. 83. To make the finger ring in this problem use a circular stone of about $\frac{1}{4}$ " diameter and some No. 14 gauge wire.

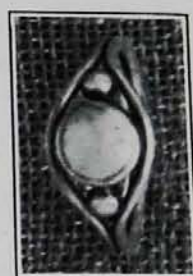
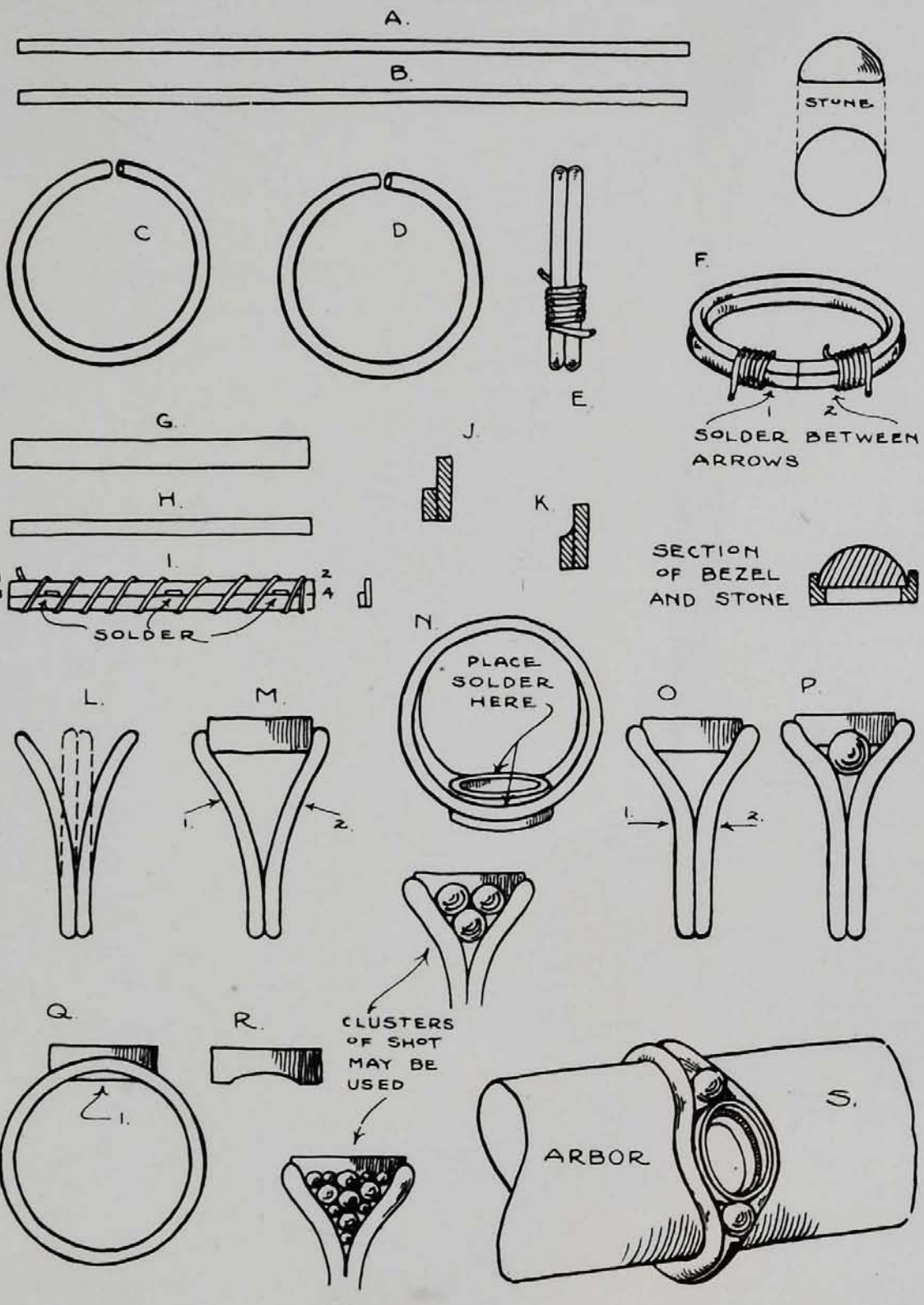


FIGURE 83

First determine the size of the ring as described in Prob. 22. Take two equal lengths of the wire as A, B, Plate XXXVI and bend into circles, as C, D. Next file ends flat and solder. Place these two rings on an arbor and use a rawhide or wooden mallet to make them circular. Care must be taken not to stretch either ring as they should be kept the same size. Next place the rings side by side with soldered joints together as shown at E and bind with wire at places indicated by F. While soldering be careful that the solder does not flow beyond points 1 and 2.

We are now ready to make the bezel. Take a piece of bezel silver No. 24 gauge a little longer than the circumference of the stone and about $\frac{1}{4}$ " wide as at G, also a piece of the same length but $\frac{1}{8}$ " wide as H. Scrape one surface on each piece and file the edges of each strip parallel. Borax the scraped surfaces and place the strip $\frac{1}{8}$ " wide upon the strip $\frac{1}{4}$ " wide with scraped surfaces facing each other, Fig. I. Bind with wire and make sure that edges 1-2, and 3-4 are parallel. Now place small pieces of solder along 3-4 and apply heat from the direction indicated by the arrow in Fig. I to draw the solder under the top strip. Do not use too much solder as it will flush the edge upon which the stone is to rest. The angle ought to be kept a right angle like J and not like that indicated by curve in K. The shoulder bezel is now ready to bend around the stone. The method is the same as in former problems. Care must be exercised not to make the bezel too small as any attempt to stretch the metal will result in a piece of bad workmanship.

WIRE RING



After the bezel is made it is inserted between the rings. The rings are first pulled apart until they can receive the bezel as shown by Fig. L. Do not push the bezel too far down into the rings; that indicated by Fig. M is about right. No binding is necessary as the spring in the rings will hold the bezel in place while being soldered. It will be easier to solder the bezel to the rings if the *whole ring* is inverted upon the charcoal block as shown by Fig. N. The solder is placed at points indicated by arrows; again the utmost care must be exercised not to hold the flame too long while the solder comes to the melting point as the weight of the rings may cause them to fall even with the top of the bezel.



FIGURE 84

Having done this part of the work successfully, we are ready to bring the wire closer together as indicated by arrow at 1 and 2, Fig. M. Here it becomes necessary to use the round-nose pliers for part of the work. As they are apt to mar the surface of the wire it is well to wrap a piece of cloth or thin leather around the nose of the pliers. At first, points 1 and 2 of Fig. M can be brought together part of the way with the fingers. As a last resort the pliers are used till they come as close as shown by Fig. O. Now continue the soldering along the rings as shown by the same figure and also at the points that the rings touch the bezel. Next make some silver shot to fit between rings and bezel, Fig. P. Several shot may be used if desired. The shot should touch in three places; a small piece of solder is placed at each point of contact and then soldered. It is advisable to solder one shot at a time, unless a cluster is used and then they may be soldered together first.

Fig. Q shows that the bezel comes below the wire at 1. This will have to be filed off with the half-round

file till it conforms to the ring as represented by Fig. R. The ring is now ready to be cleaned and pickled. The stone is set in the usual way except that the work can be accomplished more easily if the ring is placed over an arbor as shown by Fig. S. After the stone is set the ring is polished and oxidized if desired.

FLAT RING WITH LEAVES APPLIED

PROBLEM 24. Plate XXXVII. To make the ring as illustrated here take a piece of 20 gauge metal and mark out the pattern in the usual way. Next file to the drawing as Fig. A and bend as shown in the previous problem on the ring. When it has been shaped and soldered at the joint as Fig. B, make the bezel. The bezel should be made high enough to allow for filing as Fig. C. It is then filed as Fig. D to conform to the shape of the ring and then soldered as Fig. E. In this ring the two wires 1,2, in Fig. F along the surface of the shank are 28 gauge. Two separate rings are made the size of the largest diameter of the ring as Fig. G and bent as in Fig. H, to conform to the contour of the shank. They are adjusted in place as in Fig. F and soldered all around. If these rings are made to fit tightly it will require no binding. The leaves are made of 24 gauge silver; the drawing is first made on the metal and then it is sawed as Fig. I. They are then dapped up in a lead block. The leaf is placed so that the drawing of the mid-rib is next to the lead. After it is slightly domed as Fig. J, file the surface along the lines delineating the mid-rib as Fig. K. The metal may also be removed with a graver. Having made the mid-rib on all the leaves they are adjusted to the surface of the ring by bending with pliers or flattening where needed. Care should be taken that they touch the surface of the ring at all points. Next place two leaves on one side of the ring as in Fig. L and apply small pieces of solder around the leaves. See that they are soldered at all points. Having done the same with the

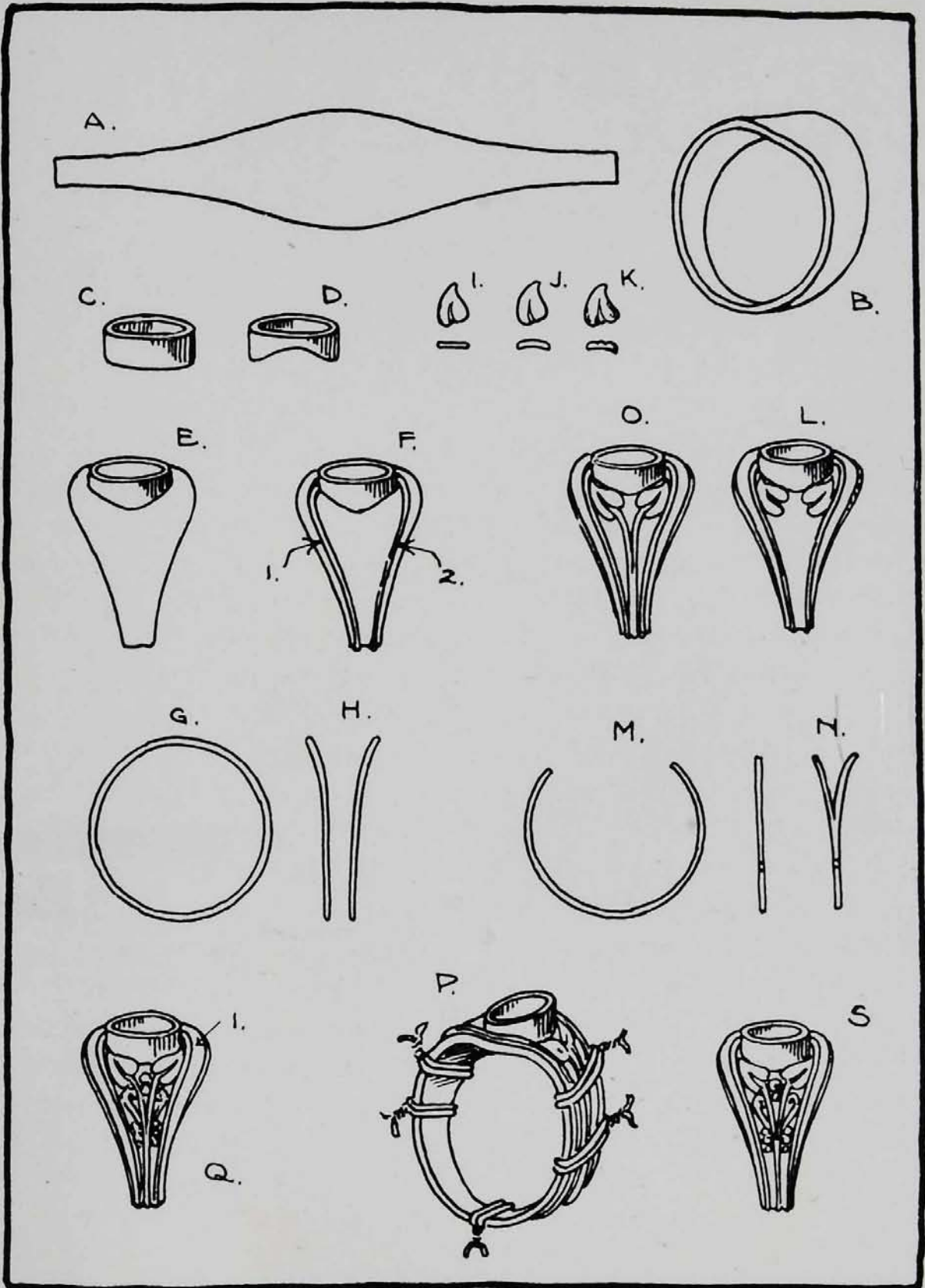




FIGURE 85

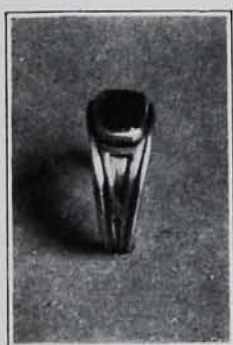
other side we are ready to make the stems. Take a piece of square wire about the same size as the round wire used for the rings in Fig. G, and make a ring of the same diameter. Cut out a piece of this ring as in Fig. M so that the wire when applied to the ring will reach from the leaves on one side to those on the other side. Slit the wire at each end and spread as in Fig. N. Apply this wire as Fig. O and bind as Fig. P. The smaller pieces of wire and shot may now be made to fit. All the pieces on one side should be soldered at the same time. When the other side is completed the ring is pickled and the small pieces just soldered are tested separately to make sure they are securely soldered. The margin at I-Q is next filed narrower and to a slight chamfer as in Fig. S. The bezel is then filed to the proper height to receive the stone. In setting the stone the ring may be held in a ring clamp or placed over an arbor to help keep its shape. When the stone is set it is finished by filing and polishing respectively.



FIGURE 86

THE CARVED RING

PROBLEM 25. Figure 86. When the design is to be carried out by carving as in this problem, the blank ring must first be made and filed into shape as desired. The design is sketched on the



blank and held in the ring clamp as shown in Fig. 87. A variety of engraving tools, both round and flat, are needed for the carving. The cutting is a slow process and the tools have to be handled with complete control to avoid slipping. After the cutting is carried to the desired point, small needle files of assorted shapes are used to smooth up the work. Sometimes the ring is put on an arbor and the lines are more clearly defined here and there by the use of a chasing tool. The background may be matted in the same way if desired.



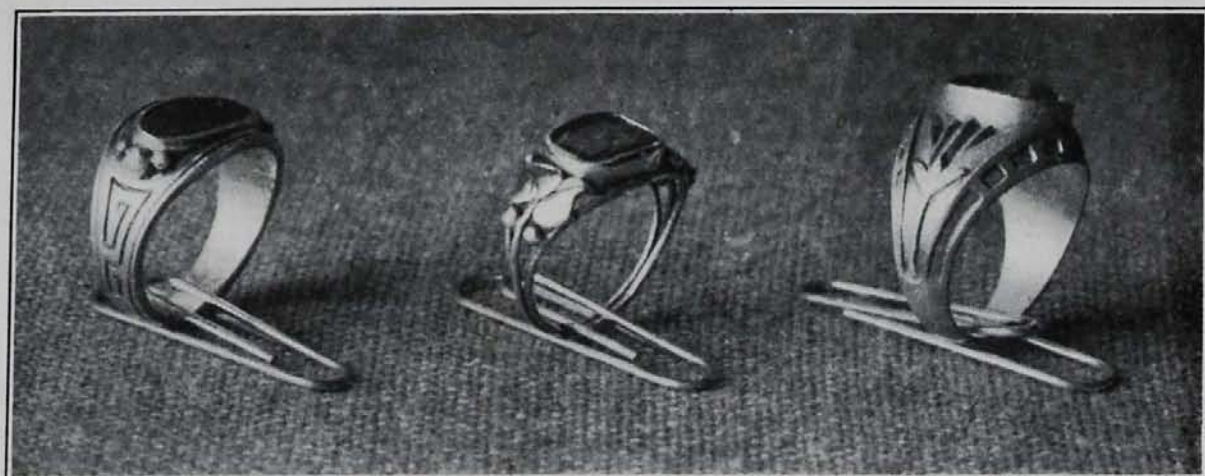


FIGURE 86-A

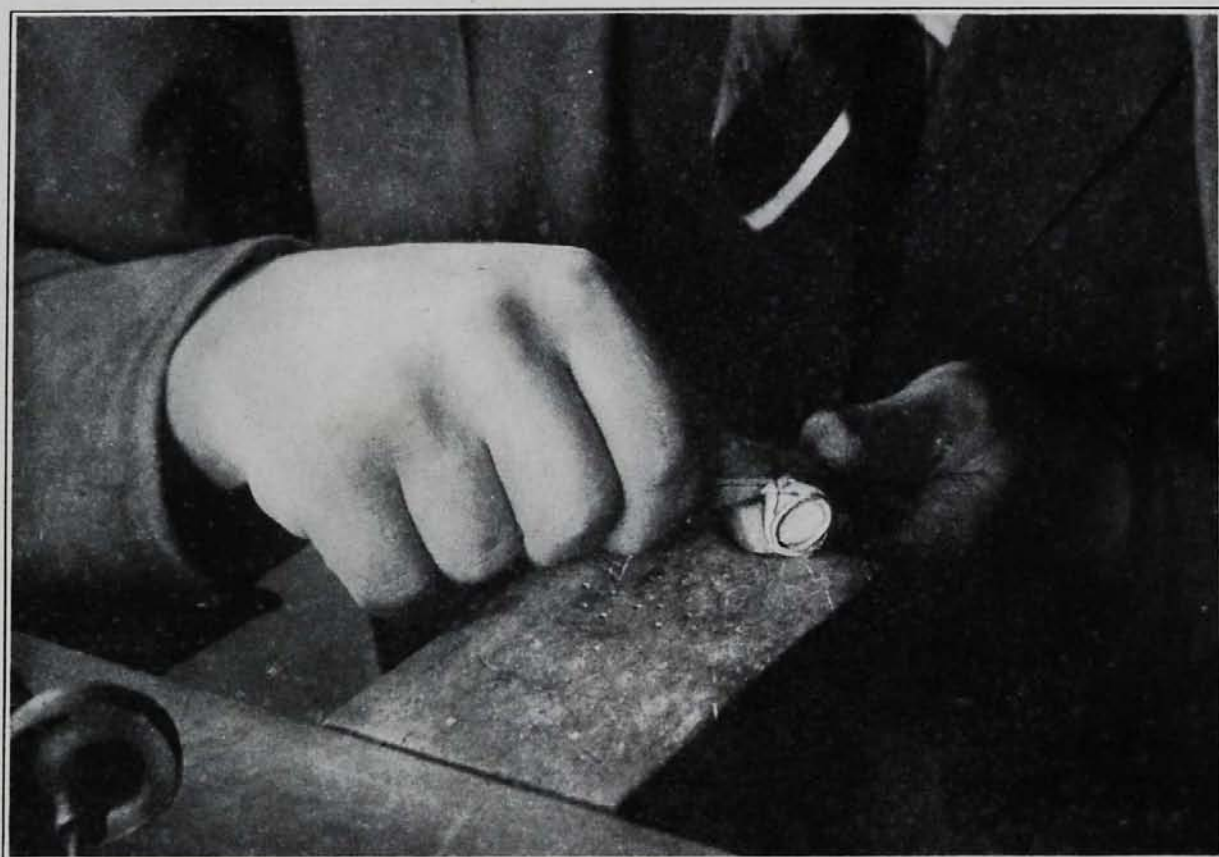


FIGURE 87

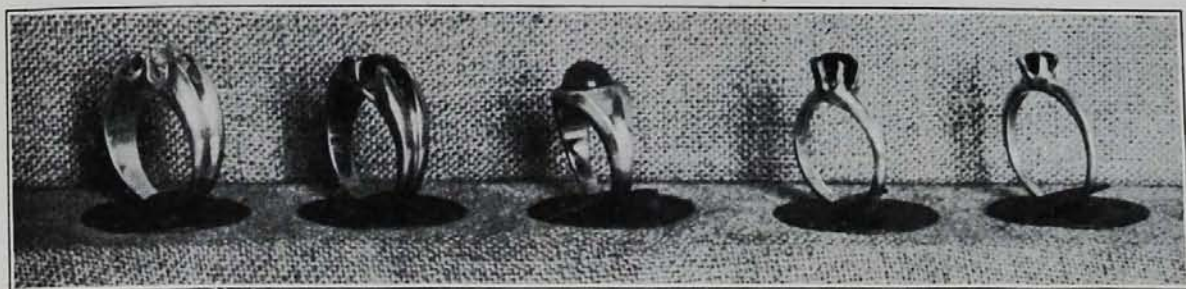


FIGURE 88

THE BELCHER SETTING

PROBLEM 26. Figure 89. To make this setting a ring is first made of metal thick enough to take the depth of the stone to be used Fig. 90A. After filing the blank into shape use the center punch to start a hole for the drill. This hole should be on the top of the ring and in the center. The size of the drill used is determined by the size of the stone. The hole should be smaller than the diameter of the stone. A small round file is used to file the metal away in making the prongs. The six prongs or points in this setting require careful filing to have each one equal in size as well as to have the openings uniform. When most of the filing has been done a burr which is similar to a drill, Fig. 90D, is used to make a seat for the stone. These burrs are made in various sizes, Fig. 91A, so that one may be selected having the right diameter for the stone. After the



FIGURE 89

When most of the filing has been done a burr which is similar to a drill, Fig. 90D, is used to make a seat for the stone. These burrs are made in various sizes, Fig. 91A, so that one may be selected having the right diameter for the stone. After the

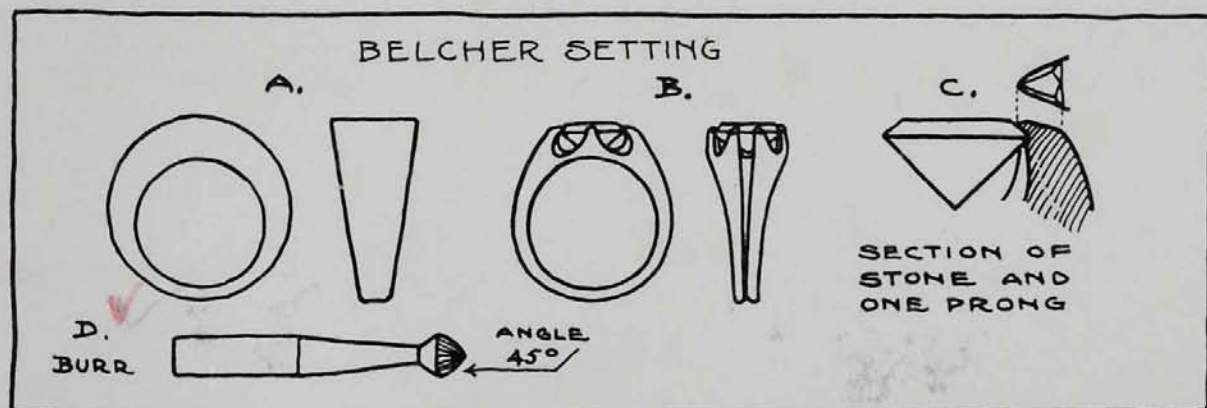


FIGURE 90



FIGURE 91A

seat has been made the file is again used to remove more of the metal and to shape the ring as desired, Fig. 90B, while the ring is held in the ring clamp the stone is placed in position, Fig. 92, to see if it fits. If it does not fit exactly so that the edge of the stone bears evenly all around the seat, a little of the metal may be removed with the graver where

necessary, Fig. 91. The stone is again put in position and when it rests so that it is level, Fig. 93, it is ready to set. During the fitting process the stone is held with a small piece of wax. The setting tool is now taken and held as shown in Fig. 94 and each of the



FIGURE 91. Cutting the seat
[156]



FIGURE 92. Trying the stone



FIGURE 93. Seeing that the stone is level

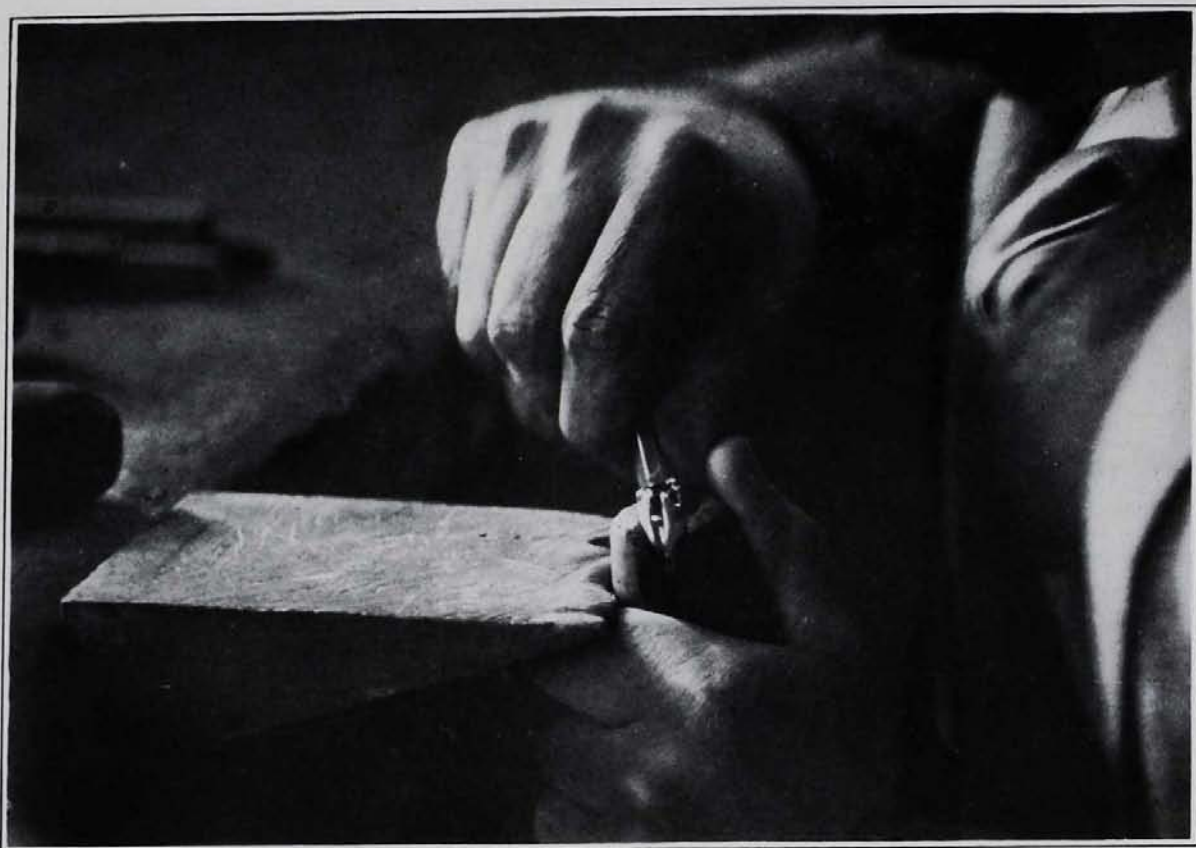


FIGURE 94. Setting the stone. First step



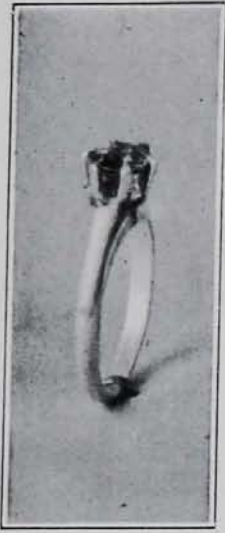
FIGURE 95. Setting the stone. Second step



FIGURE 96. Filing the top of prongs



FIGURE 97. Bright cutting top and sides of prongs



prongs is pushed gradually over the stone. After pushing the first prong the one opposite should be pushed next and so on with each of the other prongs. When the prongs have been forced part way over the stone the file is used to remove a little of the metal at the top of the prong so as to make it easier to force the point of the prong completely over. Holding the setting tool in a more perpendicular position, Fig. 95, the points are pushed over until the stone is held firmly in place. The file, Fig. 96, is again used to shape the top of the prongs and then the flat graver, Fig. 97, is used to cut the point as shown at C, Fig. 90. This is called bright cutting and completes the setting.

THE TIFFANY SETTING

PROBLEM 27. Figure 98. The Tiffany or prong setting is used mostly for setting diamonds or other transparent stones. A conical tube is first made of No. 18 gauge metal, Fig. 99A. The height and diameter of this tube is determined by the height and diameter of the stone. The shank of the ring is made and the tube soldered in place, Fig. C. The file is used to make the prongs, Figs. B and D. The ring is imbedded in the shellac with only the setting exposed.

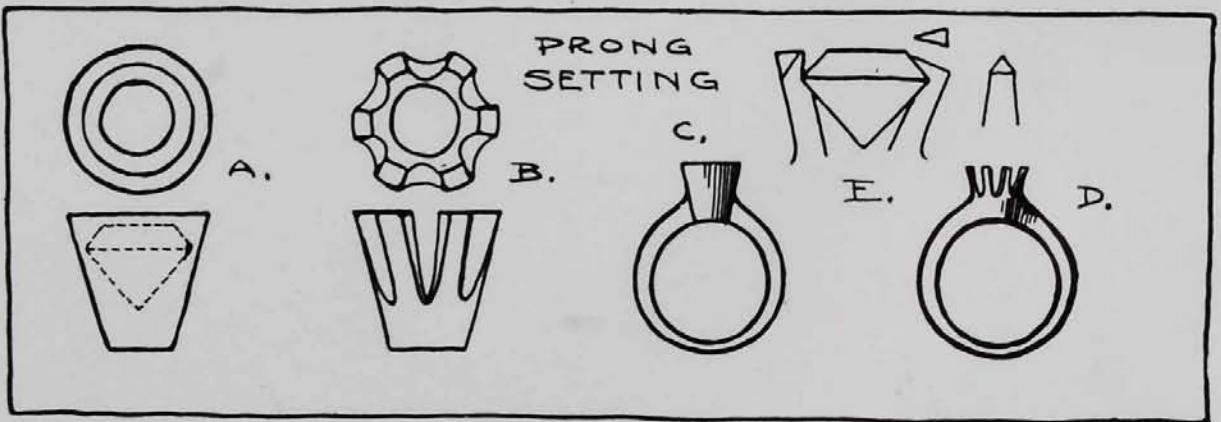


FIGURE 99

Then with the engraving tool the bearing or shoulder for the stone to rest on is cut, Fig. E. The prongs are all adjusted with a pair of pliers so that the stone will fit tight. The stone is pressed down firmly until the edge rests evenly on the bearing of each prong. This leaves the ends of the prongs sticking up above the edge of the stone. The next step is to push all these ends firmly over the edge of the stone, Fig. E. When the prongs are all in their places they are trimmed to a point with the engraving tool. This is usually done by making a cut on either side of the point and one on the top and is termed bright cutting.

THE GYPSY SETTING

PROBLEM 28. The Gypsy ring, Fig. 100, is made by taking a piece of heavy metal long enough to make the required size and as thick as the stone to be used is deep. Lay out on the blank, Fig. 101A, the long and short diameter and scratch lightly on the metal. Then with the saw and file shape the blank as shown at Fig. B. After this is carefully shaped so that it is symmetrical, it is placed over the lead block, Fig. C, and with the ring arbor it is turned up and the ends brought together for soldering. A generous piece of solder is wedged in between the ends, Fig. D, and if carefully fitted when soldered, the ends will spring together and show very little of the solder. After the joint is soldered the half round file is used to remove surplus solder on the side of the ring, Fig. E. It is then placed over the arbor and while it is held over the lead block it is shaped up with either a lead or a rawhide mallet.

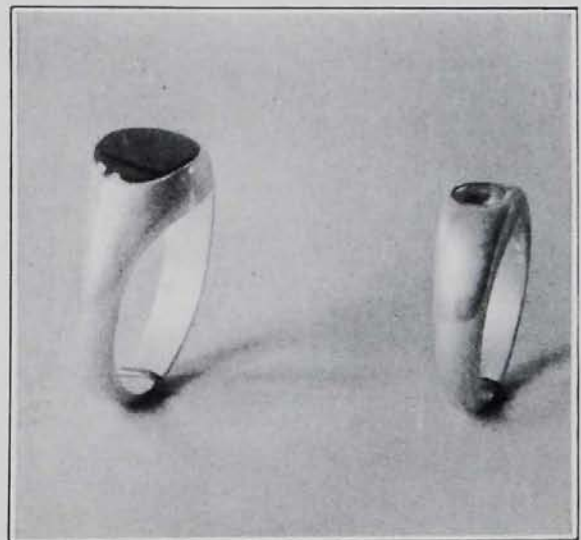


FIGURE 100

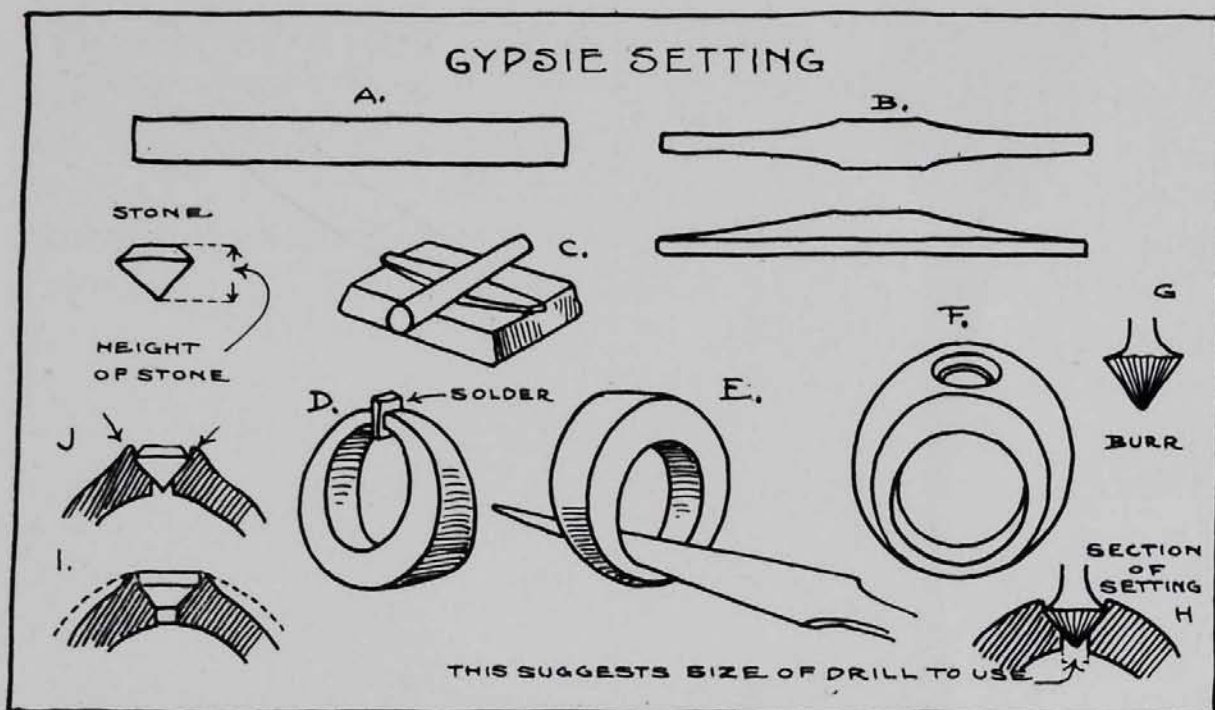


FIGURE 101

Now take the file and true up the edges on the outside, being careful to retain the lines that were scratched on the blank at the beginning. After it is filed so that it is symmetrical on either side of the long and short diameter of the block, it is placed over the arbor and a small depression is made at the intersection of these two lines using the center punch. This depression is a beginning for the drill which is used to make the hole at the top of the ring. The ring is held in a clamp during the drilling or

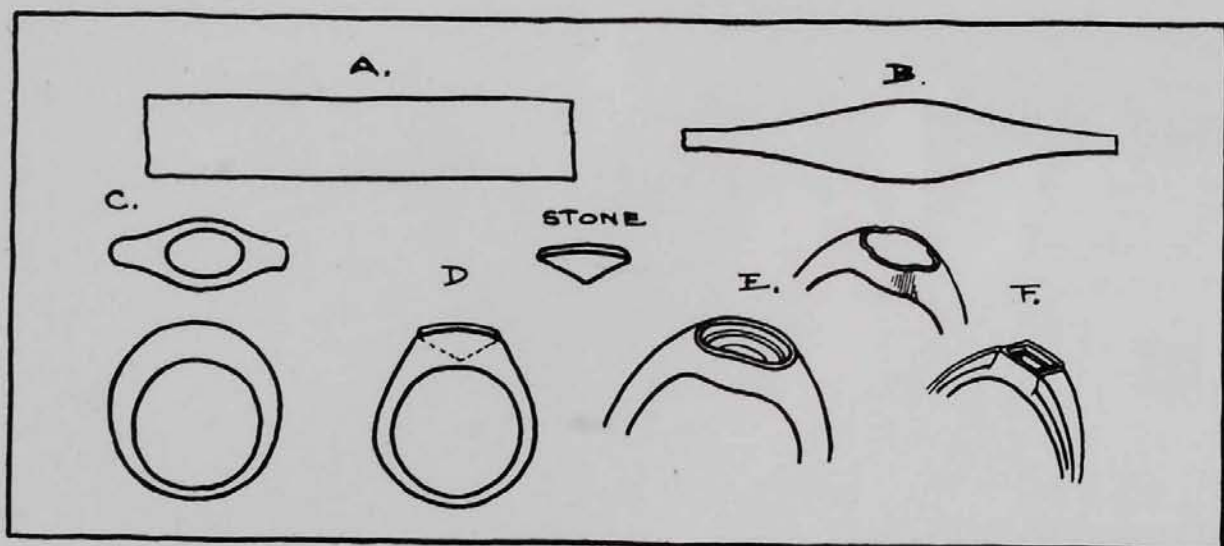


FIGURE 102



FIGURE 103

it may be held in a vise and done with a hand drill. The size of the drill should be determined by the size of the stone, and should be much smaller than the greatest diameter of the stone, Fig. H. After this hole has been made the next step is to take a burr, Fig. G, and ream out the hole to the size of the stone. If the burr is allowed to sink a little below the surface of the top, it will form a seat or shoulder for the stone to rest on, Fig. F. Up to this time the ring has been flat with square corners, but it is now time to file it into the desired shape by rounding the corners and removing some of the metal at the top next to the setting, Fig. I. After the ring has been filed into shape and the file marks removed, using fine emery paper, it is ready for the stone.

In setting the stone the ring is held in the ring clamp, Fig. 103. At first we must be sure that there is a level shoulder or seat for the stone to rest on. The metal may be removed here and there as needed with

the engraving tool, and when everything is ready the stone is dropped in place. The pusher as described in Chapter V is used to force the metal over to the stone, Fig. 101 I. This is done a little at first at four points and then after more of the metal has been removed with the file the pusher is used again, and these operations are repeated until the metal has been completely pushed over and the stone held firmly in place. A little more filing is necessary to finish the setting and after using the graver to finish the edge next to the stone the setting is completed. It is then polished and finished as desired.

Fig. 102 is worked much the same as Problem 28 except that the stone is cut to conform with the outline of the ring. In this ring the stone is oval in shape which requires a little different handling than with the circular one. A hole is drilled the required size as before, and then it is necessary to file the opening to fit the stone. The shoulder or seat must be cut entirely with the graver in this case, and as the stone is cut on the arc of a circle it makes the setting more difficult. The stone is set in the same way as in Problem 28.



Cuff Links and Cuff Buttons

PROBLEM 29. The cuff link and cuff button is usually made up of three pieces, the button, stem and bean.

The button, if circular, is about 11-16" in diameter and if elliptical about $\frac{1}{2}$ " x $\frac{3}{4}$ "; the bean may be spherical, hemispherical or bean shaped as Fig. 105-G. If spherical or hemispherical it may be 5-16" diameter and if bean or lentil in shape it may be 5-16" x 7-16". The stem is usually a piece of round wire about $\frac{3}{4}$ " long and No. 8 gauge. The button which is the only part that gives chance for decoration may be worked out with a pierced, chased, etched, applied, or enameled design. If an enameled or etched design is chosen, the stock should be heavy; about 12 gauge. If a chased design is desired a piece of 24 gauge metal is suitable as Fig. A. This thin piece is afterward domed as Fig. B, the design executed, then soldered to a flat piece of 20 gauge as Fig. C. In all cases it is well to have the button slightly domed when finished. The superfluous metal is then sawed away as Fig. D. Assuming now that the button is complete, the next step is to make the bean. This can be made of 20 gauge metal in the shape of a sphere or hemisphere.

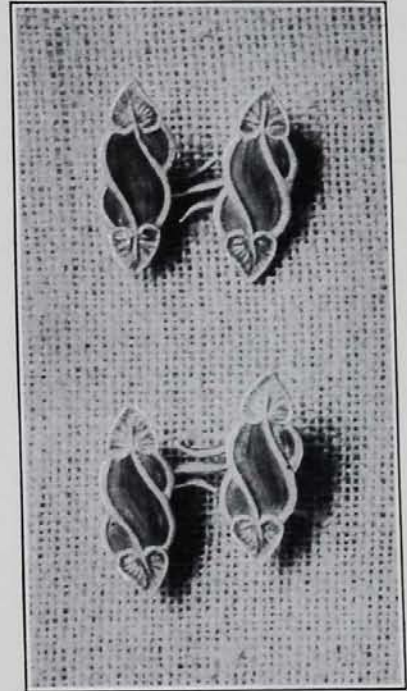


FIGURE 104

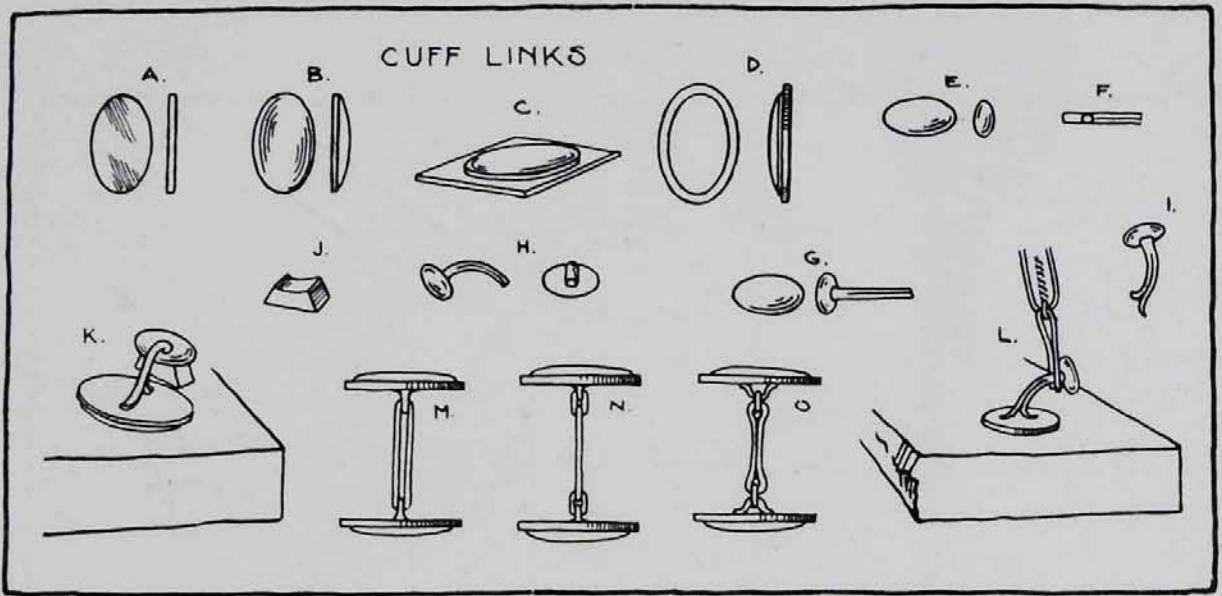


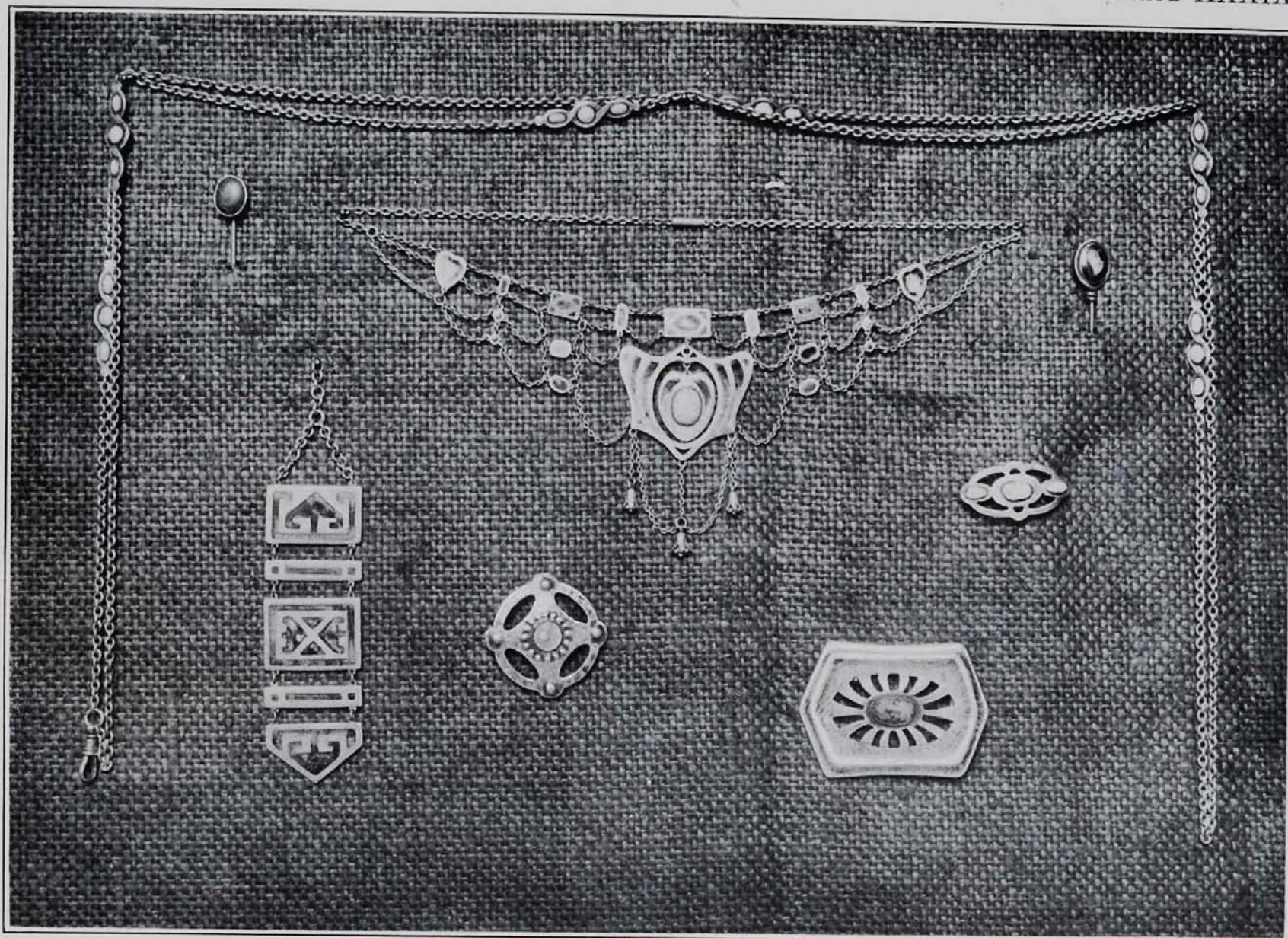
FIGURE 105

The stem can be made of No. 8 gauge round wire. Take a piece about $\frac{3}{4}$ " long and slit it longitudinally about $\frac{3}{4}$ its length as Fig. F using a very fine saw blade. The stem is now ready to be soldered to the bean, but before doing the soldering it is necessary to make a small drill hole on the bean next to the place where the stem is to be soldered, to avoid combustion when soldering. A strong union of the two pieces as Fig. G should be secured by using plenty of solder. The stem is then curved with pliers or over an arbor with a mallet as Fig. H. The ends of the stem are then spread and shaped as in Fig. I. The stem and bean can be soldered to the button by holding them with tweezers as at Fig. L or by making a metal support as Fig. J to hold the bean in place as Fig. K. When soldering make sure to flush the joints to assure strength. Now the cuff link is ready to be pickled and then polished.

If enamel is to be used it is applied after all soldering has been completed. Before firing, the joints are heavily protected with yellow ochre.

CARVED CUFF LINKS





Chapter XVI

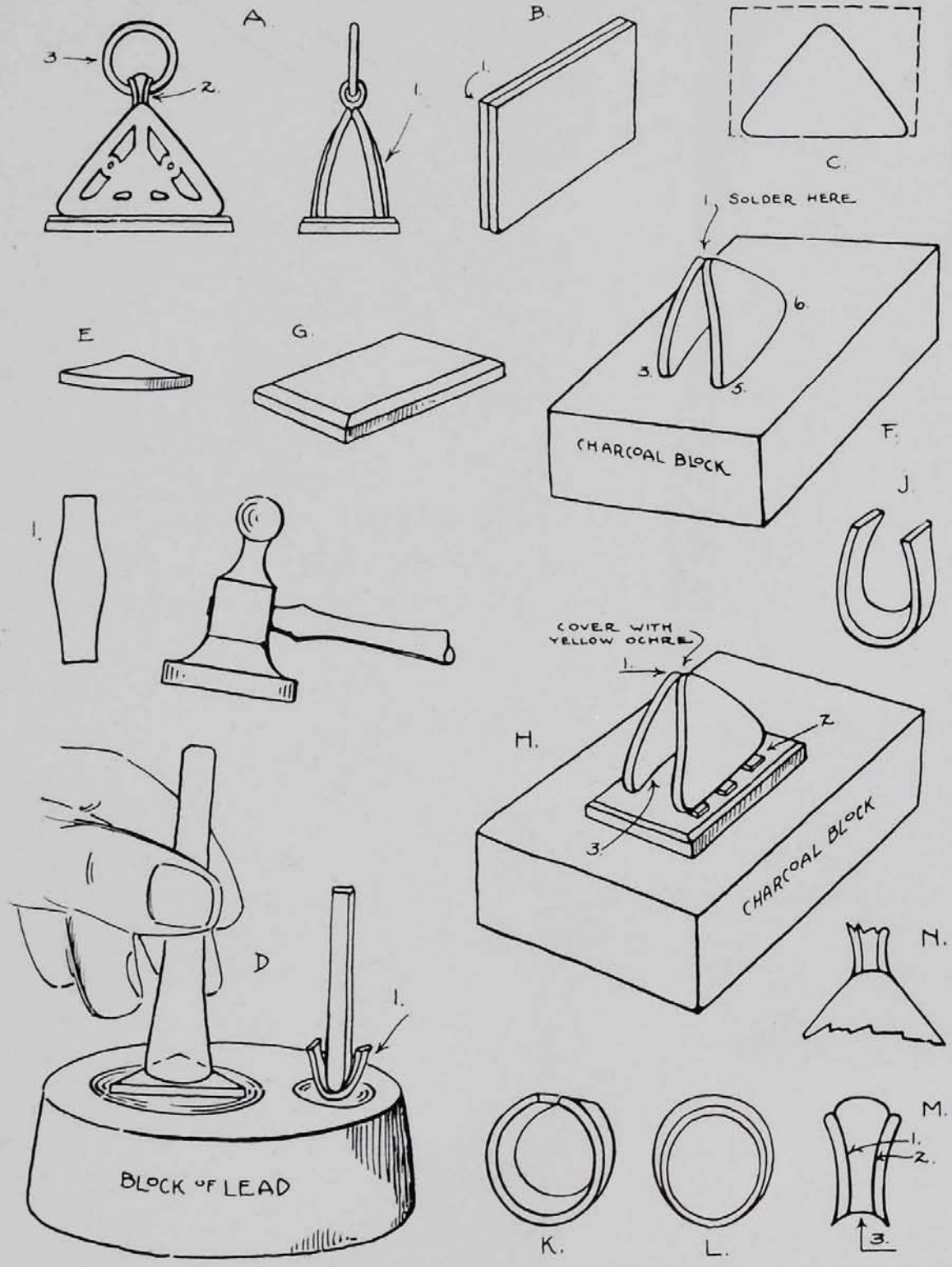
Fobs and Chains

THE SEAL WATCH FOB

PROBLEM 30. To make the watch-fob as shown by Fig. A, Plate XL, take two pieces of silver No. 18 gauge $1\frac{1}{8}$ " x $1\frac{5}{8}$ " and solder together with a very little solder at two corners as at 1 and 2, Fig. B. This is done so that both pieces can be pierced at the same time. Glue the design to the metal and pierce the small openings first. When this has been done the outline of the fob may be sawed. This will give us Fig. C. All edges and openings are now trued up with the file. Fig. A 1 shows that the sides of the fob are slightly domed. Take a lead block and hollow out a place to receive the metal to be domed as Fig. D. Place the metal in the hollow and with a punch and hammer shape the metal like Fig. E. When both pieces have been domed in this way, place them on the charcoal block as shown by Fig. F. Note that points at 1 should touch, as they are to be soldered, and the base lines 3-4 and 5-6 should be parallel. When soldering at 1 use plenty of solder.

To make the base take a piece of silver No. 14 gauge 1 " x $1\frac{3}{4}$ ". True it up with the file and bevel the edges as at Fig. G. Now scrape where the sides are to be soldered to the base and place in position on the charcoal block as at Fig. H. To prevent the side pieces from unsoldering at 1, cover the joint with yellow ochre. Borax the joints to be soldered and place about three pieces of solder on the outside of each side as shown at H, 2. When soldering make sure that the solder flows under the joints and comes through to the

SEAL FOB



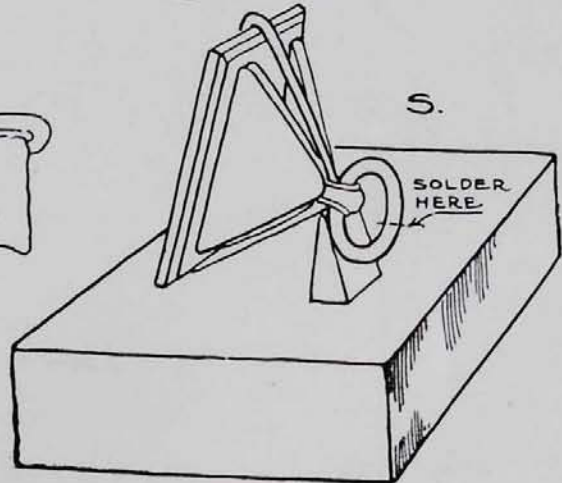
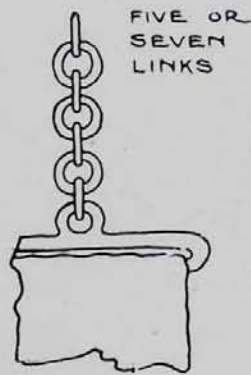
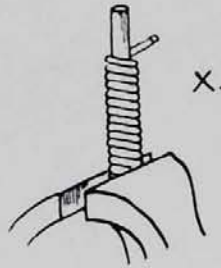
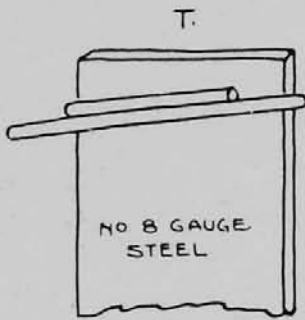
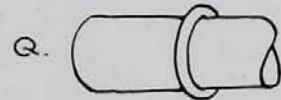
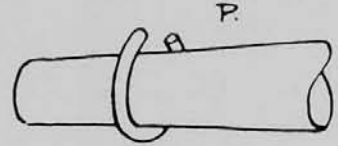
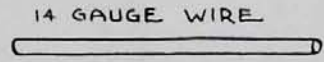
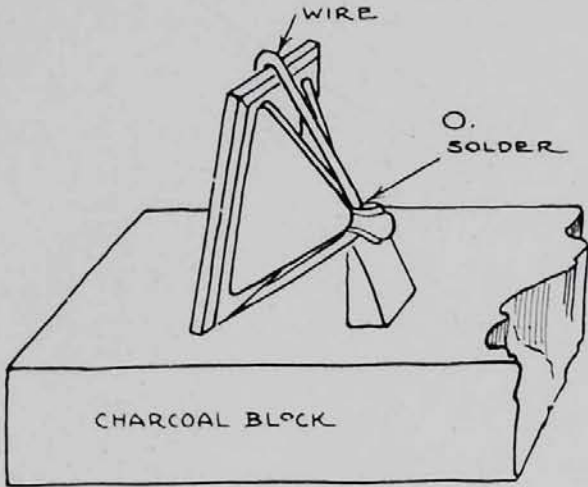
inside, Fig. H, 3. The piece of work is now pickled to remove the borax, making it easier to see that a good joint has been made.

To make the loop, Fig. A 2, take a piece of No. 18 gauge about $\frac{3}{8}$ " x 1" and saw to pattern as at Fig. I. Now make a hollow in the lead block, Fig. D 1, and shape the metal as shown at Fig. J. The rest of the bending may be done with the round nose pliers bringing the ends together as shown at K. The ends are filed, butted and soldered. After the ends are soldered as at L the outside is filed to look like M. The two lines, M 1-2 are made by using a three corner file. It is now filed to fit the point of the fob at the top, Fig. N; Fig. M 3 shows the part cut away. The loop is now wired to the top and soldered. Fig. O shows the position of the fob on the charcoal block and the arrow shows where solder is to be placed. Be sure and use plenty of borax and solder to flush the joint. The fob should be made to stand as shown by putting a support under the loop.

To make the ring for the loop, Fig. A 3, take a piece of No. 14 gauge wire $1\frac{3}{4}$ " long and bend around an arbor, Fig. P, Plate XLI. Use the mallet to bring ends together. Solder after filing the ends flat. Now place the ring back on the arbor, Fig. Q, and make it circular by tapping it lightly with the wood or rawhide mallet. Saw the joint open, but do not disturb the shape of ring. Open the ends enough to pass ring through loop as shown at R. After the ring has been passed through the loop, bring the ends into line again and solder once more. A piece of wire bound across the diameter of the ring may be used to make ends touch if necessary. Fig. S shows position of fob while ring is being soldered. This part of the fob is complete and after pickling can be polished and finished.

We next make the top part of the fob. Take a piece of 14 gauge wire and bend around a piece of steel as shown by Fig. T. The steel used here was 8 gauge

SEAL FOB



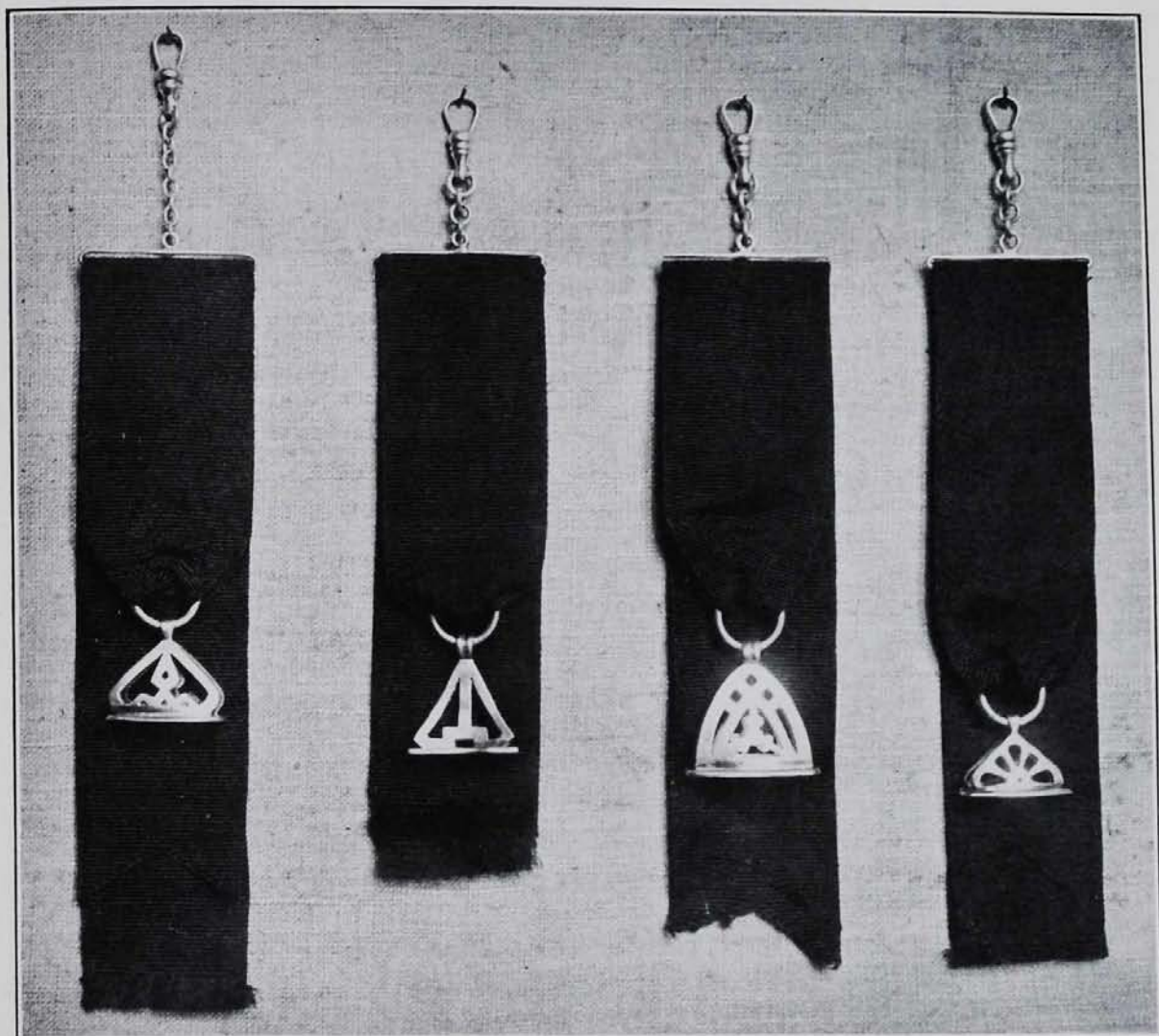


FIGURE 106

and $1\frac{3}{4}$ " wide. The width should be the same as the width of the ribbon to be used for the fob. Saw the wire in the middle, Fig. U, then solder ends, Fig. V. Now take some No. 16 gauge wire and make the links for the chain as described on page 122. Take one of these links and solder to V, as shown at Fig. W. Now connect this link and the link of the swivel with a chain of five or seven links. Each link should be hard soldered. This part of the fob is now completed and ready for the polishing and finishing. The ribbon should be about $\frac{3}{8}$ -yard in length and $1\frac{3}{4}$ inches wide, and made up as shown in Fig. 106.



FIGURE 107

in the illustration lend themselves to this beetle design. In making the fob, No. 18 gauge metal is used.

PROBLEM 31. Fig. 107. In making this fob a bezel is first made of No. 24 gauge metal. This bezel is then soldered to a piece of No. 18 gauge metal which forms the back of the fob. The effect obtained of braided wire next to the setting is obtained by twisting two strands of No. 20 wire to the right and two to the left, and placing them side by side. A little solder is run along each twist to keep it together. We take one of the twisted wires and bend it to fit the bezel, and solder the ends together and then, when carefully fitted to the bezel, it is soldered to the back. In soldering this in place we must be careful to keep the solder from running up on the bezel. After the inside twist is in place the outside one is made and soldered in the same way. The outer edge of the piece forming the back is beveled a little with the file, reducing the thickness at the edge. The loop and ring at the end of the fob are made of No. 14 round wire.

PROBLEM 32. Figure 108. The opal matrix stone in this fob suggested the design. The unusual markings and beautiful iridescent colors which are lost

The outline of the beetle is drawn on the metal and scratched with the scratch awl to make it permanent. It is then placed on the lead block and dapped into shape with various sizes of dapping tools. Much filing and bending one way and another is necessary to work this into shape. When the beetle is fairly well modeled the opening for the stone is made and more filing is done to make a good fit. The bezel which holds the stone in place is soldered to the under side or back of the beetle. As the legs were made hollow by the dapping, it is a good plan in such cases to solder a piece of heavy wire in the hollow to fill it up, as well as to make it stronger. The antenna, or loop at the top of the head, through which the ring passes, is also made of wire and soldered at the back. A little filing at the front makes this wire appear as though it were a part of the front. The eyes of the beetle are almondines. Two holes are drilled the right size, and a piece of tubing which projects a little above the surface of the head, soldered in each hole. A shoulder is cut for the stone to rest on and when the rest of the fob is finished and polished, the stones are set.



FIGURE 108

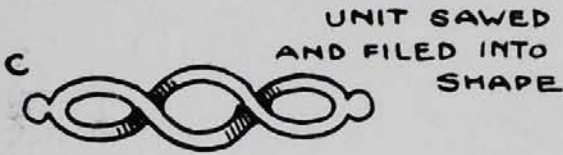
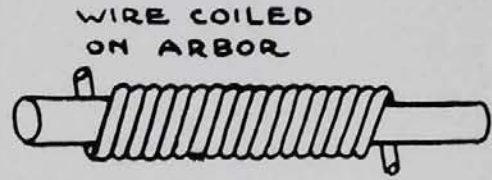
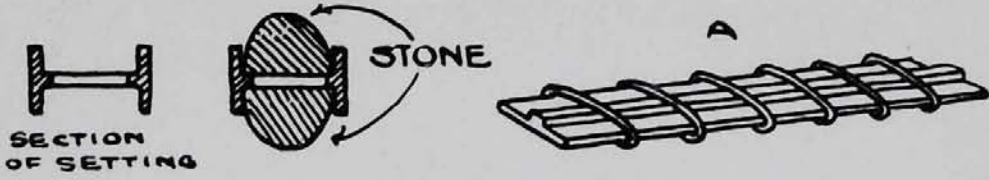


FIGURE 109

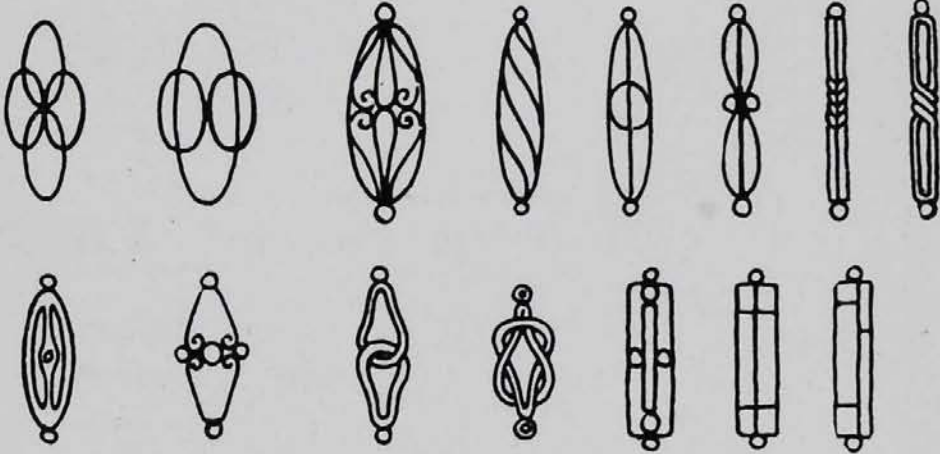
CHAINS

PROBLEM 33. Figure 109. This chain is 60 inches long and is made of small oval links with six decorative units. A decorative unit of this kind used in a chain should be double sided as it has neither front nor back. The unit here illustrated is composed of six turquoise stones, three on each side, set in a piece of No. 18 gauge silver which is modeled in such a way as to give it an entwining effect about the stone. The outline of the unit is sawed and filed into shape. The bezels are then made for the stones which in this case are double sided ones. Take a strip of No. 26 gauge metal $\frac{1}{16}$ of an inch wide and a strip of No. 24 gauge $\frac{3}{16}$ of an inch wide and solder the narrow strip in the centre of the wide one. Fig A, Plate XLII. A piece of fine binding wire is used to hold the strips together

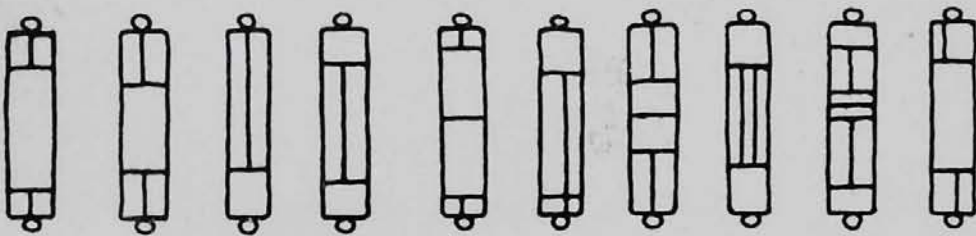
while soldering. After soldering the strip is pickled to remove the borax. The strip is then bent into shape to fit the stone and the ends soldered, Fig. B. When bezels have been made for the 36 stones, holes are drilled in each of the units and the bezels are carefully fitted and numbered. The six units with the bezels in position



ROUND WIRE UNITS



RECTANGULAR WIRE



DEVELOPMENT OF RECTANGULAR UNIT

are placed on the charcoal block and are all soldered at the same time. To make the links that connect the units, wind the wire around an arbor the shape and size desired to make a coil as shown below A. One end of the arbor can be held in the vise while the coiling is being done if only a small number are needed. If a lathe is at hand the coiling can be done much more quickly. The coil is slipped off the arbor and the links are sawed apart. These are then linked together and soldered. A small ring or link is soldered to each end of the unit. Fig. 110 shows a chain with units made of wire and Fig. 111 shows one in which the units of wire have been alternated with a bead of tourmaline. Plates XLII and CXLI suggest a variety of unit arrangements for chains. The shape of the arbor determines the shape of the link, although they may be made in many shapes—oval, round, and oblong ones are more frequently used.

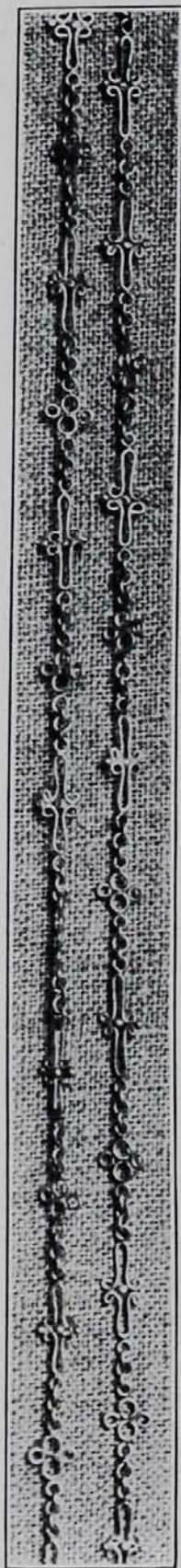


FIGURE 110

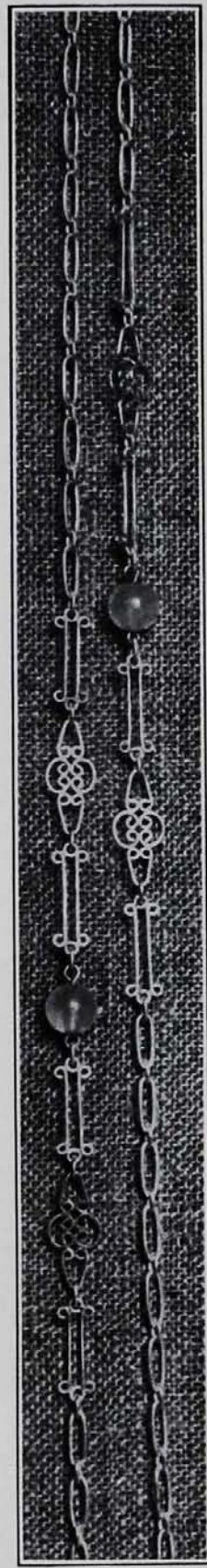


FIGURE 111

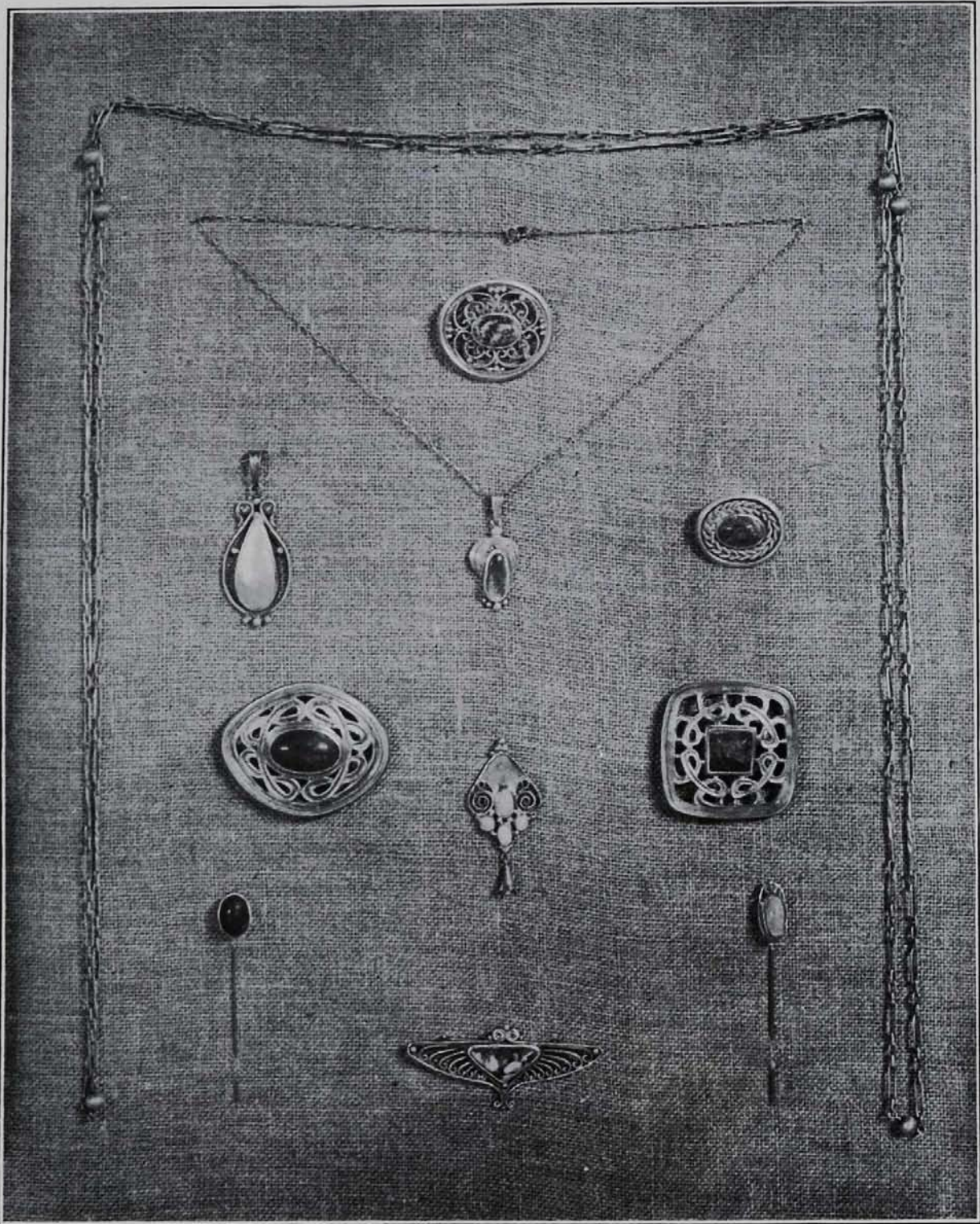


FIGURE 112



FIGURE 113

A Class of Normal Art Students
in Jewelry Making



Enameling

THE art of enameling has been practiced from very early times, dating far back in history. Probably it is unknown when the practice commenced. Many of the early examples now to be seen in the British Museum date as far back as the tenth century B. C. Enamel in its simplest forms was in use among the Egyptians, Phoenicians, Assyrians, Greeks, Romans and Etruscians, and is seen at its best in association with jewelers' and goldsmiths' work.



The *Egyptians* used a fine royal blue glaze on the small images of mummies which were placed in the tombs to be the servants of the dead in the next world, but its use upon metal to any great extent is more doubtful.

In the early *Greek work* it is quite probable that the glass blowers and jewelers worked together. A ring in the British Museum with a band of glass about it gives evidence of this fact. Although there are many examples in the museums of Europe of work done up to the fourth century A. D., we know more about the art of enameling from then on.

It was about this time that the art was practiced by the Greeks at Byzantium and by the Celts in Ireland. The Greeks at Byzantium practiced what was termed cloisonné and the Celts the champlevé form of enameling, and for five centuries their work was unrivaled for its beauty. During the tenth century the art of the Byzantine enamellers began to decline and at the same time it sprang up in Western Europe.

About the fourteenth century it was carried from Constantinople across Asia to China by artificers who set up workshops on their way. Toward the end of the sixteenth century the art was carried from China into India and Japan.

[181]

Niello Composition:

Silver	3 parts.	} Poured into Powdered Sulphur.
Copper	1 part.	
	1/2 part.	

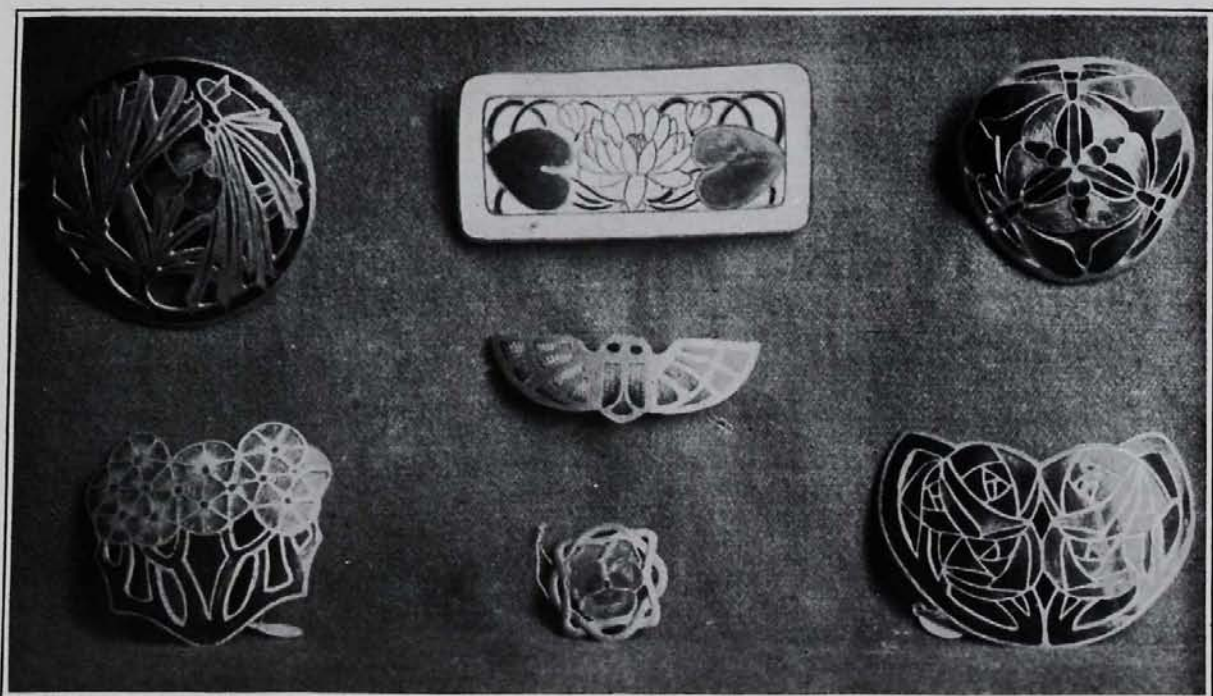


FIGURE 114

The art was introduced into Europe by Theophano, a Byzantine princess who, when she married Otho II brought with her enamellers from the East. Her interest in craftsmanship resulted in the art being practiced in Trives, Cologne, Maestricht and Verdun and probably found its way from these places to Paris. It was not until the twelfth century that the art was practiced at Limoges which was a Roman colony and was known for the quality of its goldsmiths' work. The prosperity of the place attracted Byzantine and Venetian craftsmen and during the thirteenth century an enormous quantity of work was turned out which was both good and bad. In the fourteenth century the art declined to such an extent that it went out of fashion altogether.

Toward the end of the fifteenth century, however, the art was revived again and Limoges started up her enameling ovens with renewed vigor, handing down to us priceless treasures of the enameler's art. The best Limoges enamels come from such artists as the Penicauds, Courtney, Limosin, Raimond and Landin.

Enameling as a truly fine art again began to die in the 17th century and was not practiced to any extent till the middle of the 19th century. The names of Herkomer, Fisher, Varley and Stabler are associated with the best modern work.

ENAMEL POSSIBILITIES

With the use of enamel it is possible to reproduce the various play of colors in opals, in laboradorite, the translucency of such stones as the agate and onyx and a brilliance of transparency equal to that of emeralds and rubies. It is made to last and if kept out of the ground and protected from actual rough usage it will suffer little deterioration at the hand of time. Nothing but burial in damp earth can impair it.

This peculiar gem-like quality unlike anything else in art materials, gives it a peculiar charm and when applied to objects in metal it adds a great deal to their attractiveness and value. Good judgment, however, must be exercised in the amount of enamel used. In some articles such as pieces of jewelry, little enamel should be used, thereby giving it the character of a gem. There are many objects to which enamel may be properly applied, such as scarf pins, cuff links, brooches, buckles, clasps, pendants, necklaces, hat pins and fobs.

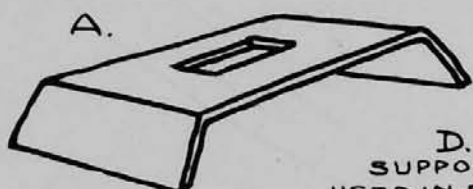
KINDS OF ENAMEL

There are three kinds of enamel, transparent, translucent, and opaque. The transparent reflects the color and surface of the metal, while the opaque gives color on the surface only. The translucent admits the light but partially.

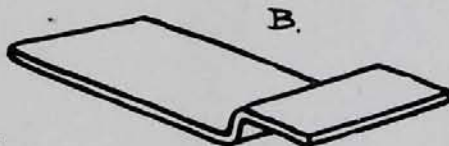
COMPOSITION OF ENAMEL

Enamel is composed of a flux combined with oxides of metals. The flux is composed of silica (powdered flint or sand) minimum which is red lead, nitrate or carbonate of soda, or potash, all melted to-

ENAMELING TOOLS



A.
REST FOR
IRREGULAR
WORK



B.
SHEET IRON SHOVEL
TO REST WORK ON
WHILE FIRING.

D.
SUPPORT
USED IN FIRING
TUBING



C.
CIRCULAR TRAY TO
REST WORK ON WHILE
FIRING

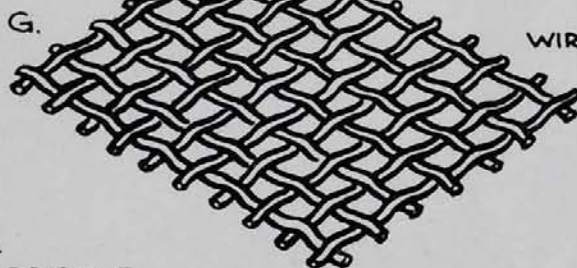


MADE OF SHEET IRON

E.
WIRE
STAPLE

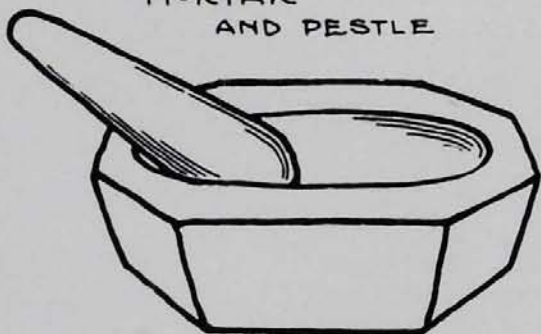


F.
SAUCER FOR
HOLDING ENAMEL

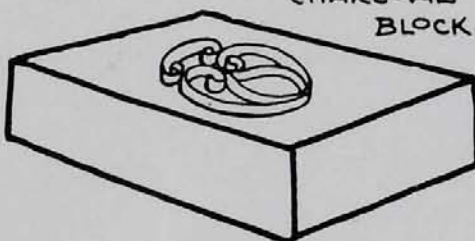


G.
WIRE NETTING FOR
HOLDING WORK
WHEN USING
BLOW PIPE

H.
MORTAR
AND PESTLE



I.
CHARCOAL
BLOCK



J. SPATULA



K. BRUSH



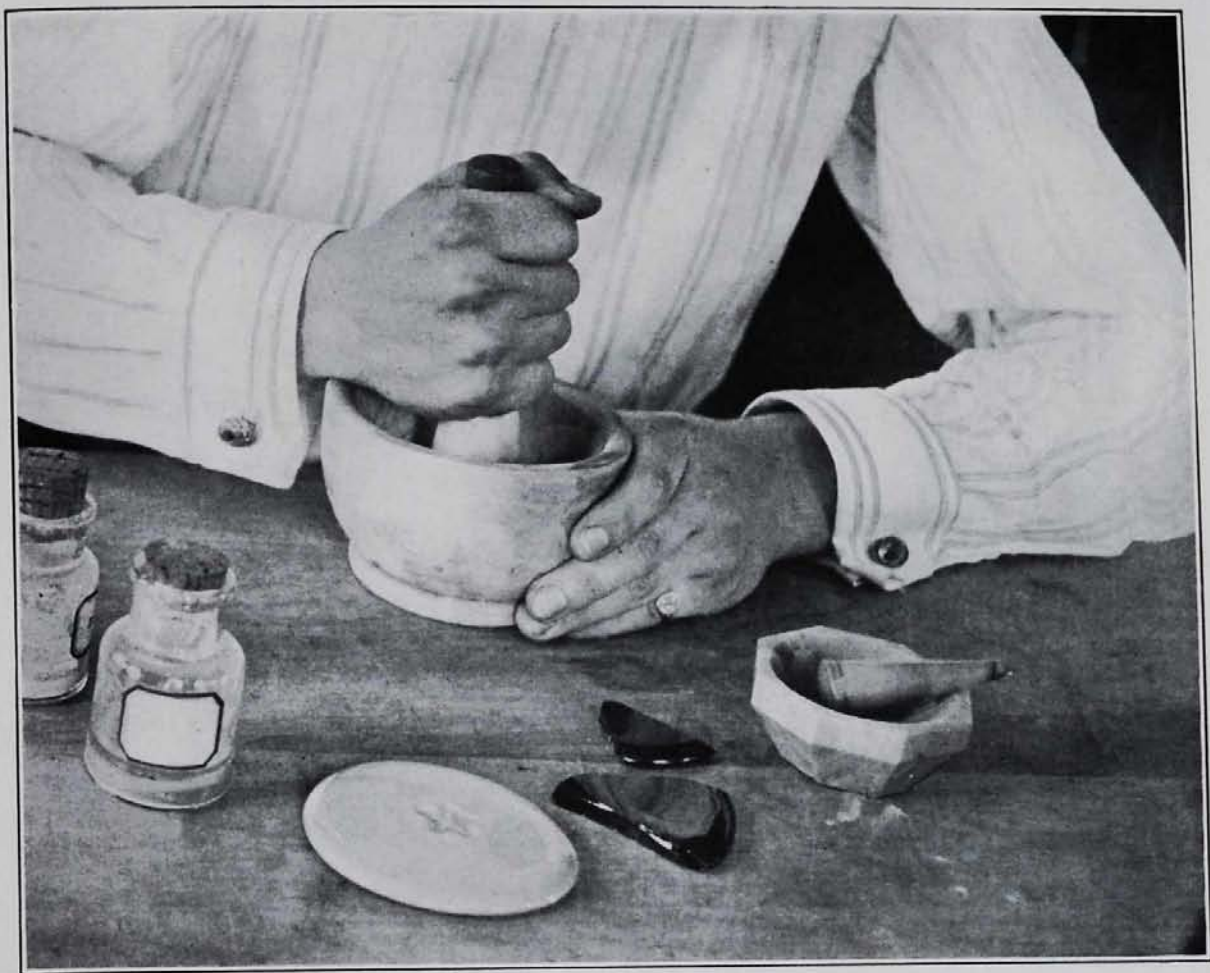


FIGURE 115. Grinding the Enamel

gether in a crucible until there are no bubbles left in it. This flux which is the base of all enamels is combined with different metallic oxides in various proportions. There is no limit to the range of color that can be produced except that vermilion and lemon yellow cannot be obtained.

Transparent enamels are made opaque by adding oxide of tin and white arsenic. As the metallic oxides give the required colors, and as these colors are liable to change under various degrees of temperature, great skill and patience are necessary to determine the exact degree, and the time also of exposure which will insure the hue and no other, intended by the artist.

Because of the vast amount of knowledge and experience necessary to make enamel, the craftsman or jewelry worker will do well to leave that part of the

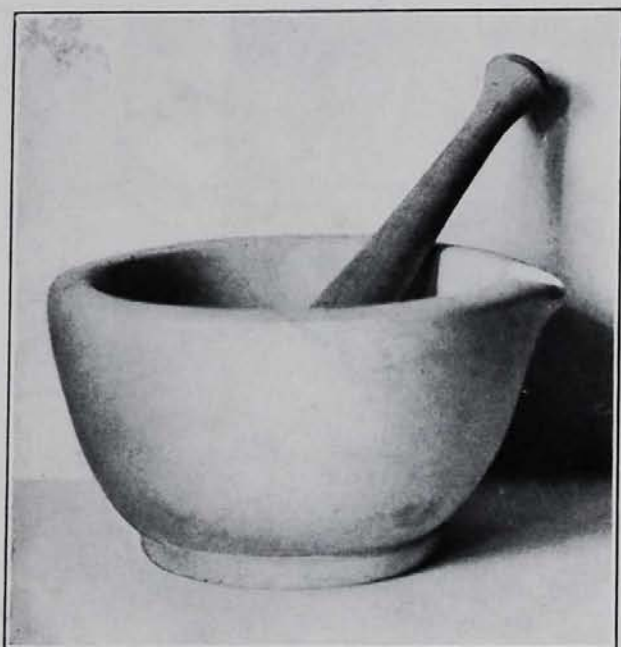


FIGURE 116
Porcelain Mortar and Pestle

thick, although it is sometimes made in lump and rod form. The cake or lump is first broken into small pieces. One or two of the pieces is then broken up again until it is about as fine as coarse sand. If only a small quantity is wanted, it can be rolled up in a piece of heavy wrapping paper while it is being broken up. The paper prevents it from flying about. After being broken, it is then placed in a porcelain mortar and, with water enough to cover it, it is ground about as fine as fine sand, with the pestle. For very small work or jewelry it is ground much finer with the use of the agate mortar and pestle. The water is poured off and the enamel rinsed several times until all of the milky substance disappears. Unsatisfactory results often come from

art with the one who makes it his profession. There are difficulties enough in handling the enamel after it is made, to tax the ability of the amateur to the limit.

GRINDING

The best hard enamel, mostly made in France, usually comes in thin cakes varying in size from two to six inches in diameter and about three-eighths of an inch

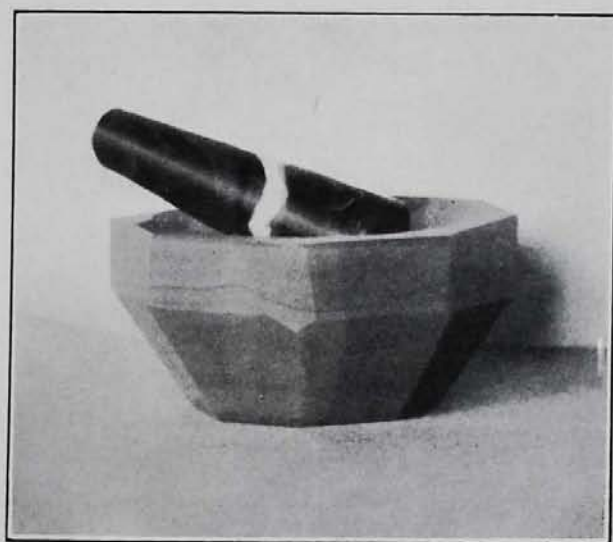
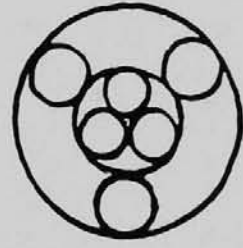
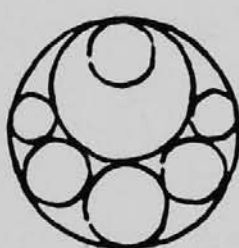
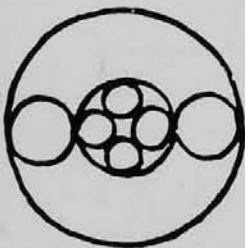
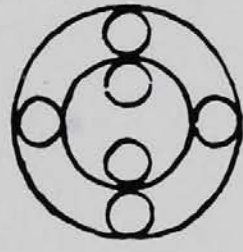
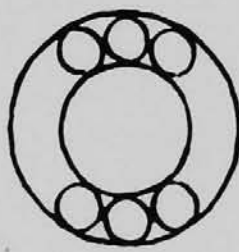
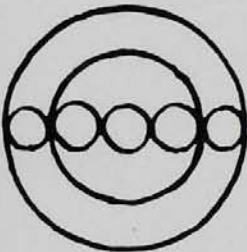
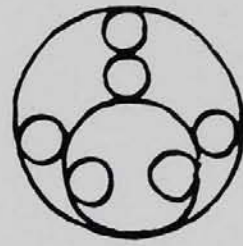
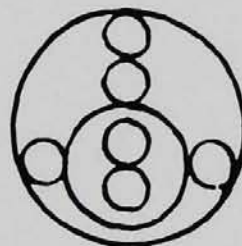
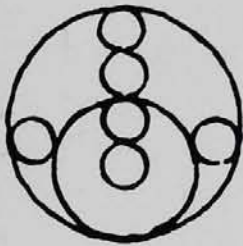
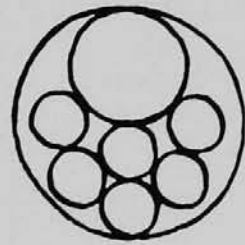
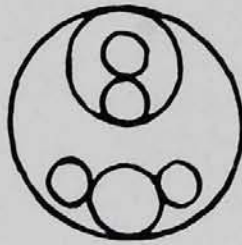
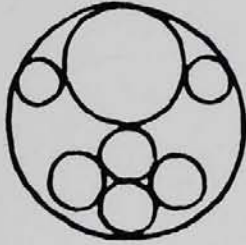


FIGURE 117
Agate Mortar and Pestle

ARRANGEMENTS OF CIRCLES WITHIN
CIRCLES FOR CLOISONNE ENAMEL



lack of care in washing the enamel. It is a good plan to have a dish of some kind to pour the washings into to save enamel that otherwise would be wasted. This waste enamel, as it is called, is used for counter enameling. After being washed, the enamel is removed from the mortar to a small saucer, by the use of a palette knife.

PROCESSES USED

There are seven methods or processes used in enameling, which are as follows: Cloisonné, Champ-levé, Painted, Grissailé, Bassetaille, Plicque a Jour and Niello.

THE CLOISONNÉ

In the Cloisonné method the outline is all-important, and as this outline consists solely of the wire which encloses the various fields of color, it must be simplified to the last degree.

With its severe limitations it demands at once a fine sense of color and the most careful drawing.

Cloisonné enamel is produced by setting up cells or cloisons on the surface of the object or material to be decorated. This is done by bending flat or rectangular wire into the shapes called for in the outline of the design and then soldering these wire units on to the material which forms the background. The wire thus forms cells into which the enamel is placed and then melted or fused in the furnace.

At first a careful tracing is made for the design, giving all the lines that are to be in wire. This tracing is then placed on a charcoal block which has been faced off level with the use of a file. Now using a small pair of pliers the wire is bent into the shape of the design, fitting all of the lines on the tracing paper. These pieces of wire are then held in place by the use of small staples made of iron wire which are forced through the tracing into the charcoal block, pinning the cloison wire to the charcoal. After the design is completed

and the parts all fitted together the joints are coated with borax. Small pieces of solder are then applied to each joint and the whole is soldered with the use of the blow pipe flame. The paper tracing burns away during the soldering operation. After removing the iron wire staples, the wire design is pickled to remove the borax. The metal plate that is to form the background is next thoroughly cleaned and coated with borax. Now place the wire design on the plate and press it gently until it conforms with the surface of the plate. Small pieces of solder are placed at intervals along the wire forming the design and after coating with borax and binding lightly with iron wire it is placed in the furnace until the solder runs. Boil the plate out again in the pickle to remove all borax and thoroughly clean it. When this has been done it is ready to apply to the enamel.

CHARGING. Assuming that the enamel has been ground to the required degree of fineness and carefully washed as previously described on page 186, a small quantity of each color to be used is placed in small porcelain saucers. If the design is carried out in copper, a saucer of flux is necessary to start with. In order to retain the transparency of the enamel, a coating of flux must be applied and fired on before applying the colors. If silver or gold is used, the flux is not necessary. While the enamel is still wet, which allows its being spread more easily, it is applied to the object with a metal tool or pencil called a spatula, which may be made from a piece of steel wire about $\frac{1}{8}$ " in diameter. It is made a little flat at one end and pointed at the other. With this tool the enamel is carried from the saucer to the piece of work, and it is possible to work the enamel into the smallest cloison by using the pointed end. A piece of clean white blotting paper and a piece of linen cloth is needed to dry the tool on at times and to absorb some of the moisture from the enamel when it is in place. After the cloisons have all

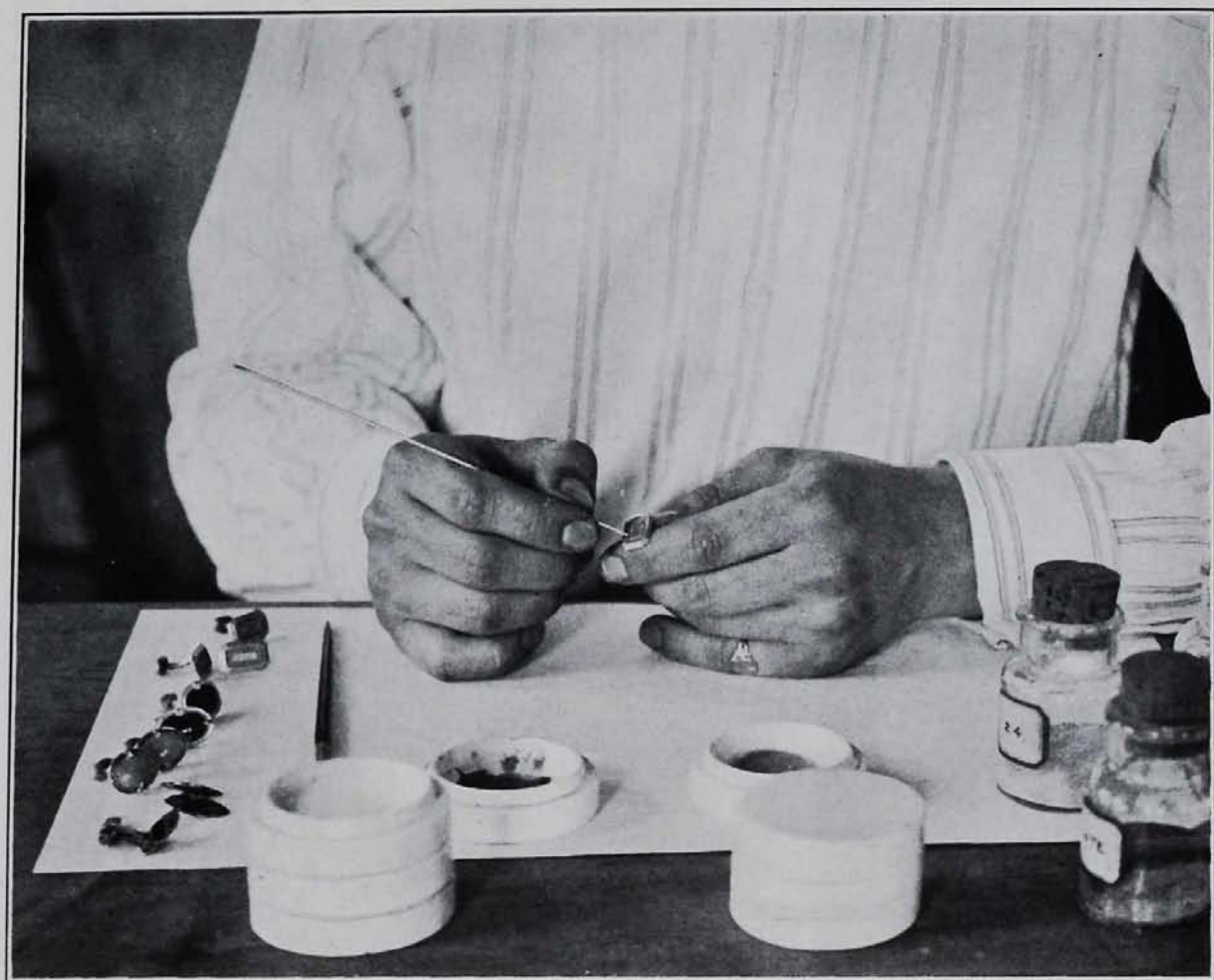


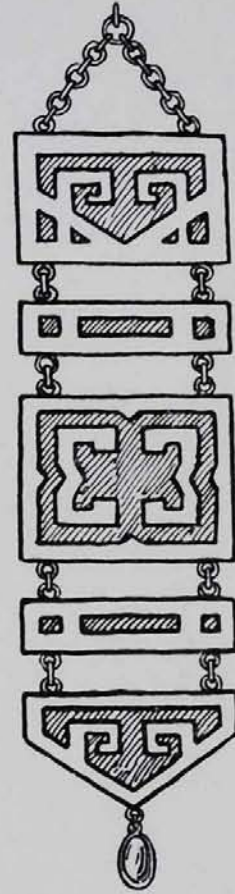
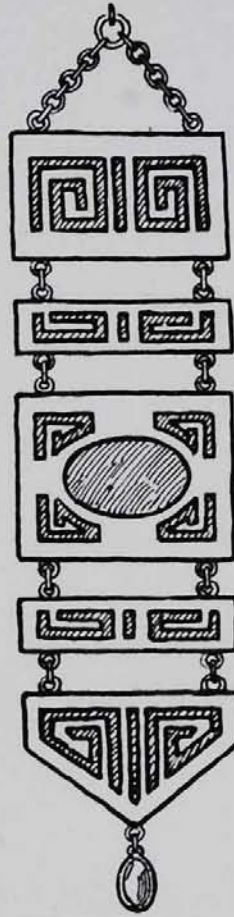
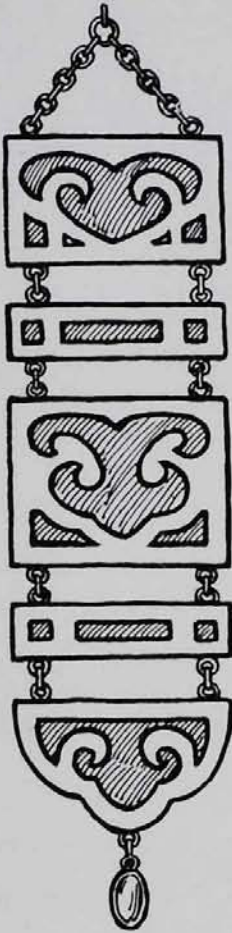
FIGURE 118. Charging

been filled the piece of work is put in some warm place and left until all of the moisture in the enamel is thoroughly evaporated. It is then ready for firing. Small pieces of work may be fired with the blow pipe or bunsen burner, and good results are obtained in this way, but the firing is usually done in a kiln made for the purpose.

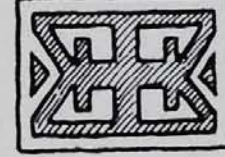
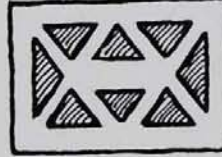
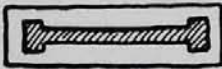
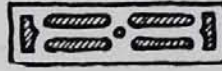
CHAMPLEVÉ

In Champlevé enamel cells or channels are cut in the metal to receive the enamel. A partition or border must be left between the cells to keep the enamel from running into each other when it is fired. When the enamel is applied in this way it has the appearance of inlay. To prepare the metal for the enamel, a cement stick or board is first necessary to hold the work firmly

FOB IN ENAMEL
ORNAMENTATION VARIED



SUGGESTIONS OF UNITS



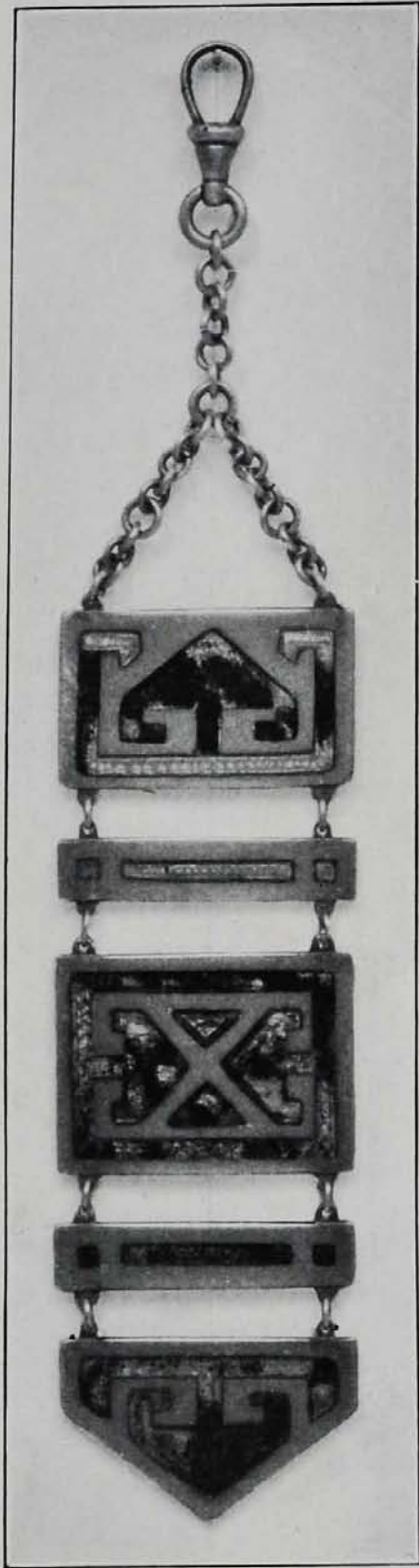


FIGURE 119

in place during the cutting of the cells or channels which is done with the engraving tools. The charging or applying the enamel is done as in the Cloisonné work. For beginners this method is preferable to Cloisonné as first attempts are more successful.

PAINTED ENAMEL

Painted enamel is done on a plate of metal without the cloisons or channels as in Cloisonné or Champlevé work. The plate is shaped or domed a little to strengthen it. In order to counteract the contraction of the enamel on the face of the plate, it is necessary to back it up with counter enamel, that is to give the back a coat of enamel to be fired at the same time with the first coat on the face of the plate. To make the counter enamel stay in place while working on the face of the plate a drop or two of gum tragacanth is used. This is thoroughly mixed with the enamel before it is applied and when it is in place the gum makes the enamel stick even when the plate is turned over. When the plate is fired the gum burns out of the enamel. The first coat of enamel on the face may be one of flux

leaving the entire surface transparent, or a coat of opaque white may be used on which the transparent colors are applied later. In painted enamel the colors



may be used much the same as in water color where one color is mixed with another to get the required effect. In painted enamel a small sable hair brush is used to apply the enamel. If, after firing the first time, the colors do not appear as planned another application is made and fired again, and this may be done several times until the desired effects are obtained.



GRISSAILLÉ

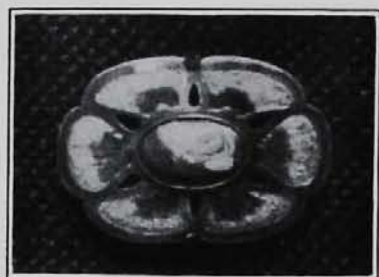
In grissailié enamel the plate is prepared the same way as for painted enamel. A coat of counter enamel is applied at the back and a coat of flux on the face of the plate. After the first firing the design or decoration is carried out in opaque white. This is applied in such a way as to give a modeled or relief effect. After the opaque white has been fired a coat of transparent enamel is applied using any color desired covering the entire surface of the plate. The decoration being carried out in the white with the covering of color gives a most interesting effect of light and shade.

BASSETAILLE

Bassetaille enamels are made by chasing or engraving the design or decoration on the plate in relief. The enamel, which should be either transparent or translucent is then applied all over the surface. The different depths of the color on the modeled or engraved surface produces different depths of tone in the color used and gives unusually rich effects.

PLIQUE-A-JOUR

Plique-a-jour is something like cloisonné except that it has no back. The cloisons or design is carried out or made in the same way as cloisonné. The different units forming the design are soldered with a



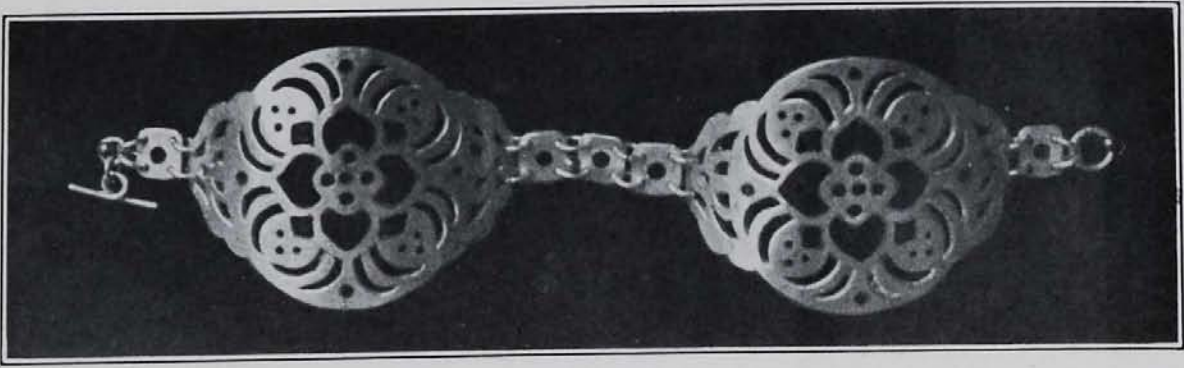


FIGURE 120

harder solder than is usually used. When all the units are together it has the appearance of very fine filigree or pierced work. A design for a piece of plique-a-jour enamel could be pierced from a sheet of metal if done by a skillful craftsman, but it requires much care in keeping the metal lines separating the enamel uniform in thickness and is a much slower process.

When the piece of work is ready, it is placed on a sheet of mica or a plate of fire clay which serves as a background for the enamel. The enamel is then applied as in cloisonné and fired. The enamel will settle considerably when fired but, after cleaning, the depressions are refilled and again fired. It may be necessary to do this several times before the desired results are obtained. After the cloisons have all been filled the next step is to stone both front and back off, leaving a perfectly smooth surface. A successful piece of plique-a-jour enamel carried out in transparent colors has the effect of a beautiful stained glass window. This process requires a great deal of skill and care to obtain satisfactory results.

FIRING

After the charging has been done the piece of work is placed in a warm place to dry out the water in the enamel. It is very important that the enamel is entirely free from moisture before firing. The firing is usually done in a kiln made for the purpose although small pieces may be fired over a bunsen burner or with

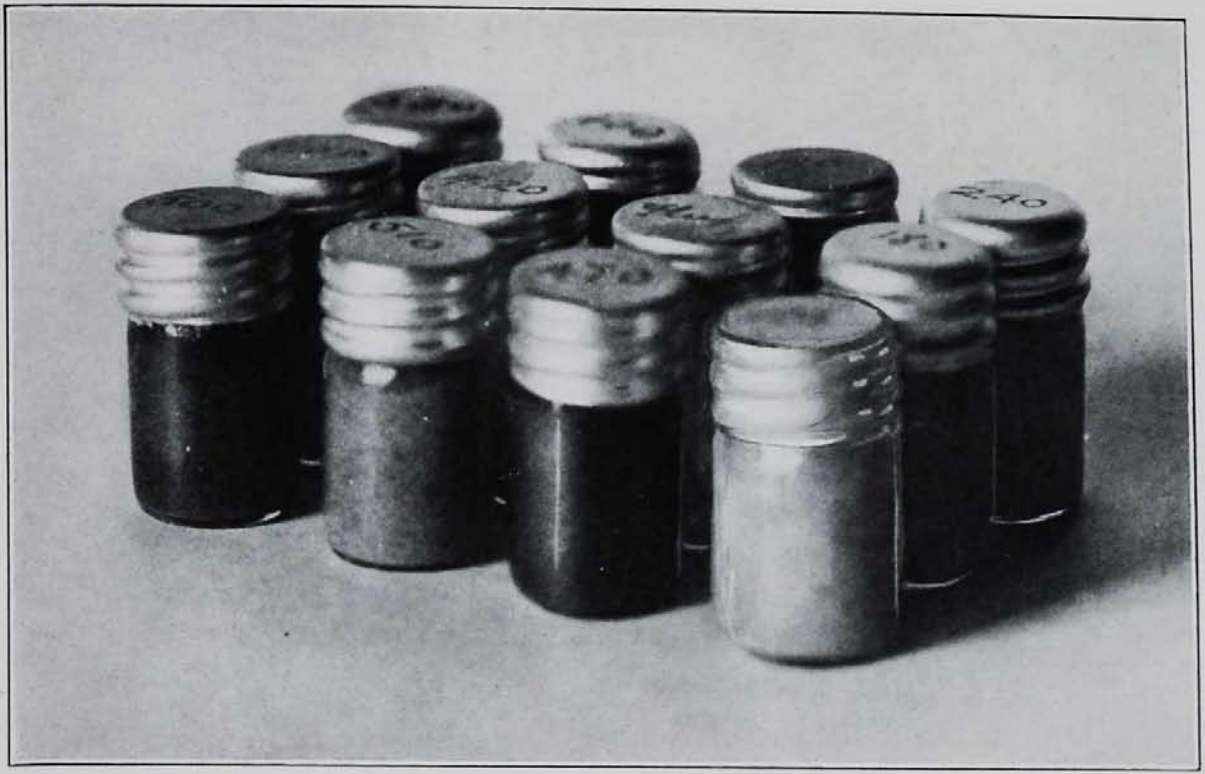


FIGURE 121

a blow pipe. Assuming that the moisture has evaporated from the enamel and that the piece is ready to fire we first notice that the enamel is now a very fine powder and must be handled very carefully as the slightest jar will displace the enamel and necessitate going all over the work of recharging. The piece of work is placed on a small tray or shovel, Fig. B, Plate XLIV, made of sheet iron for convenience in handling. A pair of enameling tongs are used to lift the tray or shovel while carrying it to and from the kiln. The work should be held at the opening of the kiln for a minute or two to heat it gradually before inserting into the kiln. After it is in the kiln the enamel should be closely watched as the firing goes on and when the enamel settles and glazes or looks like a liquid all over, it should be withdrawn at once and allowed to cool very slowly. It should never be placed on any cold substance as it would only result in the enamel cracking. If, when cool, it is found that the enamel has settled more than desired, the piece of work is again cleaned as at first, more enam-



FIGURE 122. Stoning

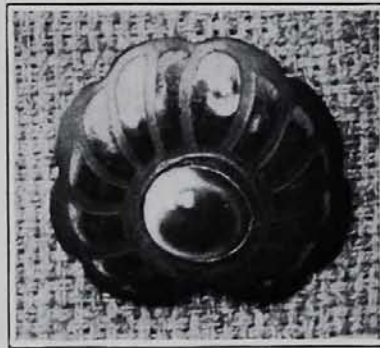
el applied, and again fired. The enamel may be left just as it comes from the kiln or it may be stoned down level with the surface of the metal. The firing process is one that requires a great deal of practice and close attention to get satisfactory results.

STONING

In Cloisonné, Champlevé and Plique-a-jour work it is not easy to apply the enamel without leaving it somewhat uneven when it comes from the kiln. The enamel may be higher than the surface of the metal or it may be lower in places and this unevenness is undesirable. To give the piece a uniform surface it is necessary to work over it with enamel files or stones varying in degrees of fineness. The piece of work to be stoned is held on a pad or board which is placed in a sink or some place where plenty of water can be used.

The board should slope away from the worker so that the water which should be freely used will run off. The stones or files are dipped in the water and then rubbed over the enamel back and forth until the required surface is obtained. Sometimes flour of pumice is used with the stones to hasten the process. A coarse file is used first to rough it down, then one considerably finer and finally a scotch stone is used to finish the surface. If transparent enamel is used it is necessary to fire it again just enough to give it a glazed surface. In using opaque enamel this is not necessary. Finally the work is buffed a little to brighten the surface.

NOTE. The beautiful color effects obtained in the combination of enamel and metal are completely lost in photographic reproduction, making the illustrations in this chapter lifeless and unsatisfactory.



Chapter XVIII

Modeling and Casting

MODELING

MATERIALS

A BOARD, slate, piece of glass or a flat slab of plaster is first needed to work on. The size of this may be governed by the size of the work to be done. For large work modeling clay is used, for medium-sized work plasteline, and for small work hard wax.

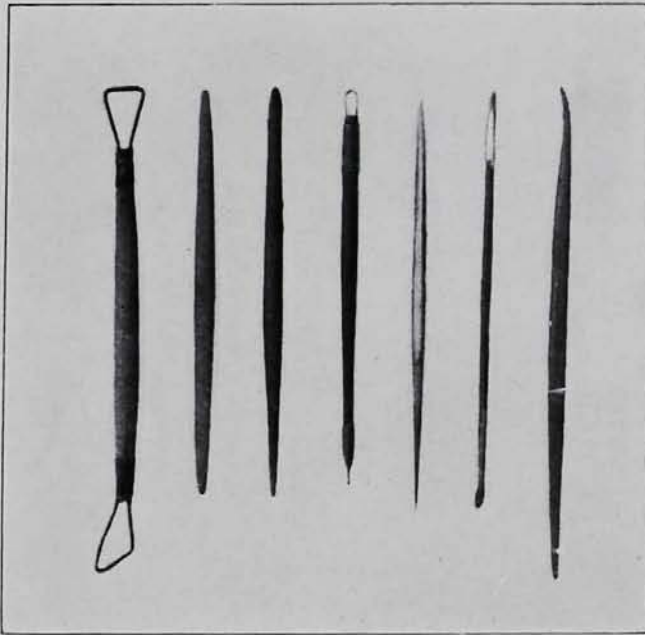


FIGURE 123

TOOLS

The tools necessary for modeling are few in number, Fig. 123, and should be made by the student, although they may be purchased. The purchased ones, however, always need more or less adjusting and re-shaping. Boxwood sticks may be had of various sizes at hardware stores carrying jewelers' supplies and with the use of files and sand paper they may be shaped as

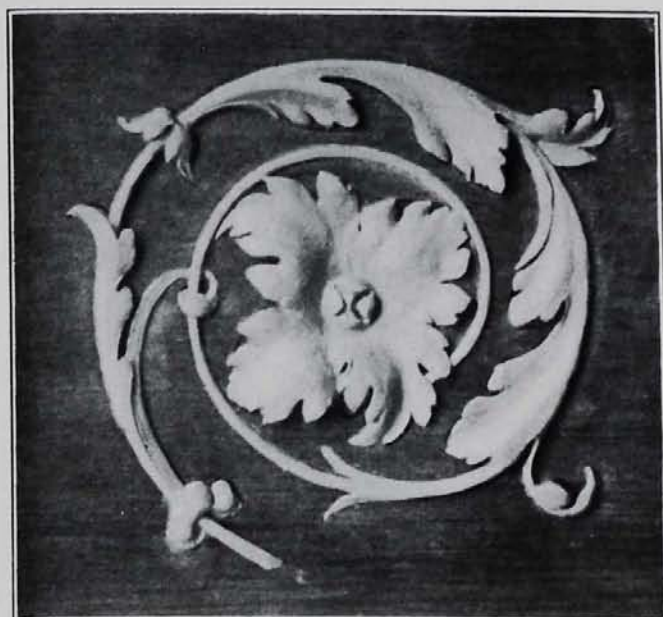


FIGURE 124

desired. One or two wire tools are found useful and are not difficult to make. A piece of wire of the required size is bent into shape as shown in the illustration and with a very small binding wire is bound to the handle. It is often a convenience to have two different shapes, one at each end of the handle.

CASTING MATERIALS

Plaster of paris, a little cotton seed or olive oil and a small piece of soap are all that are necessary.

TOOLS

A bowl or pan, a spoon, a knife and two or three soft brushes will be all that is needed.



FIGURE 125



FIGURE 126

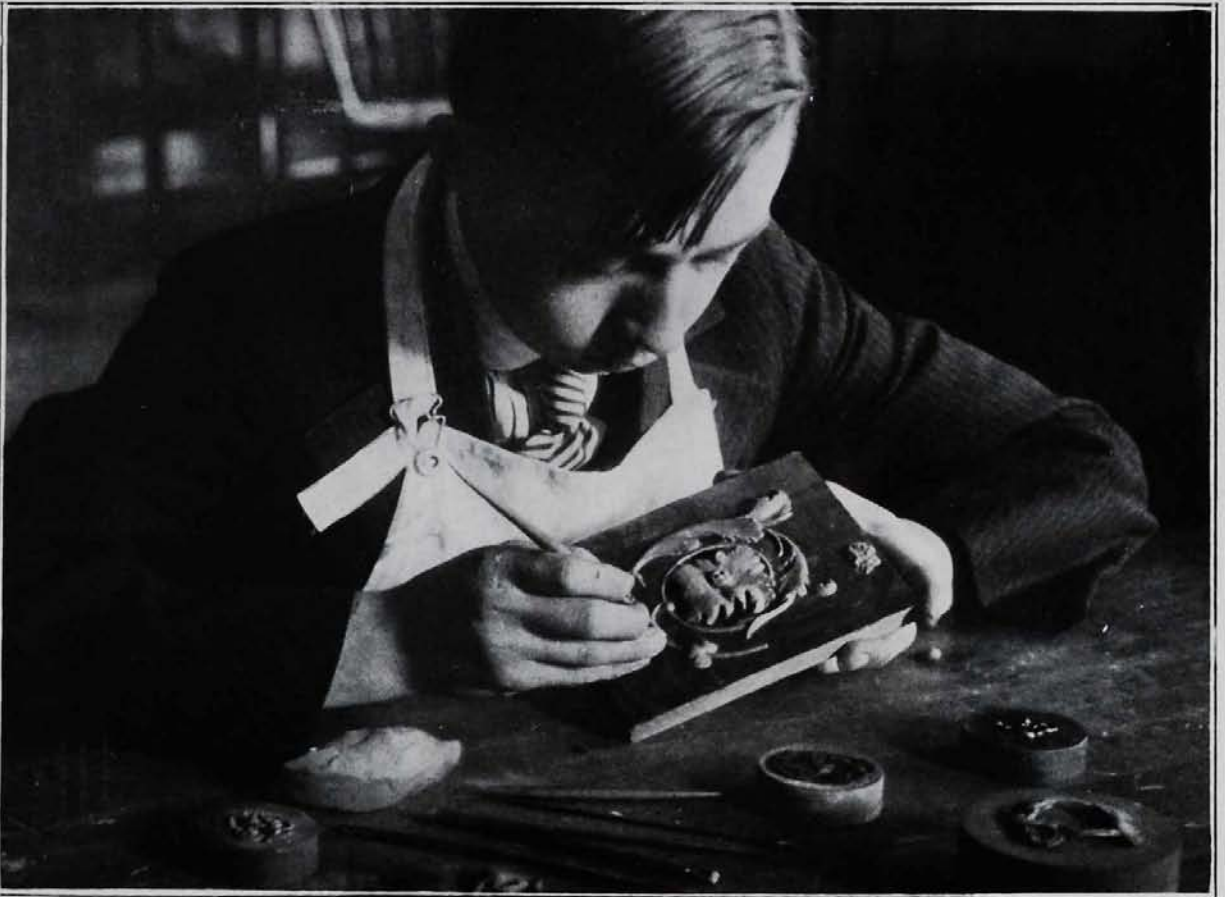
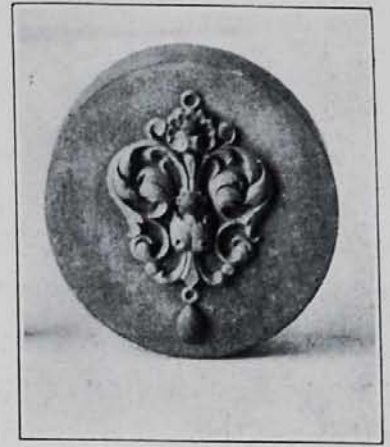


FIGURE 127

[200]

MODELING

The art of modeling is directly opposed to that of carving. Carving deals with the cutting away of the material while modeling is the art of building up. Although the modeler may be able to add to, take from or change any part at pleasure, building up, not cutting away, is the proper method to attain a simple and direct style of modeling.



After collecting the various materials and tools needed the student is ready to begin. For the first piece select a cast of some good ornament. A white rather than a colored cast is preferable because the lights and shadows are more decided. It is wholly by the strength and shape of the shadows that the modeler is able to see and reproduce forms.

As a knowledge of drawing is absolutely necessary a certain amount of skill in drawing should be acquired before beginning modeling. This preliminary knowl-



FIGURE 128

edge of drawing, however, need not be extensive, but, as we shall see later, the greater the ability to draw the better will be the result.

The subject to begin with is a scroll belonging to the Renaissance period. This should first be placed in an advantageous position. Stand it as straight as possible without allowing any chance of its falling forward, and in a position where the light will come from the side and somewhat from the front. In such a position you will get strong sharp shadows.

With a soft pencil, sketch the model upon the board or slate, Fig. 125. Begin with the stem and be sure to have it the right shape before adding any leaf, as it is easier to see and correct the defect of a curve when there is nothing else to detract the eye from its sweep. If the spiral is not drawn correctly in the beginning, it will be almost impossible to correct it when the details are added around it. A piece of ornamental work is a disagreeable thing to look upon if the lines do not turn and join one another in a true and graceful way. Wherever the stem disappears the eye must follow it and find its continuation at the right place and direc-

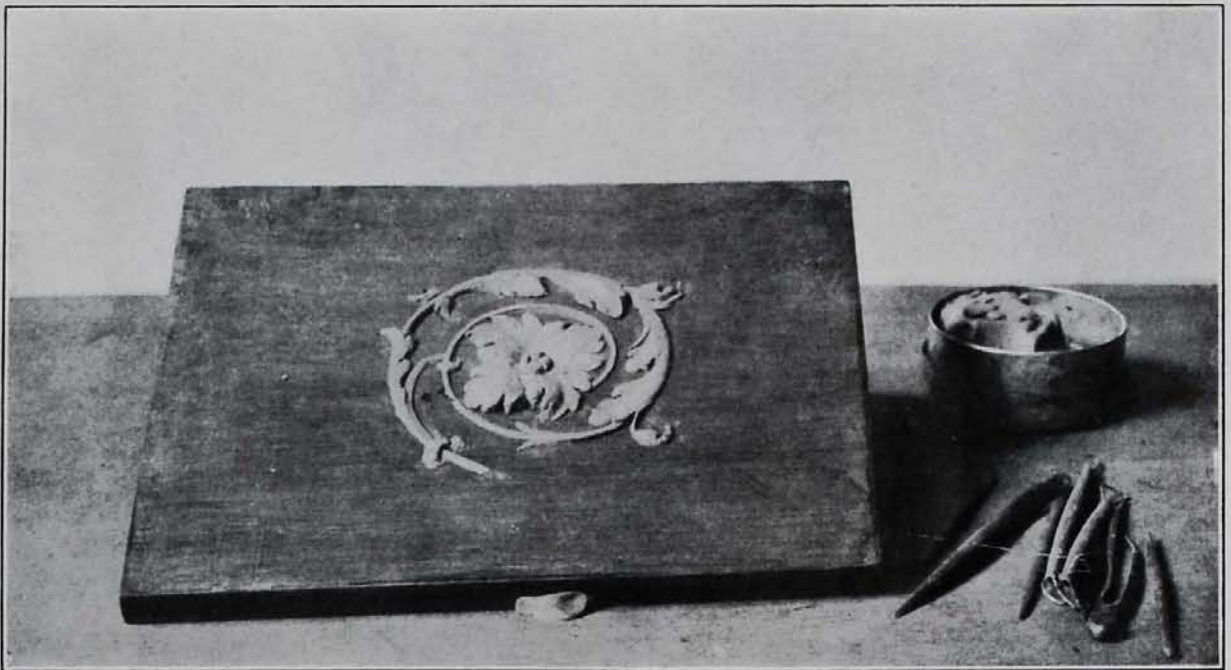
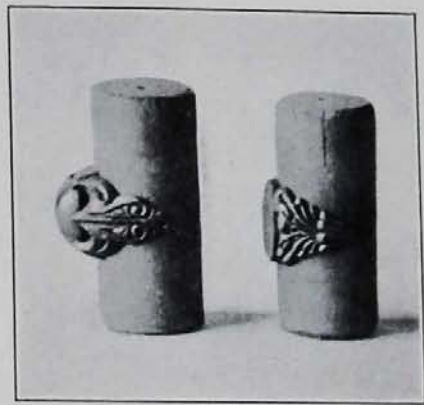


FIGURE 129

tion. When the stem has been drawn in a satisfactory way, sketch the details, leaves and rosette. This should be done in a broad and sketchy way, blocking them as if they were one big mass. After this has been done the details may then be brought out. The drawing may be done on paper and transferred to the board by the use of tracing or carbon paper.



The design now being on the board, we take some rather thick shellac and give it one coat. This when dry makes the plasteline adhere to it more readily.

Now take a lump of the plasteline, roll it between your hands in the shape of a cylinder and then put it on the bench and continue rolling it with the hand, bearing down hard enough so that the diameter is reduced and the length increased in proportion. With a little practice you can make a long string almost any length and size.

When the string of plasteline is of the right diameter put it on your board as on Fig. 128, having it follow the spiral in your design. Press it down slightly so that it sticks to the board, but be sure to have a good curve. When the stem is all done, start building up the leaves. Take small lumps of plasteline, roll them between your fingers and apply carefully to the board, inside the lines of your design. Do not go over, for as soon as you do so, you lose your outline and trouble begins. Keep adding little balls of plasteline until you have a fair imitation of your model. Go slowly and avoid putting too much on. Do not finish one part before starting another but carry your work along so that the same amount of work is put on every part of your modeling.

Remember that no amount of smoothing will make a poor form pleasing to the eye.

In the course of the work, do not be afraid to take your model in your hand and look at it from every angle. Holding your modeling in the same position will allow you to see if the curves are right, and by putting your modeling in the same light as your model and observing the shape and strength of the shadows, will help you to get the profile.

As practice makes perfect, repeat this exercise many times.

CASTING

The modeling having been done in soft material is subject to many accidents so that it is advisable to transform it into a material more durable. A cast in plaster of paris will stand handling without injury.

All tools and materials should be gathered and kept close at hand, for during the casting process there is no time to attend to such things. After the casting



FIGURE 131



FIGURE 132

is completed the tools used should be thoroughly cleaned and arranged for the next work.

After the final touch has been given to the modeling, Fig. 129, the next step as shown in Fig. 131, is to put a strip of paper around the board to hold the plaster. This strip cut out of heavy wrapping paper should be wide enough to allow one-quarter of an inch as the thickness of the mold and this must be allowed at the highest part of the modeling. Before winding the paper around the board, it should be soaked in water which will prevent it from wrinkling and will also keep the plaster from leaking out. The ends of the paper should overlap about two inches. Sometimes a strip or roll of clay will serve the same purpose as the paper.

Now place a little oil in a saucer and with a soft brush go all over the board and modeling. This should



FIGURE 133

be done very lightly. If plasteline has been used the oil is not necessary.

We are now ready to mix the plaster. Take the bowl or pan and about as much water as would be needed to fill the space inside of the walls of the paper. Then take some plaster of paris in the hand and sift it through the fingers sprinkling it evenly over the surface of the water. The plaster will sink to the bottom of the bowl at first but enough should be added till it is about one-eighth of an inch from the top of the water. Now take the spoon and stir it well, keeping the spoon below the surface of the water to prevent the air from getting into the plaster.

The plaster is now a creamy substance. Take a soft brush, and after dipping it in the plaster, paint all over the modeling, being sure to get into every little corner and crevice. By blowing over the plaster now and then it will prevent air bubbles from forming.



FIGURE 134



FIGURE 135



FIGURE 136

When the modeling is thoroughly covered with a thin film of plaster take a spoonful of plaster and placing it in one corner it will spread over the modeling. This is repeated until the space is filled, Fig. 132. The board should be tapped on the table from time to time while the plaster is being added which helps it to settle evenly.

When the space has been filled to the top of the paper it is placed one side and the plaster allowed to set for about one-half hour when it will be ready to take apart.

Assuming that the plaster is hard we now take the knife and place it between the mould and the board as shown in Fig. 133, and separate the two. We now have in the plaster an exact reverse of the modeling.

You will notice that the edges on your modeling have dragged, due to undercuts—which must be fixed in the mould, as it is easy to understand that plaster, being a hard substance, will not give as the wax

did, and should these undercuts be allowed to remain, it would be impossible to separate the cast from the mould. The care you take in fixing these undercuts insures the success of your final casting.

With the small blade of a sharp penknife, go carefully all over your mould, removing these undercuts, changing them into nice smooth draughts so your cast will slip off the mould easily. When this is carefully done, take some soap and a rather large brush (a common painter's brush known as a sash tool, about three-quarters inch in diameter, will be found all right) and putting your soap in the bottom of a glass or bowl, pour a little water over it. Rub your brush on the soap till you get a soapy water with which you wash the mould, rubbing it all over and afterwards rinsing the foam out under the faucet. Now take the oil brush and dip it in the oil and oil the mould all over, then put it to soak in water until air bubbles cease coming out of it.

The mould now being ready, place a strip of paper around it as in preparing it for the making of the mould, mix your plaster as before and fill to the top of the paper. When filled and before it gets too hard, drive into the plaster at the top a piece of wire bent U-shape, which will serve as a hanger.

Let your plaster get hard, and after trimming up the edges, Fig. 134, separate the cast from the mould by first dipping in water—boiling water is preferable, as it seems to help the separation. If they do not come readily apart insert the knife between them and they will come apart as shown in Fig. 133.

If you have been very careful in fixing the draughts of your mould, your cast will come out perfect; if not, you will find some little parts chipped off, which can be fixed by mixing a little plaster and remodeling the broken parts with it when it begins to get stiff. Fig. 136. As for the air bubbles if any, force some of the plaster into them and a perfect reproduction of your modeling is the result.

After trimming the edges and allowing it to dry it is ready for use.

CUTTLE FISH

Cuttle fish is used in casting special pieces or parts of jewelry when a metal pattern is available. After facing off the soft surface of a piece of cuttle fish with a file, cut it to the required size with the small saw. As cuttle fish is very brittle it must be handled with great care. Place the pattern on the piece of cuttle fish, Fig. 137, and press it carefully until it is embedded. Lift off the pattern, Fig. 138, and we have a mould which shows every detail of the pattern. If a little fine graphite is powdered over the mould and the pattern again pressed into it better results are obtained, Fig. 139.

An opening, Fig. 140, into which the metal is poured, is made with a small knife. A small vent is made at one side for air. After completing the mould



FIGURE 137



FIGURE 138



FIGURE 139

[211]

another piece of cuttle fish is fitted over it and the two are fastened together with binding wire. Moulds may be made in this way for rings, Fig. 141, and good results obtained. When the mould is ready, the metal to be used is placed in a crucible and melted. A little powdered charcoal is added to cover the metal in order to keep the air from it until it is ready to pour.

If scrap metal and filings are used, a little powdered borax is also added to help it fuse. If the crucible is small, it can be heated with the blow pipe if a melting furnace is not at hand. As it takes considerable time to get the metal ready it is advisable to have several moulds ready for pouring at the same time. The moulds are placed in a convenient position over a piece of sheet iron or tray to catch metal that is likely to run over. When everything is ready the crucible is lifted with a pair of tongs and the pouring is done as shown in Fig. 142.



FIGURE 140



FIGURE 141

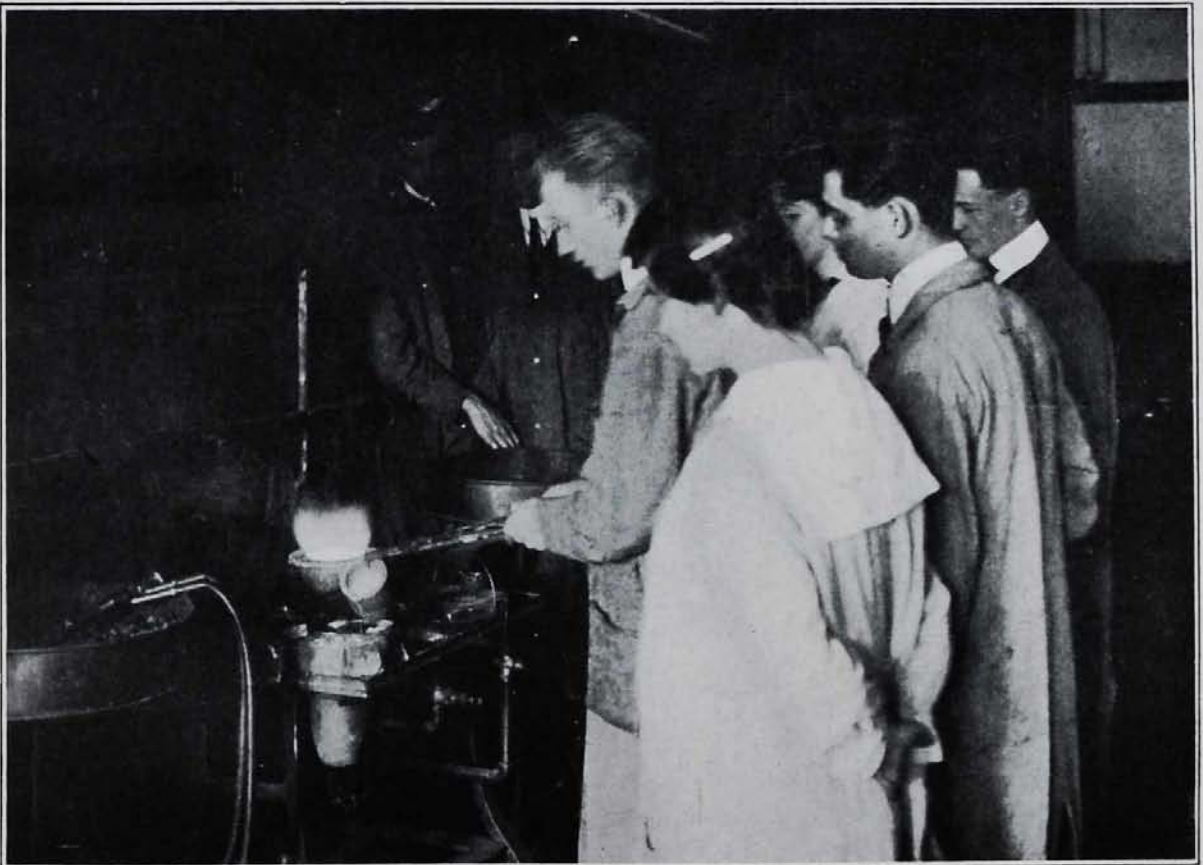


FIGURE 142

Chapter XIX
Hub and Die Cutting

ITS RELATION TO THE JEWELRY INDUSTRY

THE greatest aid to the manufacturing of all classes of jewelry is the steel die. To most manufacturing jewelers and kindred trades the die is absolutely indispensable, for this alone makes possible the production of large quantities of jewelry in a comparatively short time at a minimum cost.

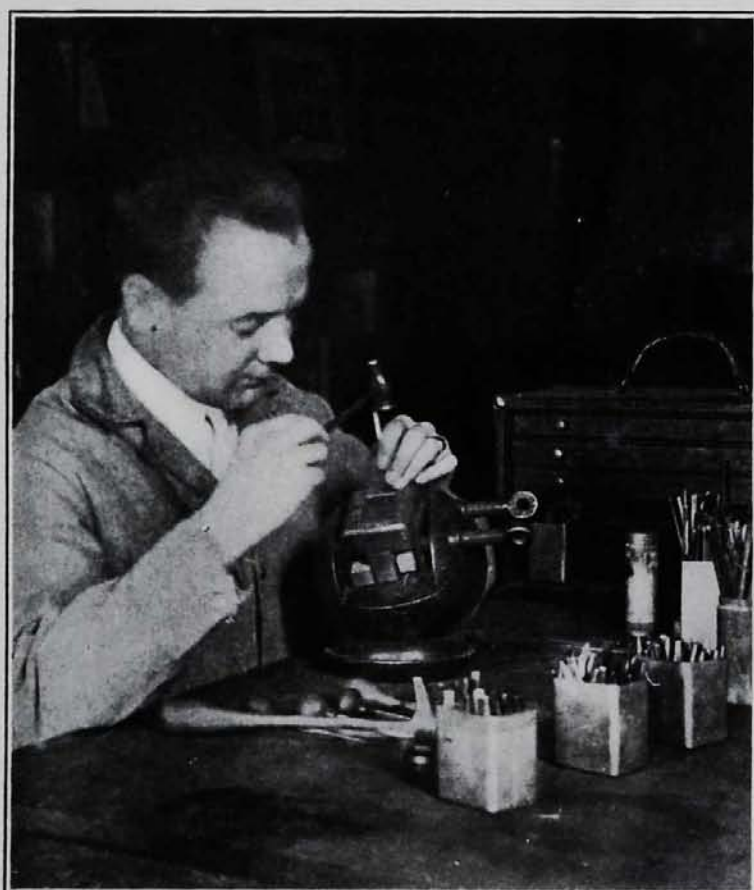


FIGURE 143

Pieces of jewelry are often stamped almost in their entirety or in some cases stamped in several sections and then assembled by hand. Beautiful designs and

effects are produced in this manner that closely rival hand wrought and most costly jewelry.

It has been truthfully said that this method of production brought decorative and useful jewelry within the reach of all.

THE HUB

WHAT IT IS AND HOW APPLIED

The hub is a positive form or a perfect model in steel of the design to be produced. It might also be termed the accessory before the fact. The only use to which the hub is put is to produce the die or negative form, from which the object is stamped in any of the softer metals.

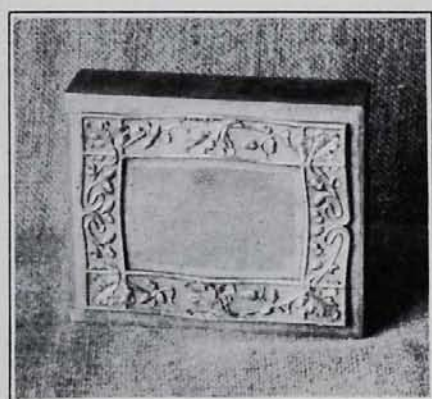


FIGURE 144

When the hub has been cut into the desired form it is hardened and tempered and then by means of the drop-press it is driven into a larger piece of steel called the die. In some classes of work the hub must be used, in others it is non-essential or a waste of labor.

The student should study carefully this point, for large sums of money are spent needlessly by manufacturers for no other reason than that they do not understand the technique of hub and die cutting.

THE DIE

WHAT IS IT AND HOW APPLIED

The die is a negative form produced as described above or by cutting direct by hand.

The class of work usually cut in the die are those designs that do not call for flat bright surfaces or perfectly symmetrical outlines, or outlines that must fit accurately to some other form or space, or chased and engraved effects.

HARDENING CUTTING TOOLS

Heat tools to a "cherry red" in a forge or with a gas blow pipe and then plunge into cold water. Test with a file and if the file will not cut, polish tool with emery cloth and then temper by drawing tool through blow pipe flame slowly until steel turns to a light straw color, then plunge into water.

If the cutting edge will not stand a reasonable amount of use, but does not break, it is too soft. Re-harden and temper very lightly. If the cutting edge breaks or crumbles it is too hard; polish and retemper lightly. Avoid a "white heat" in hardening as it burns and spoils the steel.

SHARPENING TOOLS

To sharpen or shape the ends of chisels or engraving tools grind on a wet grindstone. If an emery wheel is used great care must be taken to avoid friction heat that is sufficient to discolor the steel. Should it discolor grind off the discolored part or re-harden and temper.

At such times as the tools need only a little sharpening, use a well oiled India stone.

STEEL USED FOR HUBS AND DIES

Jessop's and "Crescent Special" tool steel are nearly always used for hubs and dies.

MEASUREMENTS OF STEEL

Hubs: Allow one-eighth of an inch margin all around the design for average work, but for work having large flat surfaces or for designs to be deeply cut allow one-quarter inch margin.

The depth or thickness of a hub should be about one inch for small work and one and one-quarter or one and one-half inches for large work.

Dies: Small dies that are cut by hand require not less than three-eighths of an inch margin. Large

or deeply cut work requires a margin of one-half to one and one-half inches.

Dies made by the hub process should have a margin all around the design from one-half to one and one-half inches. In other words, the margin should be sufficient to prevent the steel from displacing or spreading from the hub outline when the hub is driven into the die.

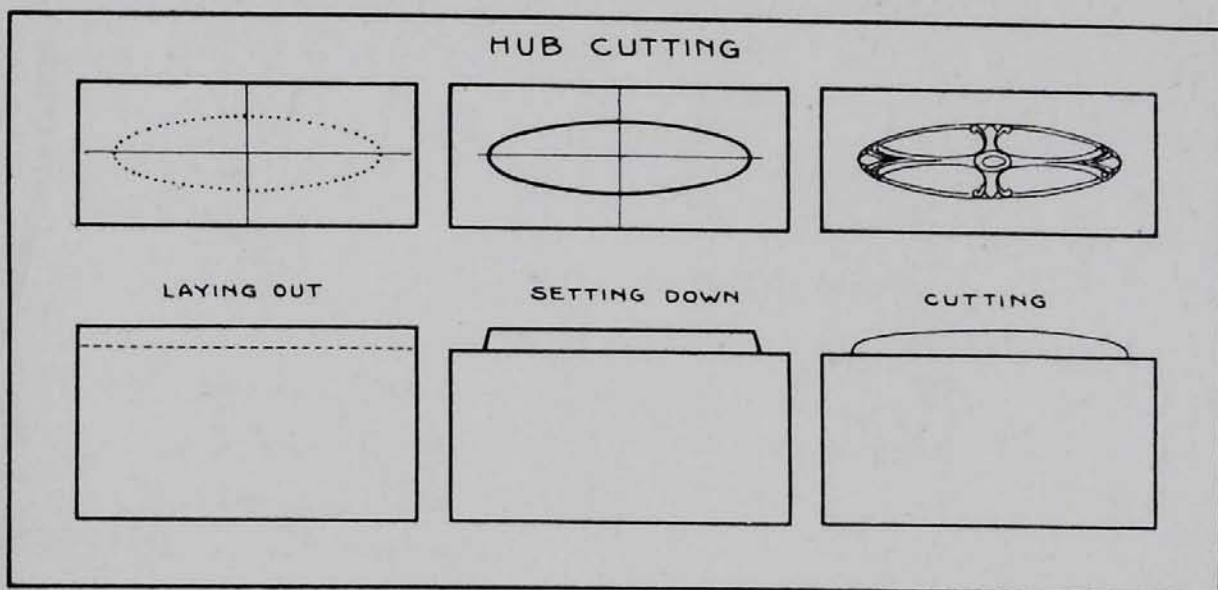


FIGURE 145

METHOD OF LAYING OUT AND CUTTING HUBS

Hubs: First be sure that the top and bottom of hub is flat and absolutely parallel. Make top surface smooth by grinding or draw-filing and then polishing with fine emery cloth. Next color steel by applying a solution made as follows: To four ounces of water add and dissolve enough blue vitriol crystals to turn the water a brilliant blue, then add a teaspoonful each of nitric and muriatic acid. As soon as steel turns copper color wipe off excess moisture.

With dividers find the center of the longest way of the hub and lightly mark it near the ends. Then with scratch-awl and hammer lightly punch holes as near edge as possible. Place one point of dividers in one of these holes and scribe section of circle that

will mark the middle of the hub at the edge. Then repeat this action at other end of hub and where these sections of circles cross, punch with scratch-awl as before.

Lay scale on hub and with scratch-awl firmly scratch lines from punch-hole to punch-hole. This gives center lines across the hub that are at perfect right angles.

Never scratch center lines by running dividers along edge of hub.

If design is composed of only straight lines or circles lay it out on hub mechanically with dividers, scale and scratch-awl.

Other designs should be laid out in the following manner: cut piece of tracing paper a little smaller than top surface of the hub and fold and crease it to form right-angle lines through the center as on hub; cut small v at four edges of paper on center creases. Lay tracing paper over drawing or design and center it, then trace with sharp soft pencil (according to repeat of design) one-half or one-quarter of the design; complete the tracing by folding the tracing paper in such a manner as to be able to draw the other sections from the first.

Place tracing paper upon hub so that the v's in edges of the tracing paper center on scratch lines on hub and stick down with beeswax. With scratch-awl and hammer follow the center of pencil lines and punch a dotted line through tracing paper.

When paper is removed the design is evident in the form of finely dotted lines. Dot the lines only heavy enough to be plainly seen.

The hub is then ready for "setting down" or removing the steel that forms the margin around the design. The depth that a hub is "set down" is governed by the depth of the modeling the design requires. The average hub should be "set down" about 1-32 of an inch deeper than the modeling or relief of the design.

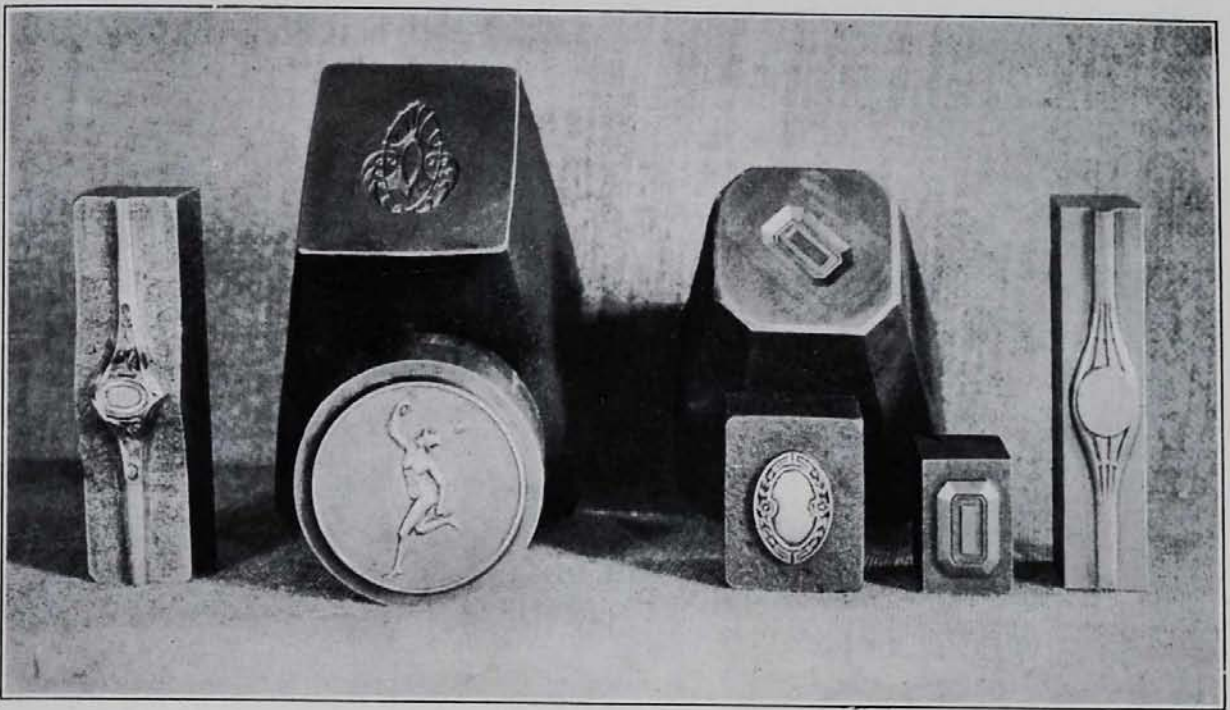


FIGURE 146

When the depth is determined scratch deeply a line around the sides of the hub at the desired depth, measuring from the top or face of the hub. Scratch this line with a surface gauge if possible or with dividers by catching one end of dividers against the top edge of hub.

The student just beginning would do well to cut away the margin steel from hub with chisel and hammer to obtain the very necessary practice with these tools. When more advanced it should be removed with drilling, planing or milling machines.

When the outline of the design has been "set down", Fig. 145, as evenly as possible with the eye, it should then be perfected by the use of a gauge.

Take a piece of sheet zinc $\frac{1}{2}$ -inch larger all around than the design and place against the face of the hub and then place piece of wood or lead upon the zinc and squeeze tightly in a vise.

This marks the outline of the design on the zinc, the center of which should be sawn and filed out so that it will fit the hub like a collar. Then take small

flat punch and hammer and "up set" or tap the zinc in so that it fits tightly. Now mark one end of hub and zinc so as to know the first position of the gauge.

Lift off gauge and reverse it on hub. It will be found that it will not fit very well in this position, so take file and lightly file places where it binds. Do not force gauge down but work carefully until it goes down as it did in first position.

Then turn gauge over and fit in two more positions as above, that is if design has four equal quarters. In the last position "up set" gauge with punch as before and fit again all around. If carefully done this will give a perfect outline.

The next step is to consider the general form that the hub is to assume and the depth of modeling.

Re-color the entire top of hub with vitriol and then with surface gauge or dividers mark depth of modeling around the sides of part of hub that has been fitted to gauge.

With chisel or file rough out the general elevations or planes and leave them fairly smooth. Re-color and scratch center lines upon modeled section and from these lines lay out detail of design. Mark out principal points with dividers and scale, if possible sketch in balance of design with scratch-awl or use tracing paper.

With small ongette graver lightly line in details of design and then model or cut away as much as possible with chisels.

True and smooth the modeling with engraving tools and when satisfied no more can be done with these tools use riffels, Fig. 151, to finish.

Perhaps the use of hardened steel punches made into several shapes that will fit into details of modeling may be used to advantage in truing hollow lines or cuts, or for matting surfaces.

The use of these tools is governed by details of design and should be used with care so as not to displace the steel.

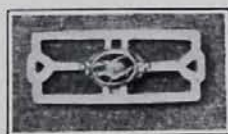
Use pencil oil-stone to remove all scratches or ruffle marks from bright surfaces and sides, or any steep angles in the modeling. A very high polish is obtained by polishing with flour of emery applied with oil upon wooden sticks or leather.

Hubs for designs having piercings: Prepare hub and "lay out" the same as directed above. When "setting down" drill out places for piercings to same depths as the outside margin. Use drills that are 1-64 of an inch smaller all around than outline of piercing.

With scratch-awl and hammer make punch mark in center of piercing to insure the drills starting in correct place.

Make and fit gauge for outline of design as for plain hubs, after which cut out piercings with chisels. Begin with pointed chisel and cut from corners of piercing into drill holes, remove as much steel as possible with chisels and then true lines with gravers. Now continue as for non-pierced hub.

All vertical lines of hubs should be slightly beveled, or a fraction smaller at the top than at the base of the modeled portion. A hub undercut or smaller at the base than at the top is useless.



DIE CUTTING

To lay out a die that is to be cut by hand, prepare top surface in same manner as for hubs, also find and scratch in rectangular center lines. If possible lay out design mechanically with dividers and scale, or use tracing paper. At times both methods combined may be used to advantage.

When dotted lines are made from tracing paper a little plaster of paris or chalk rubbed in the holes with the fingers makes the design more easily seen.

With small ongette graver lightly line in design. Firmly fix in the mind that a die is a negative form and that its treatment is the reverse of the hub in all details except the laying out.

It would be well for the student to copy a piece of jewelry or a model in cutting the first few dies as it

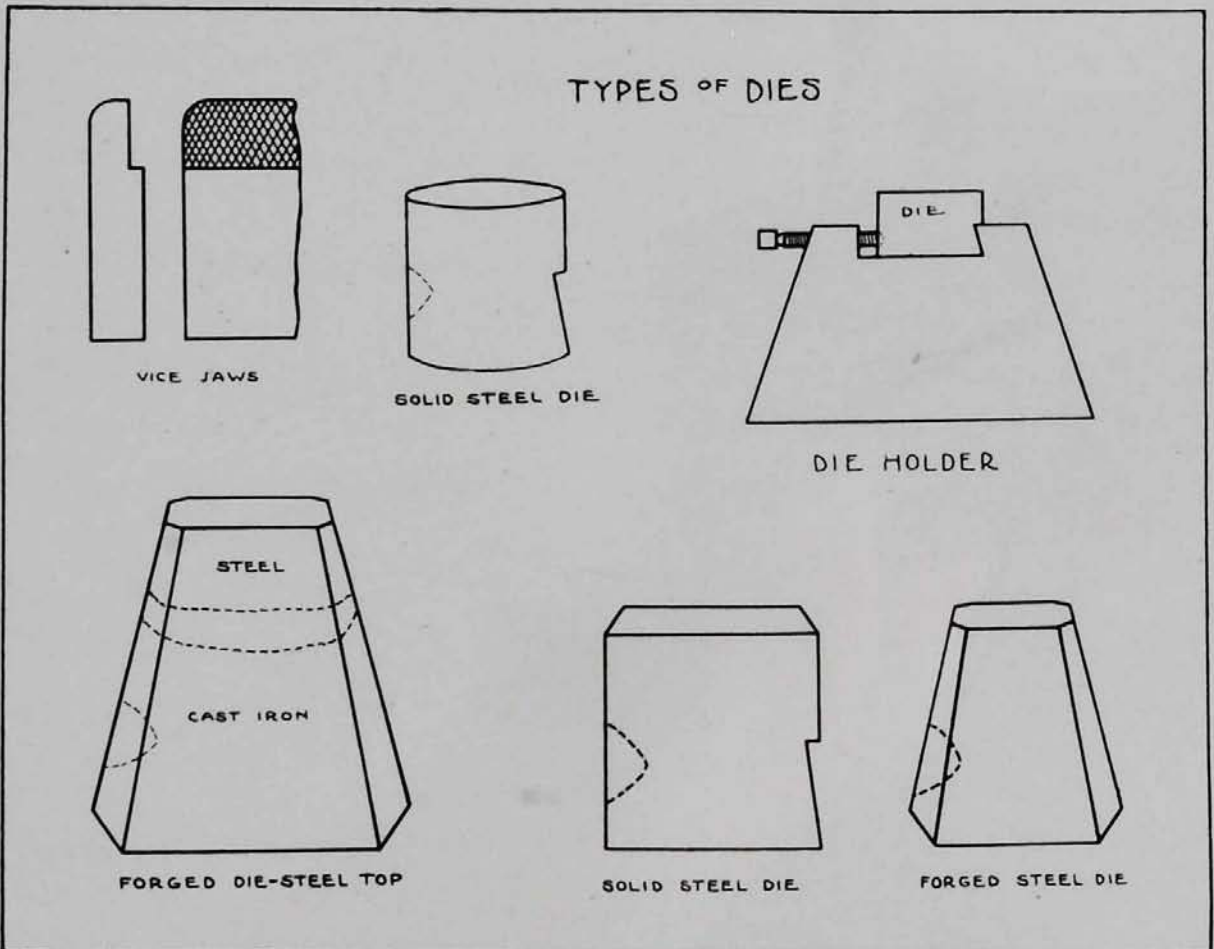


FIGURE 147

will be less confusing. Dies for designs without piercings should be cut into general form first with chisels, gravers and raffles. Re-color with vitriol and then lay out details of design and proceed to cut out deepest parts with chisels. True and smooth with gravers and then cut in shallow details with gravers.

Lines or surfaces may also be trued or set with punches of necessary form. Avoid as far as possible the displacing of the steel with these tools. Fine raffle where necessary and then polish as for hubs.

Dies with piercings should be laid out in full detail of outline in any of the above methods. Cut out steel with chisels as near to outline as possible without taking out lines. True to line with gravers and then proceed as for other dies.

Care should be used to keep the portion of the die forming piercings on the same level with the margin of the die. Use the greatest care to avoid undercutting or rough side surfaces.

The sides or edges of cutting should have enough bevel and be smooth enough so that when the metal is stamped into the die it will leave the die freely. Have small piece of modeling material on block of wood and use to tap into die to procure impression of cutting.

Before polishing die stamp piece of lead into it with drop-press, if the depth and details are satisfactory, then polish; after polishing stamp lead in again to make sure that it will leave the die freely before hardening.

A general knowledge of other branches of the jewelry trade, particularly tool-making, will help the hub and die cutter to work more intelligently.

HARDENING

The charcoal fire in a forge is the usual and most satisfactory method of hardening hubs and dies. This heat is easily controlled. The gas furnace may also be used but the uttermost care should be exercised to

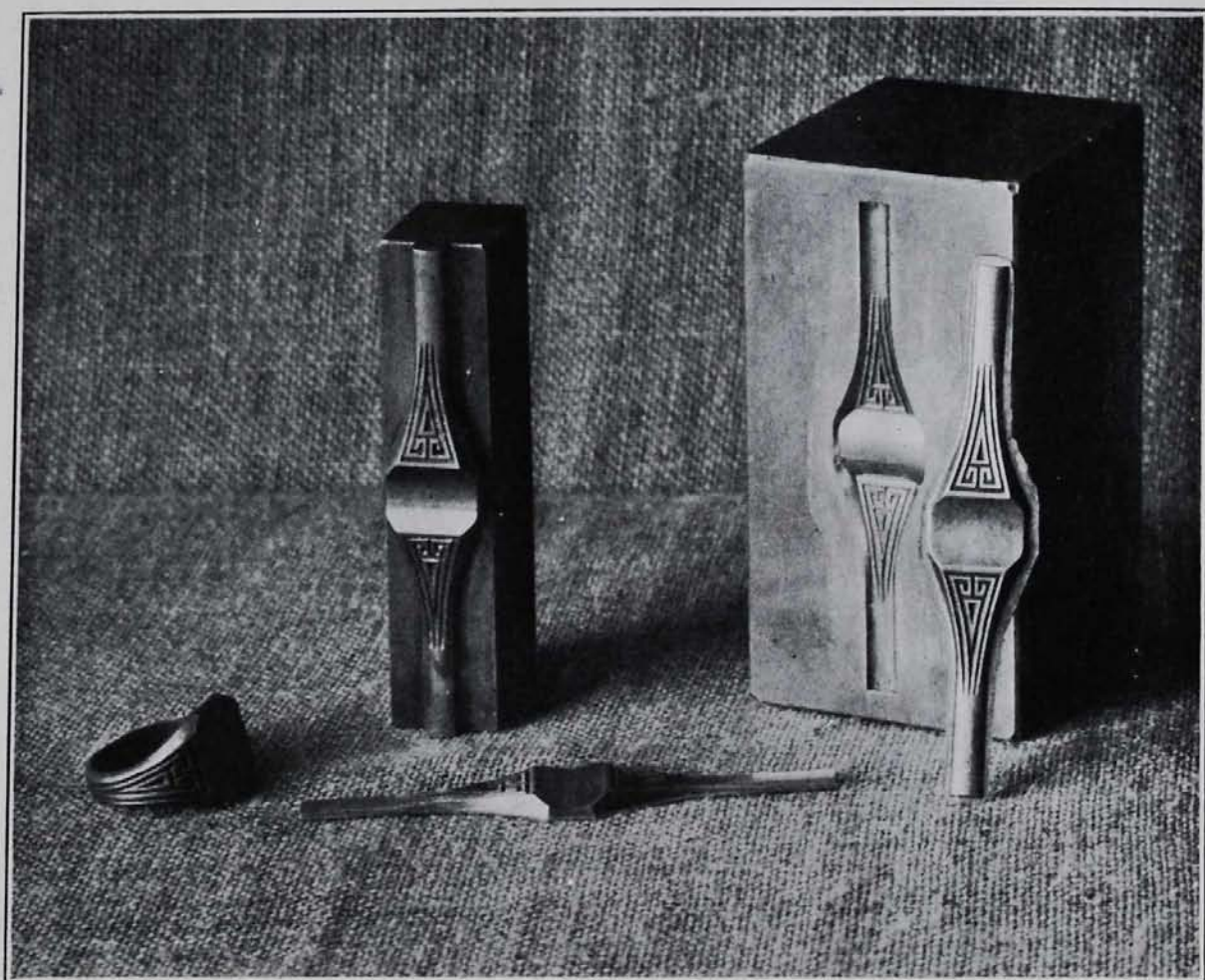


FIGURE 148

avoid overheating. The average gas furnace gives a most intense heat which requires considerable experience to handle properly.

The most advanced and scientific hardening is done with the type of gas furnace that is used in conjunction with a lead bath equipped with electric heat indicator.

Mix enough machine or lard-oil with lamp-black to make a thick paste. Apply a thick layer of this to the top surface of the hub or die before placing in the fire. This prevents the finished parts from blistering or scaling. Heat hubs until they are of a clear heat right through but never to a shiny or white heat. When taking from fire grip firmly with tongs and quickly plunge into cold water.

If hardening in "still water" move back and forth well under surface of water; if in running water, hold under the inflow. Do not remove from water until cold.

Place on fire again and heat enough so that water will boil upon it and then pour muriatic acid upon it and allow the acid to remain about half a minute, then wash in water. Test with file and if the file will not cut it, it is ready to have the top surface polished with fine emery and oil.

If hardening with charcoal fire, place hub on fire without wind blast on. Turn hub from time to time until steel turns to light straw color, then plunge into water.

If hardening with gas furnace, temper by setting hub on a larger piece of red hot steel or iron, turn about until coloring begins and then plunge.

Always place hub or dies face up in the fire. Dies should always be hardened in running water in a large pan, bucket or barrel. Heat dies to same heat as for hubs. When plunging hold face die under inflow of water until perfectly cold.

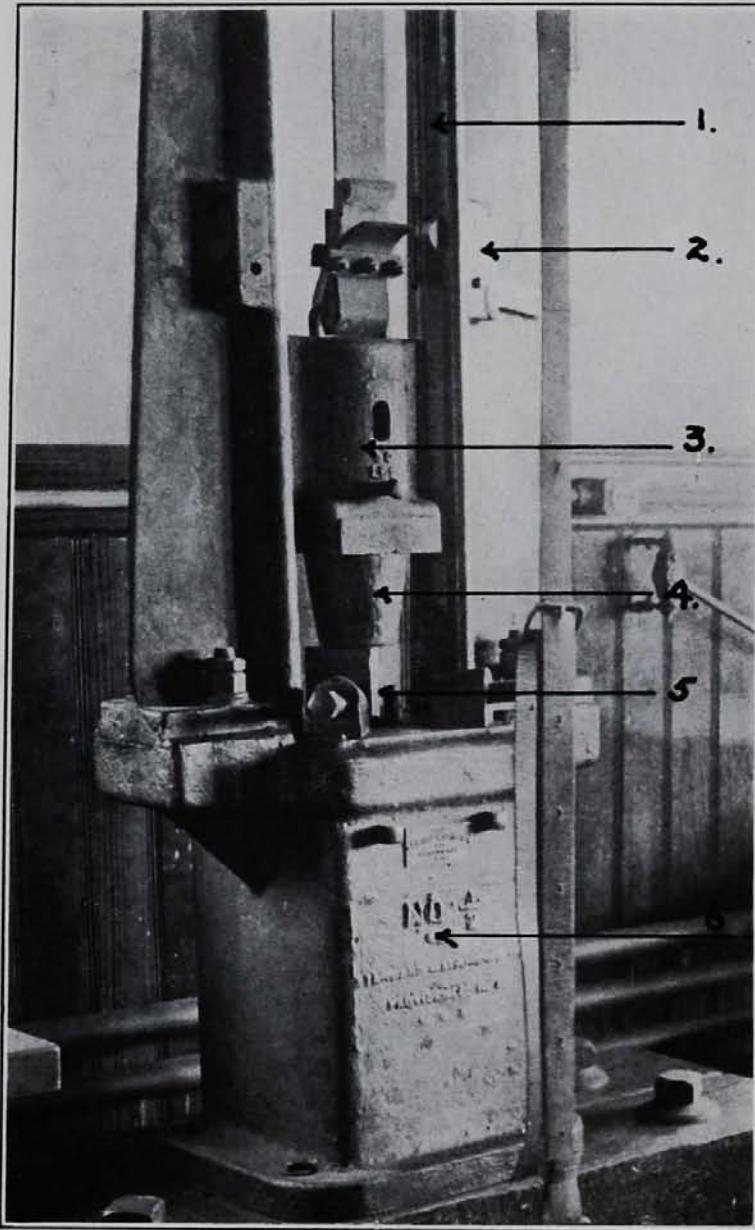
Place in fire again until hot enough to boil water upon it, then apply muriatic acid, test with file and polish. Place upon fire and turn around occasionally until it turns a light straw color, then plunge into water.

Do not try to hurry the tempering, for if a forced fire is used the die will temper too rapidly on the outside and be too hard in the center.

Most manufacturers use one or sometimes two types of dies; the hub or die cutter must be governed by this fact in the types of dies he uses.

DRIVING HUBS INTO DIES

The common method of driving hubs into dies is by means of the drop-press, but for the larger class of work the hydraulic press is used.



1. Runners
2. Safety catch
3. Hammer
4. Jack
5. Die and set screws
6. Bed

FIGURE 148-A

To drive a hub that has no piercings and is of average depth of modeling: first select a die with a flat top and plane or file off not less than 1-32 of an inch, then draw-file surface with fine file and polish with fine emery cloth, color surface with vitriol and then place hub upon it in the center and mark around it with pencil or scratch-awl. With the corner of an

emery wheel cut a nick in one of the edges of the back of the hub, also on the edge of face of die. These are called "front marks" and are used to insure the placing of the hub and die in the same position each time it is set up in the drop-press.

Screw the die into position in drop-press if of the tall steel topped type, but if smaller solid steel die is used set die into die-dish or holder made to fit this type of die. Then place hub face to face with die in position marked on die. If the hub is of such shape that it will set flat upon die it is ready for a blow from the hammer of drop-press. If the hub is of such shape that will not set flat, place a thin layer of wax on the back of the hub and lower the hammer until it rests upon the hub. When the hammer is raised the hub sticks to the jack or lower part of the hammer. Raise hammer about halfway up and let fall, using great care not to let the hammer rebound or strike more than once.

This first blow will give an idea as to how hard the second or other blows may be delivered.

Now stamp lead into the die and compare it with hub and if it is deep enough and shows all the details of the hub, file off face of die so that all edges of sunken part are of same depth, then use oil-stone to polish rough edges.

The bottom of the die should then be turned off so that it is parallel with the face or top. About an inch in the center of the bottom of the die should be turned 1-32 of an inch deeper than the outer part of surface. The die is then ready to harden.

To drive a hub having piercings it may be treated as for plain hub if of shallow modeling, but if deeply modeled and having many or very small piercings the top of the die should be domed or rounded on the top.

To drive a hub into a red-hot die, first place die in position in drop-press, then wax back of hub, and place, holding hub upon die, lower hammer until it rests firm-

ly and the hub sticks to jack. Raise hammer enough to clear die and then center die to hub by adjusting die with screws of drop-press. Next raise hammer and make it fast with safety catch, loosen two front screws of drop-press and remove die and place in fire upside down. Heat to a dark red and then place die in position again and screw up front screws.

Have pan of water near, also a stiff bristle brush; dip brush into water and then quickly splash and brush top of die; this removes the scale from die that forms with the heating.

Raise hammer and let it fall. Hold hammer up with safety catch and quickly pick up hub and drop it into pan of water. This keeps the hub cool so that it may be handled and also keeps the temper from being drawn from the hub by the heat.

To strike a second or more blows splash water into die with brush and then place hub into die with the hand and strike hub again as quickly as possible. If necessary heat die a second time and continue as before until hub is driven to desired depth.

If hub should stick in die when driving, strike with small hammer on side of hub to knock it out.

Allow die to cool slowly.

Clean out die with acid as when hardening and then face off top of die with file or by turning in lathe so that edges of sunken part are of even depth. Polish out die and then lightly strike hub into die again with drop-press with the die cold.

Draw-file the top of die and stone edges. Turn off bottom of die and harden and temper.

THE FORCE

The force is a positive form that is fastened to the jack of the drop-press to help force the gold, silver or brass into the die.

For nearly all shallow dies the flat force is used. This in shape follows the outline of die but is about

1-8 of an inch larger all around and is set down about 1-8 of an inch. The surface is plain and flat.

For very deep dies or when it is desirable to have the piece of jewelry very thin or light in weight a force is used that conforms to the die in detail. Such a force closely resembles a hub, but does not have such finish as a hub. The force is hardened also.

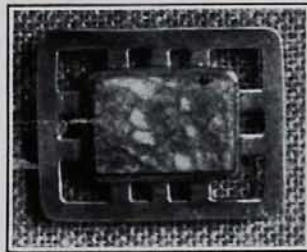
STAMPING

The die and force are very carefully adjusted in the drop-press so that the force centers over the die. The metal that is to be used for stamping is cut into pieces a little larger than the sunken portion of the die and this is placed squarely in the center of the die. The hammer is then allowed to strike one blow.

Small or shallow designs are usually stamped with one blow; if necessary to strike more than one blow to get the piece up sharply, the stamping should be annealed after each blow.

A good general knowledge of all branches of the jewelry trade will greatly help the hub and die cutter. Particular attention should be given designing and modeling.

In addition to the broad field offered to the hub and die cutter in the jewelry trade there are other very interesting fields such as offered by the silversmithing trade, embossing of leather, paper, cloths and silks.



EQUIPMENT FOR HUB AND DIE CUTTING



FIGURE 149

THE DIE BALL AND RING

The die ball should be from fifteen to twenty pounds in weight or heavy enough to withstand the vibration of deep cutting with hammer and chisel. It should be fitted with at least two substantial screws to hold the hub or die firmly.

The pad or ring used to hold the die ball in position should be of leather with a hole in the center and filled with sand, or a ring made of three thicknesses of two-inch belting riveted together. It should fit the ball firmly but allow it to revolve freely.

VICE JAWS

Vice jaws are used to hold hubs in conjunction with the die ball and should be about $\frac{1}{2}$ by 2 by $3\frac{1}{2}$ inches in size. One side of each jaw should be machined out to form a shelf 1-8 inch wide and one inch deep. The vertical surface must be made very rough by grooving or punching. If made of tool steel harden and temper, if of machine steel case harden.

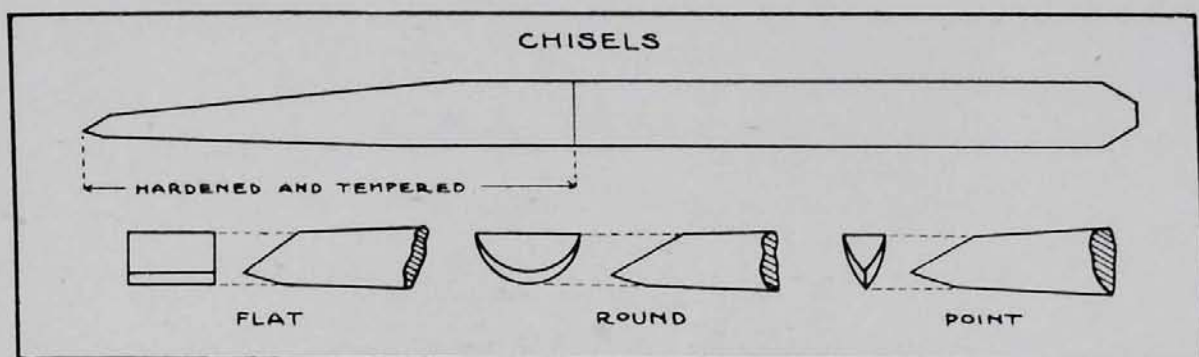


FIGURE 150

CHISELS

One dozen chisels are sufficient for a beginning and the supply may be enlarged as occasion demands. Six inches is a good length and must be made of a high grade tool steel. Select first dozen as follows:—

Flat shape—widths 1-16, 3-32, 1-8, 5-32, 3-16 of an inch.

Round shape—widths 1-16, 3-32, 1-8, 5-32, 3-16 of an inch.

Also two pointed chisels 3-32 and 5-32 of an inch at the widest part of the cutting end.

These tools may be bought at hardware stores that carry jewelers supplies, but it is advisable to learn to make chisels if possible.

GRAVERS

The following engraving tools are necessary for average work. Flat shape—sizes 38, 40, 42, 44, 46. Round shape—sizes 50, 53, 56, 58, 60. Onglette shape—sizes 2, 6. Numbers given are for Vautier gravers.

New gravers are improved by cutting off about one-half inch from the upper end before fitting handles. Very short handles are best. To avoid splitting handles, drill hole for tools position.

RIFFLES

Types of ruffles required are termed “Die Sinkers Ruffles” and “Medium Ruffles.” Very fine cut ruffles

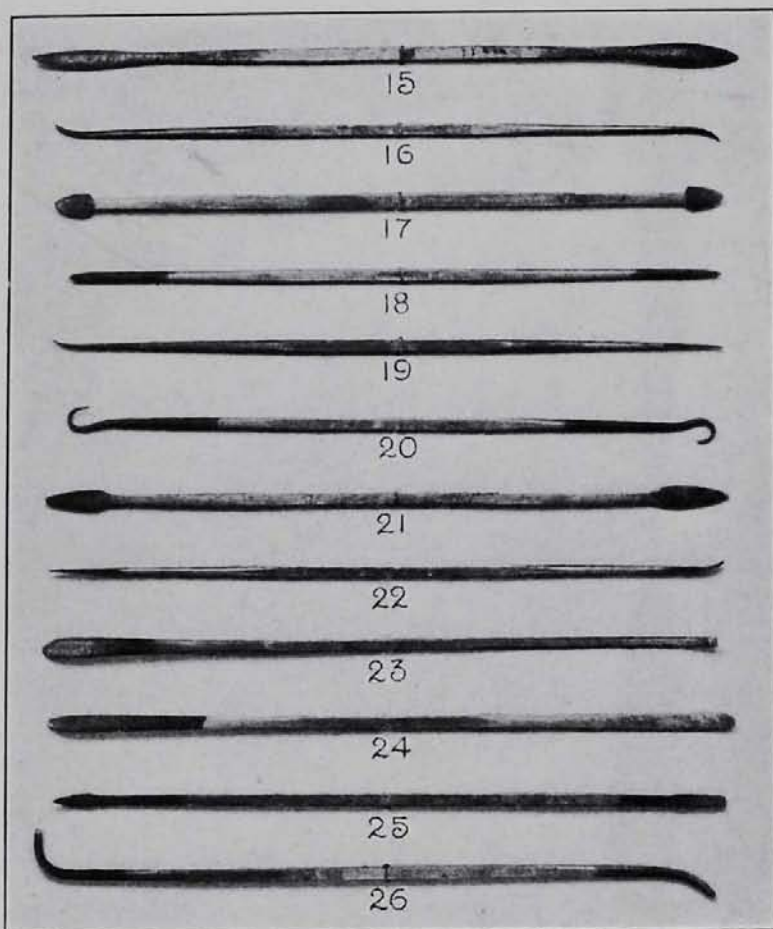


FIGURE 151

should be avoided as they clog or fill up so easily that they are nearly useless.

These tools should be rough enough to cut freely and quickly. Six of these tools are sufficient for beginning and should be increased as the need is felt.

FILES

Three files are essential. One should be a coarse cut twelve or fourteen inches in length, the second a six-inch file of medium cut and the third a narrow six-inch file of fine cut.

HAMMERS

The Stubbs hammer is the most desirable type, and size 21 meets the average demand.

OIL STONES

The medium grade India Oil Stone size 1 x 2 x 8 inches is desirable for sharpening tools.

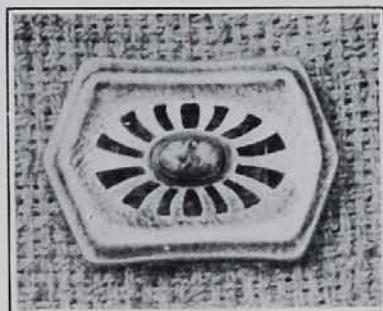
An India and an Arkansas stone $\frac{1}{4} \times \frac{1}{4} \times 4$ inches in size, also an Arkansas pencil stone should be used in finishing hubs and dies.

DIVIDERS, STEEL SCALE, SCRATCH-AWL

A pair of steel dividers about three and one-half inches in length will be found the most handy size.

The steel scale should be thin and flexible, six inches in length and divided into thirty-seconds and sixty-fourths of an inch.

A small round file cut off to three and one-half inches in length and ground to a very sharp point makes a good scratch-awl, or use one-eighth round steel and harden and temper point.



Chapter XX

Equipment

WORK in jewelry is being introduced into schools all over the country. It is hoped that the plans for rooms and the equipment outlined and illustrated in this chapter will be of help to those who are about to start work of this nature.

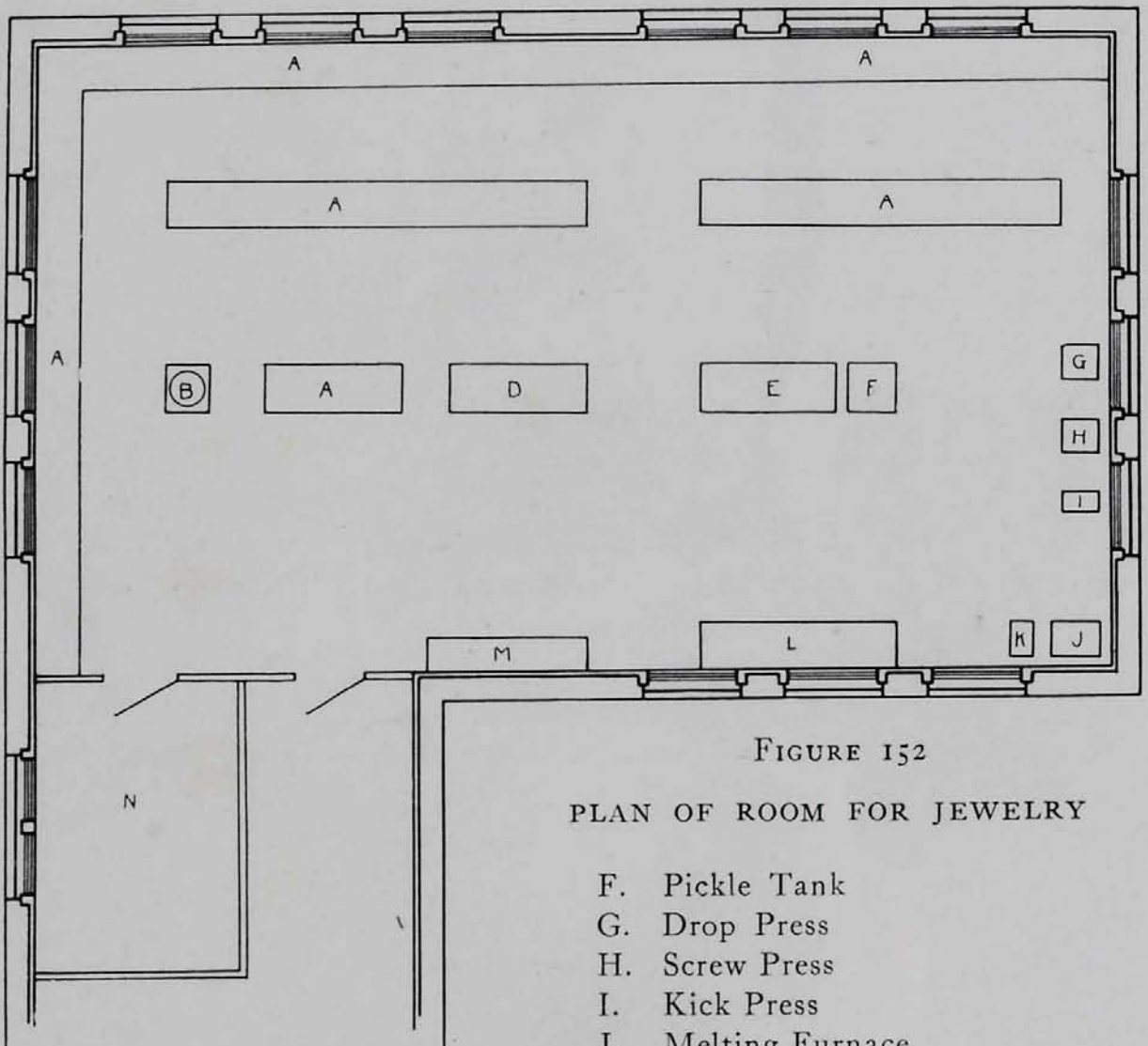


FIGURE 152

PLAN OF ROOM FOR JEWELRY

- A. Benches
- B. Drill
- D. Roll
- E. Sink

- F. Pickle Tank
- G. Drop Press
- H. Screw Press
- I. Kick Press
- J. Melting Furnace
- K. Enameling Furnace
- L. Polishing Bench
- M. Cabinet for Finished Work
- N. Teacher's Room

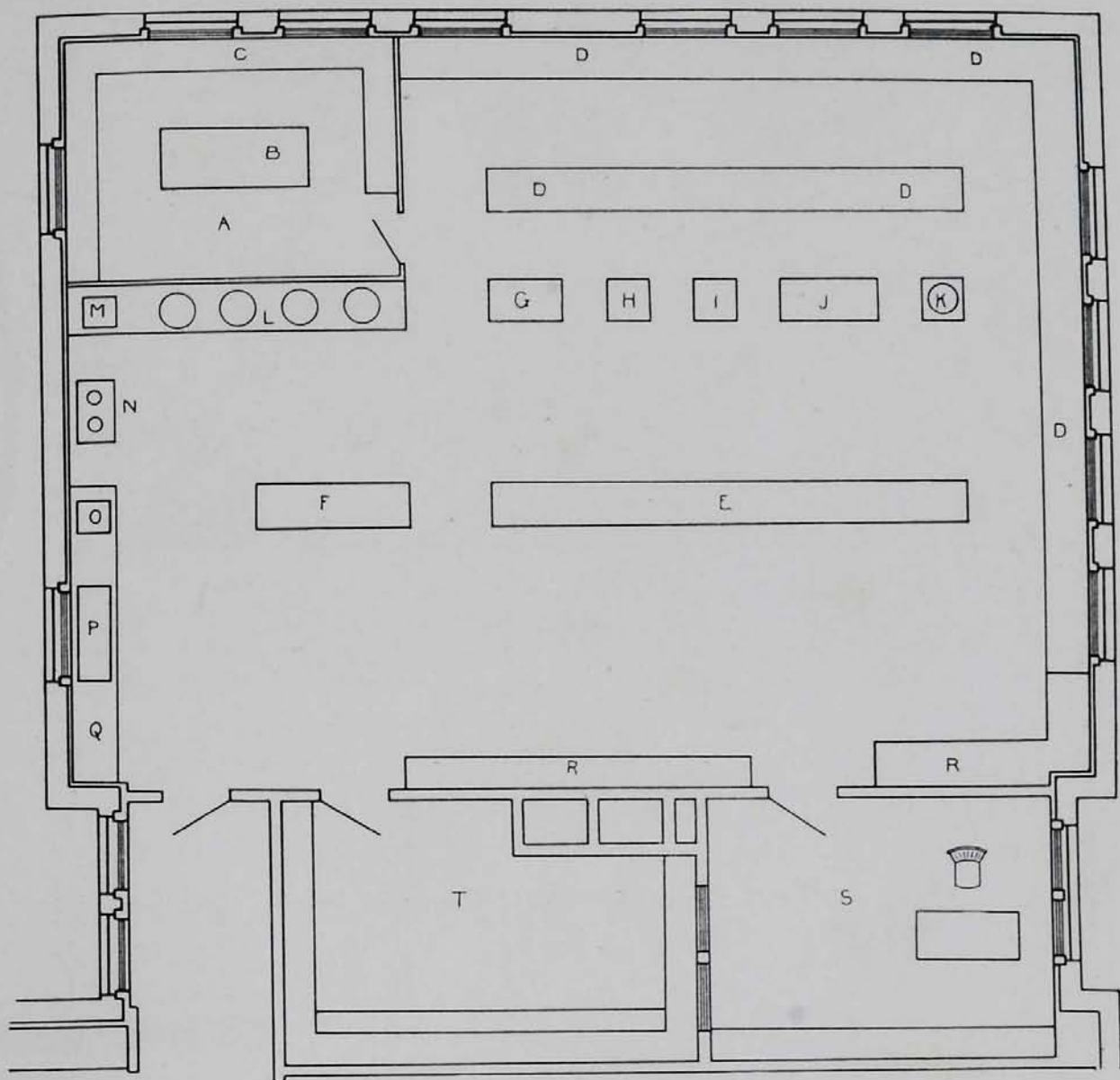


FIGURE 153

PLAN OF ROOM FOR JEWELRY

This plan shows the arrangement of benches and other equipment for work in Jewelry. The nature of the work requires good light which should come from three sides if possible. The type of bench shown on Plate LIII is used in this room.

KEY TO PLAN

- | | | | |
|----|---------------------|----|------------------------------|
| A. | Coloring Room | K. | Drill |
| B. | Sink | L. | Annealing and soldering pans |
| C. | Cabinet and Shelf | M. | Enameling Kiln |
| D. | Benches for Jewelry | N. | Melting Furnace |
| F. | Sawdust Box | O. | Pickle Tank |
| G. | Roll | P. | Sink |
| H. | Screw press | Q. | Bench for cleaning |
| I. | Kick Press | R. | Cabinet for finished work |
| J. | Polishing Bench | S. | Teacher's Room |
| | | T. | Storage Room |

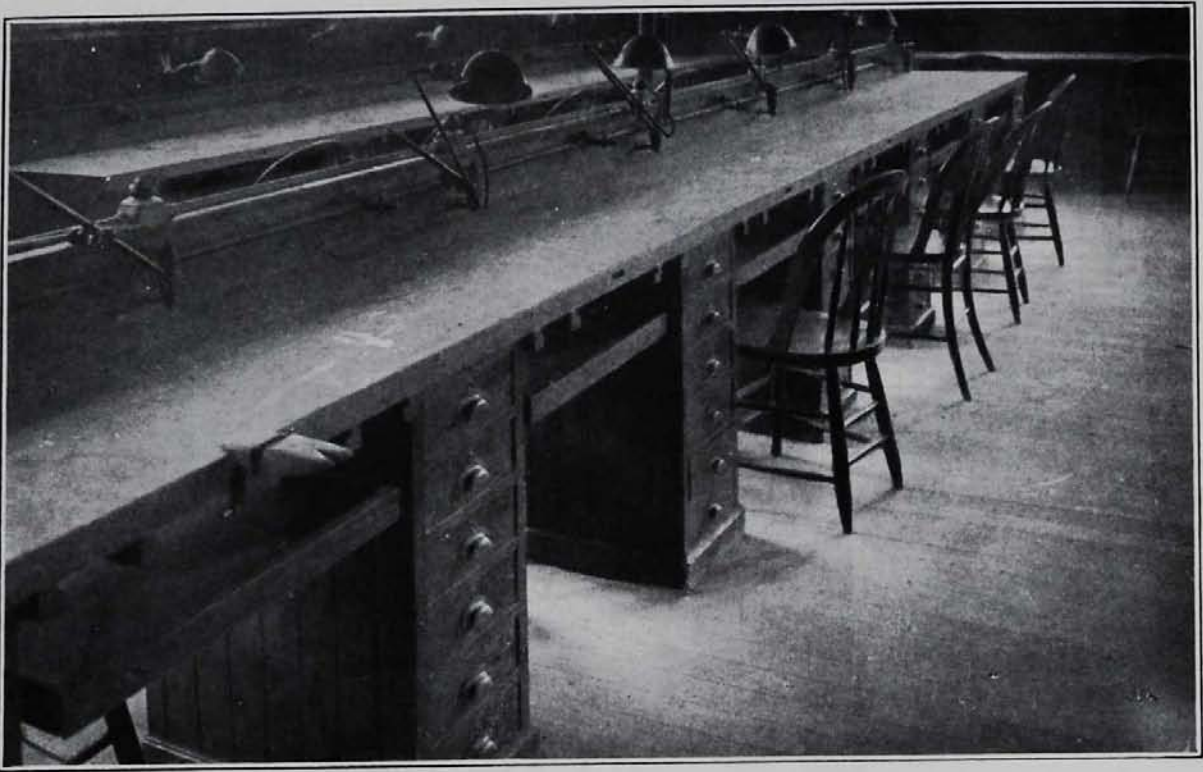


FIGURE 154

This unit bench and lockers in continuation is shown in plan, Figure 153DD, also in elevation, Plate LIII, and is a part of the equipment at the Technical High School, Providence, R. I. It has six individual lockers so that six different classes can use the room. Each locker is equipped with the outfit shown on Plate LI. Two pipes for gas and air run along the back of the bench. The method of lighting for work of this kind, where it is important to have the light directly on the work, is also shown.

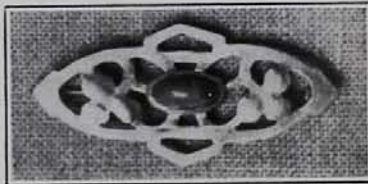
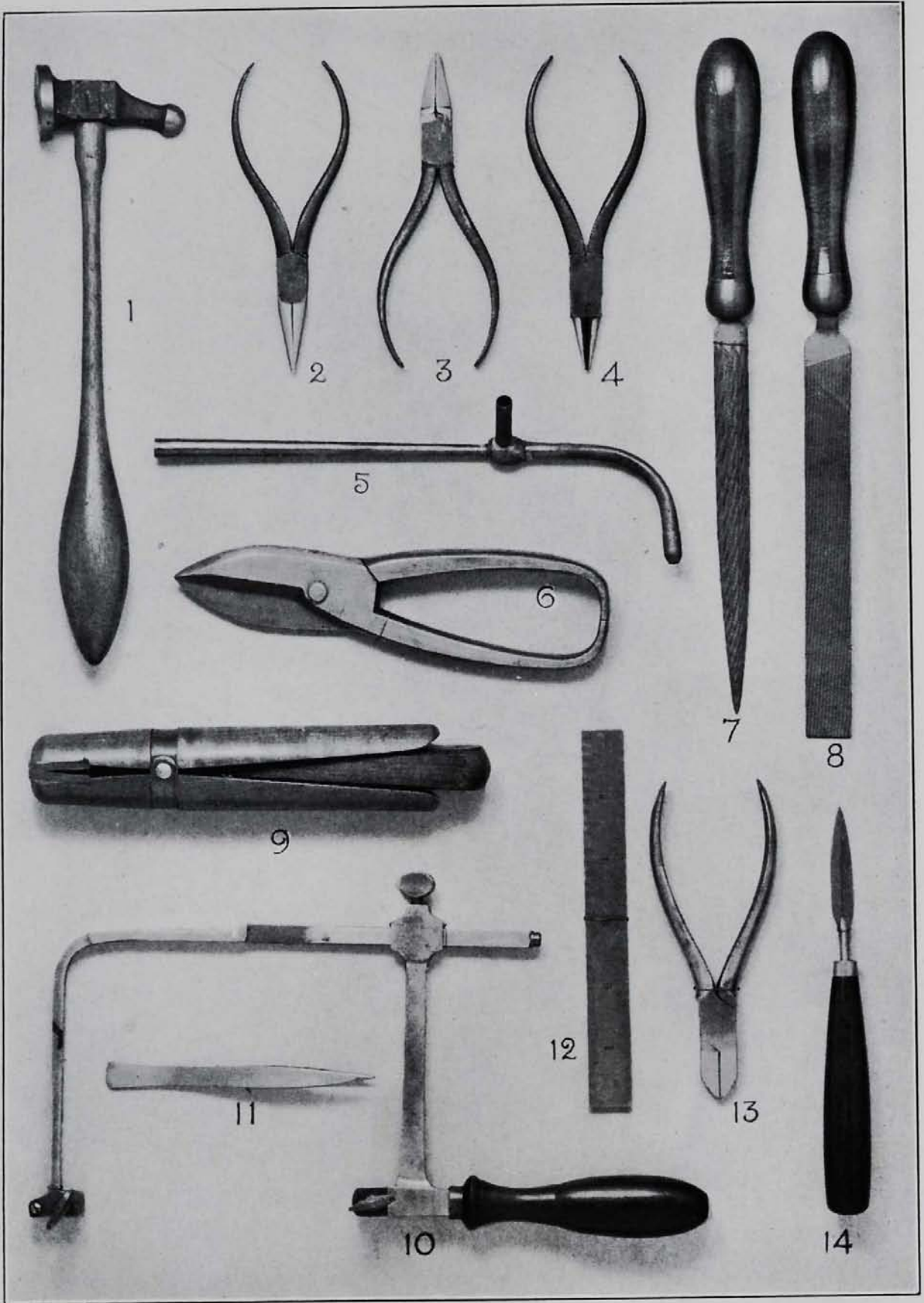




FIGURE 155

LOCKER CABINET

This cabinet contains 24 lockers, each locker is equipped with 24 pans and the tools shown on Plate LI. For work in jewelry requiring so many small tools it is impossible to keep the equipment together without individual lockers. This gives a locker large enough for work in jewelry but if the larger forms of metal work are carried on in connection with jewelry more space will be needed such as the locker shown on Plate LII.



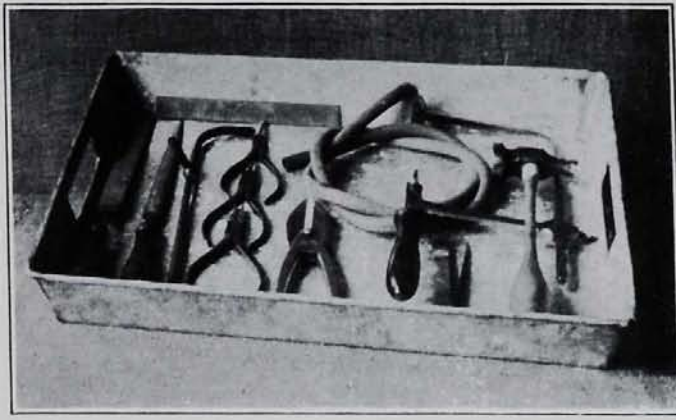


FIGURE 156

AN INDIVIDUAL EQUIPMENT

The pan of tools shown in Fig. 156 and on Plate LI is an individual equipment for school use. The pan is the most convenient way in which to keep tools together; when placed in the drawer under the bench it catches filings and scrap metal which is an important item when working in the precious metals.

The equipment consists of the following tools:—

- | | |
|----------------------|-------------------------|
| 1. Hammer | 8. Flat File |
| 2. Chain Pliers | 9. Ring Clamp |
| 3. Flat Nose Pliers | 10. Saw Frame |
| 4. Round Nose Pliers | 11. Tweezers |
| 5. Blow Pipe | 12. Steel Rule |
| 6. Shears | 13. Diagonal Cut Pliers |
| 7. Half Round File | 14. Scraper |





Locker Cabinet



FIGURE 157
Ring Sizes

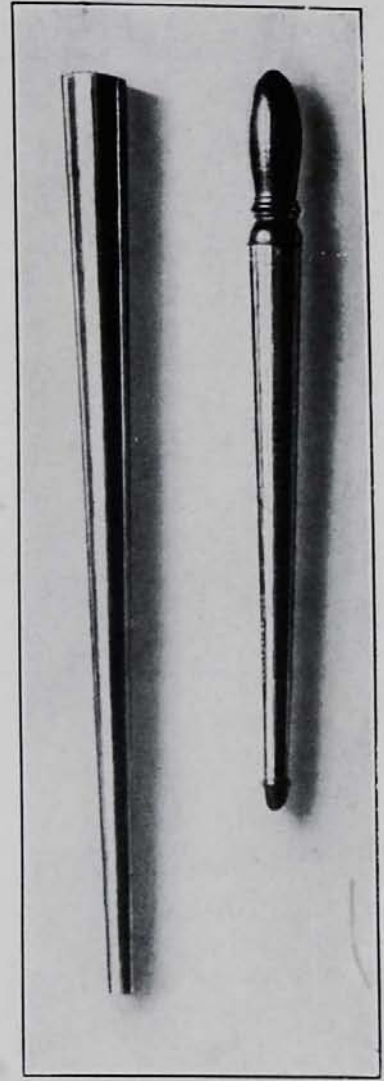


FIGURE 159
Ring Arbors

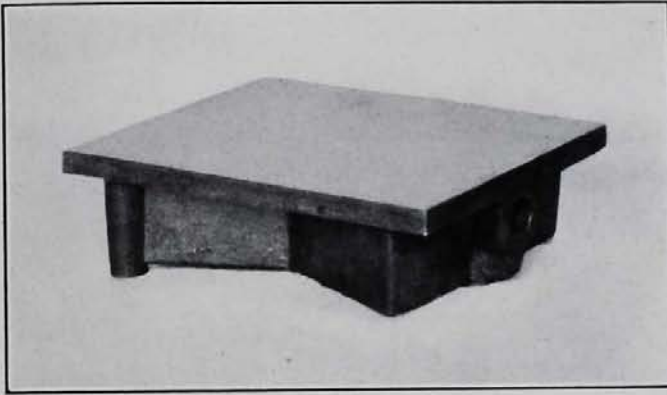


FIGURE 158
Surface Plate

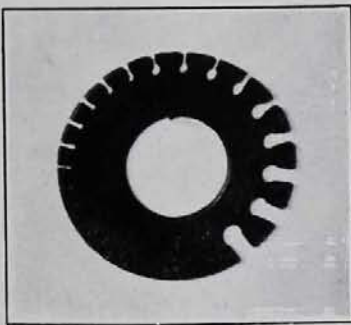


FIGURE 160
Gauge Plate

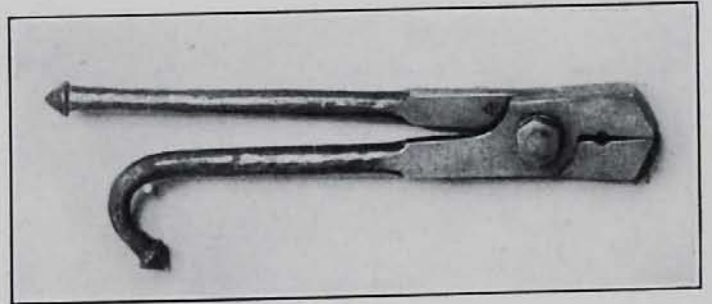


FIGURE 161
Draw Tongs

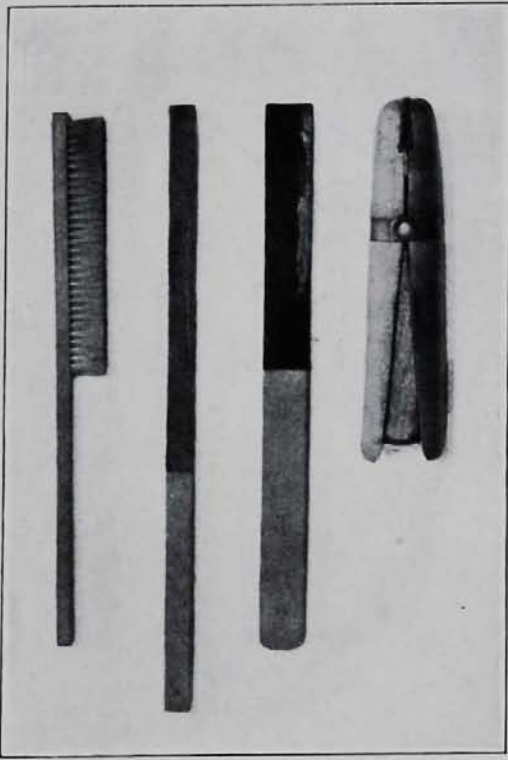


FIGURE 162
 Bench Brush
 Polishing Sticks
 Ring Clamp



FIGURE 163
 Burnisher
 Scraper
 Scratch Awl
 Center punch

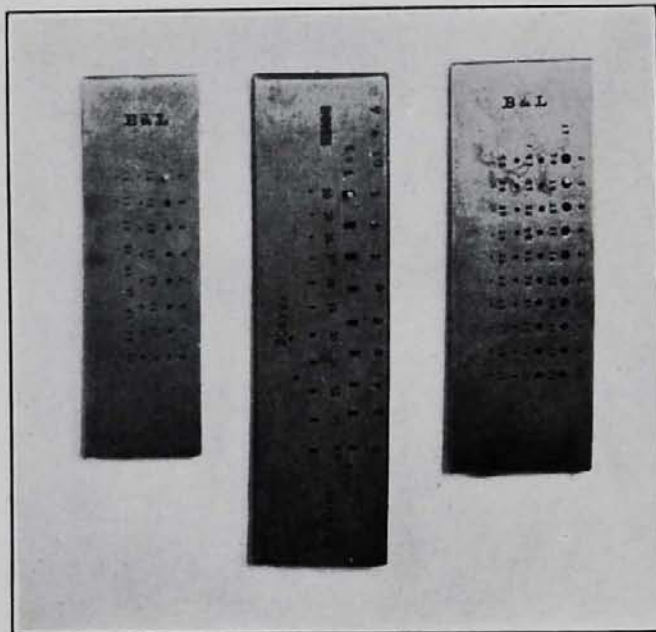


FIGURE 165
 Draw plates may be had in various
 shapes; the above are square, oblong,
 and round

LOCKER CABINET FOR JEWELRY WORK

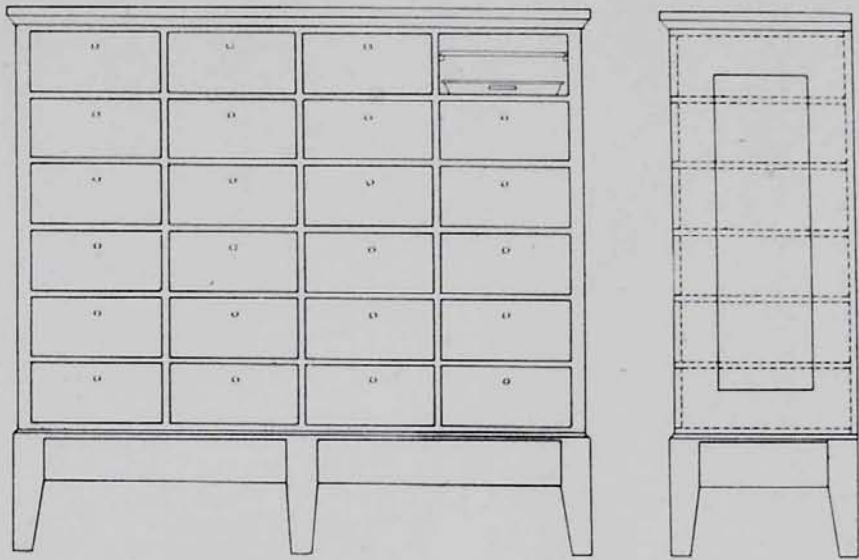
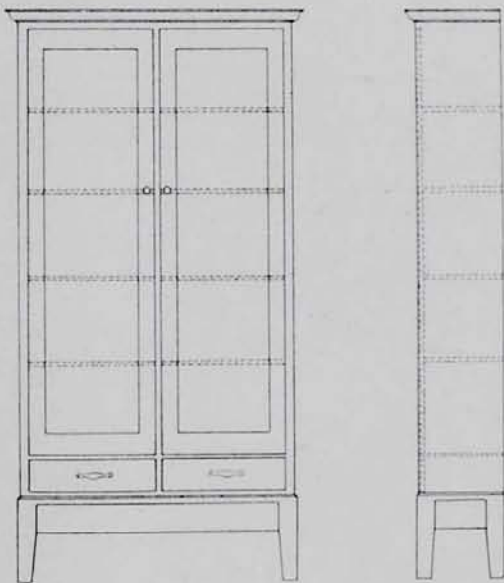


FIGURE 166 Elevation of Locker Cabinet as shown on Page 237

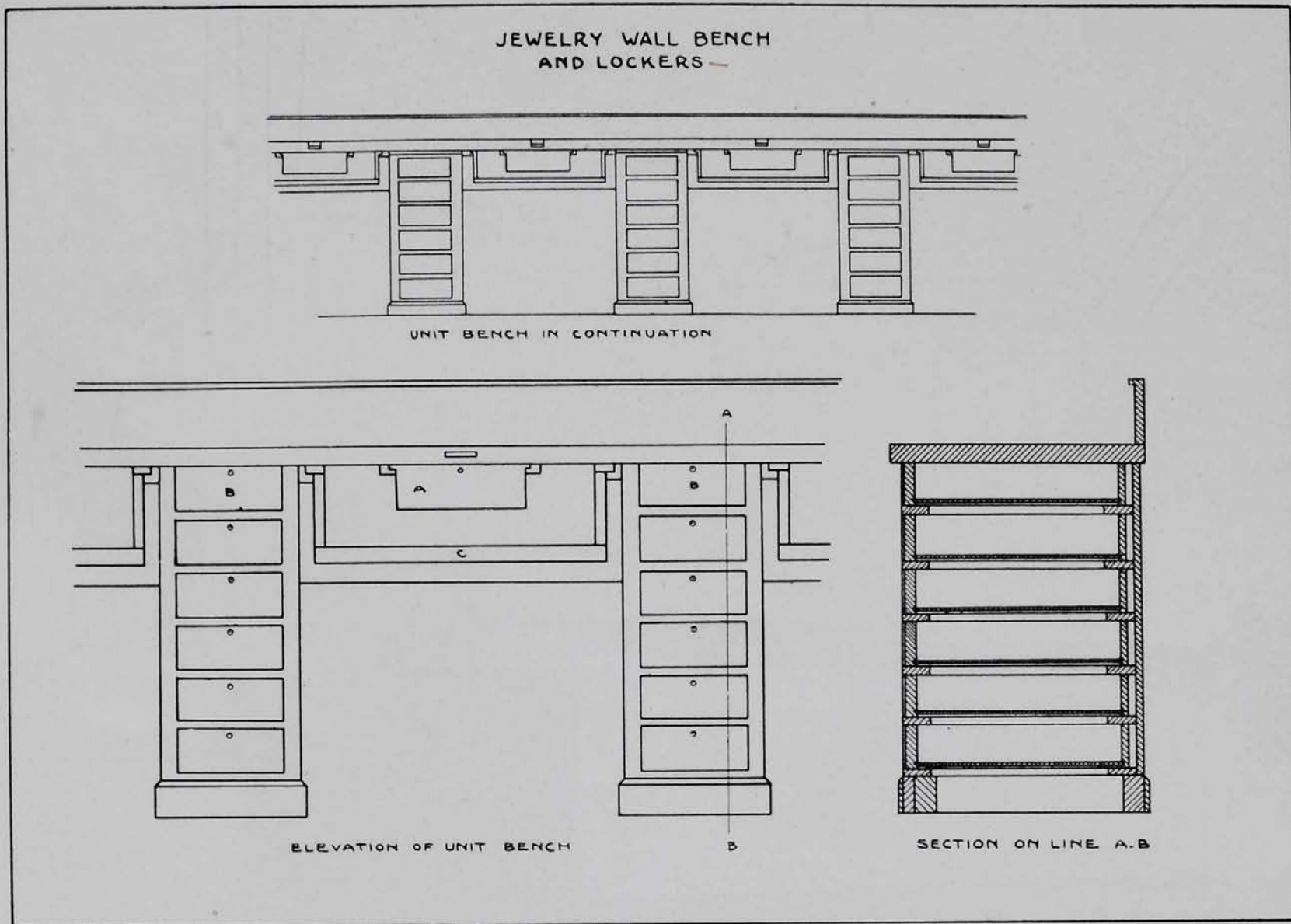
STORAGE CABINET
FOR
MATERIALS



STORAGE CABINET

The following materials for work in jewelry must be kept near at hand and may be stored in a cabinet of this kind. Sulphuric Acid, Nitric Acid, Turpentine, Alcohol, Shellac, Pumice, Ochre, Cement, Cut Quick, Rouge, Brushes, Metals, Stones, etc.

FIGURE 167

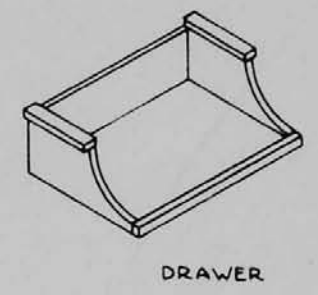
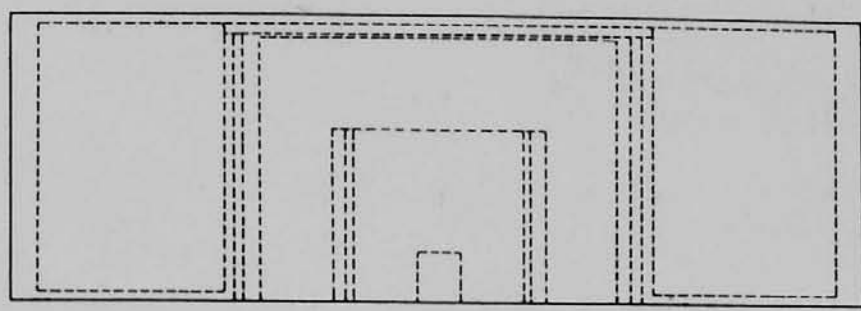
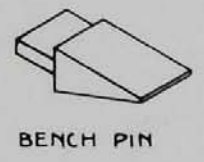


Elevation of Bench shown on Page 236, Figure 154

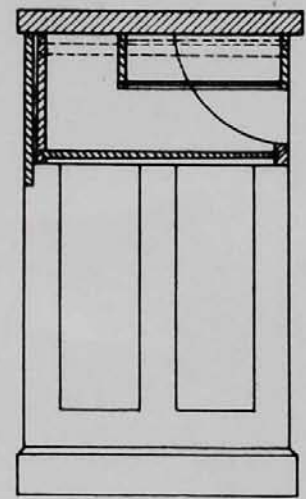


Jewelry Room, East Boston High School, Boston, Mass.

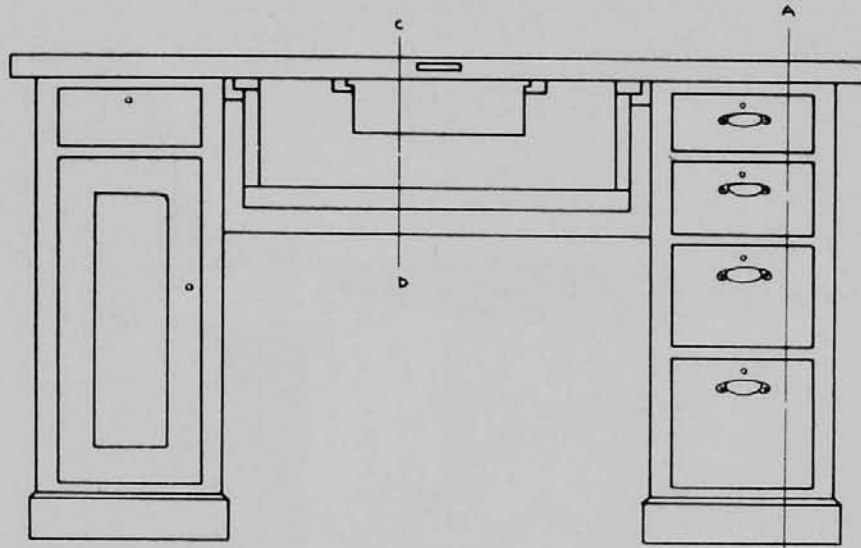
INDIVIDUAL BENCH



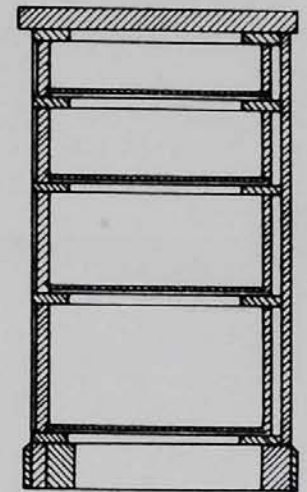
PLAN



SECTION ON LINE C-D



ELEVATION



SECTION ON LINE A-B

This bench is one that can be used for individual work or as a demonstration bench in the class room

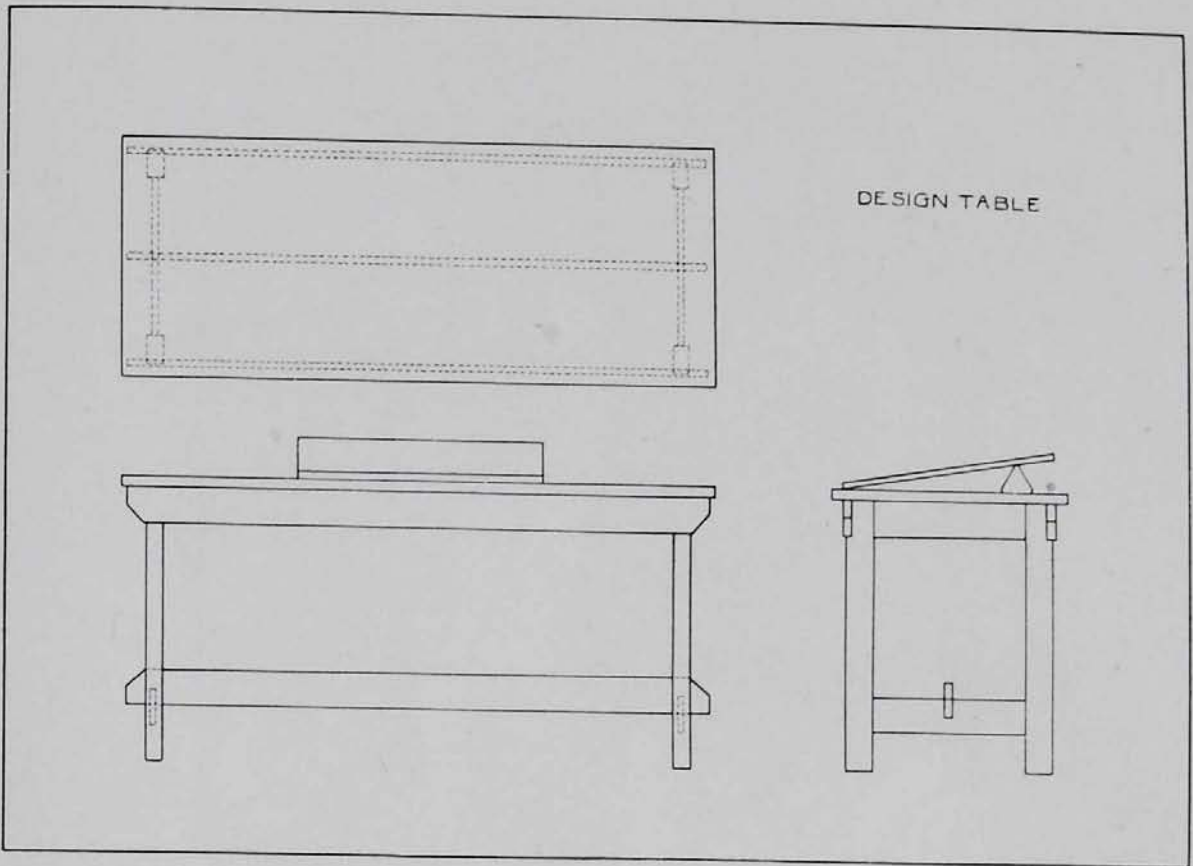


FIGURE 168
An inexpensive table for work in Design

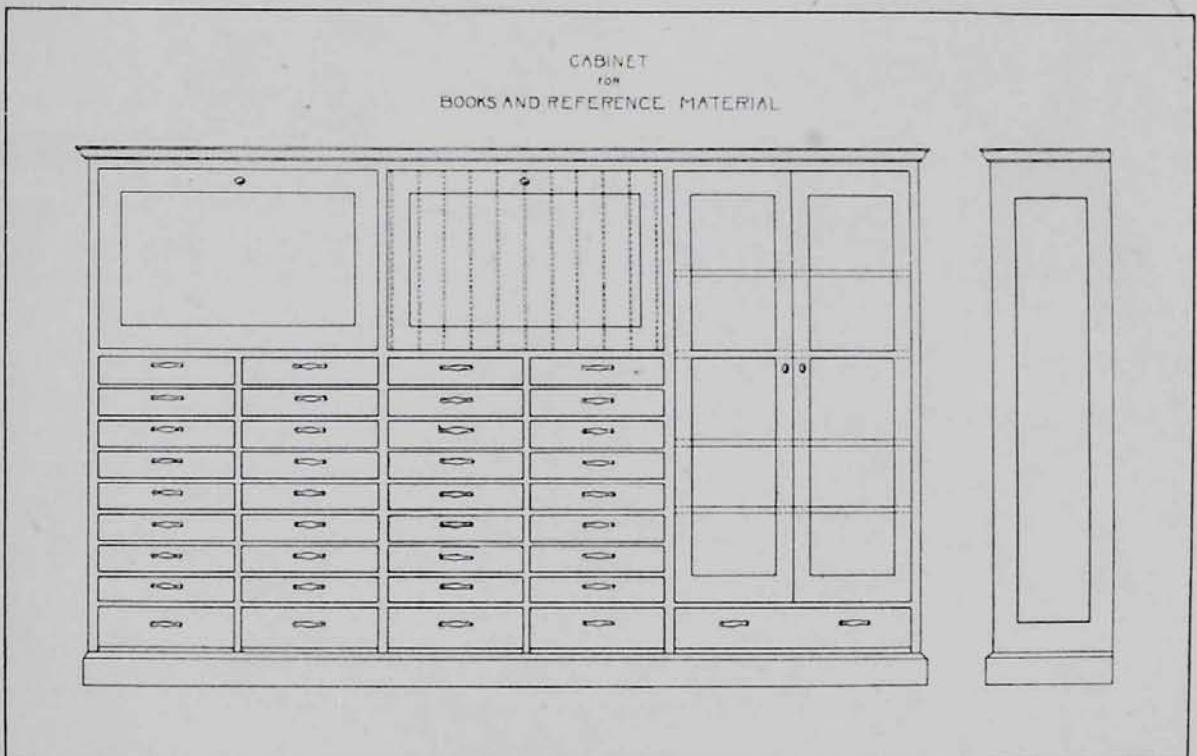


FIGURE 169
A cabinet like this is indispensable for the storage of books
and reference material

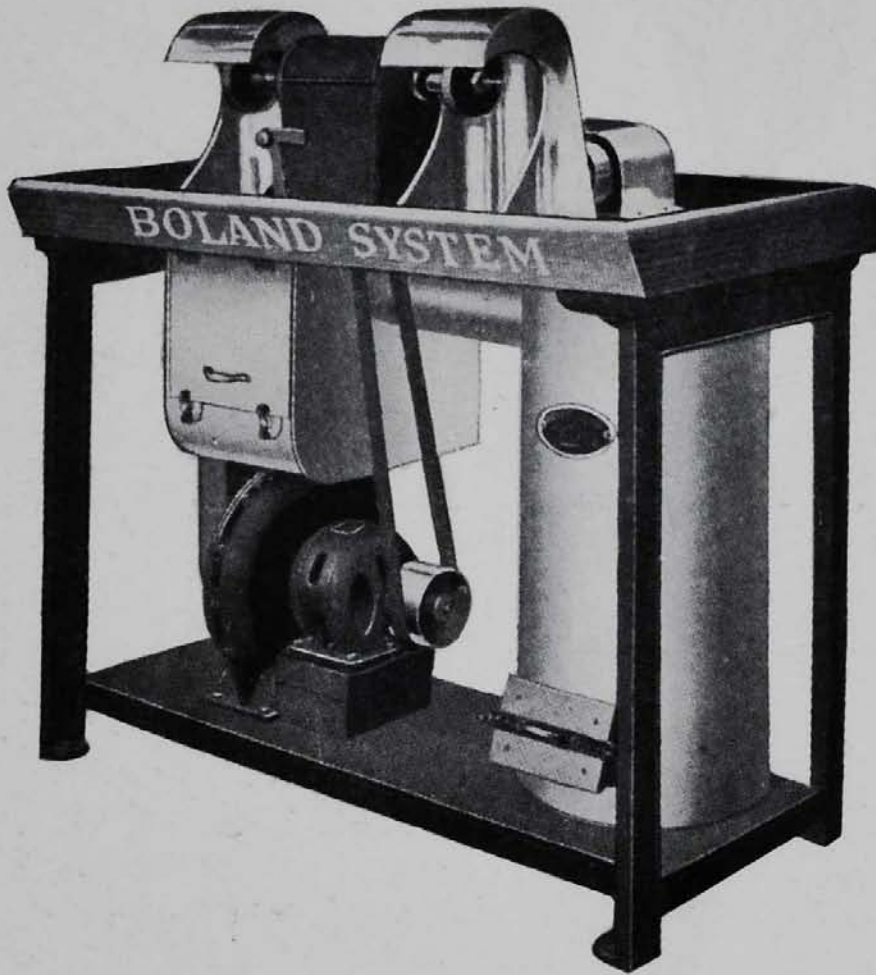


FIGURE 170
Polishing Bench

This Polishing Bench is indispensable to any school equipment. As it is portable it is possible to place it anywhere in the room. It is motor driven and has a dust collector and exhaust fan, an essential feature as dust and dirt are unavoidable in polishing.

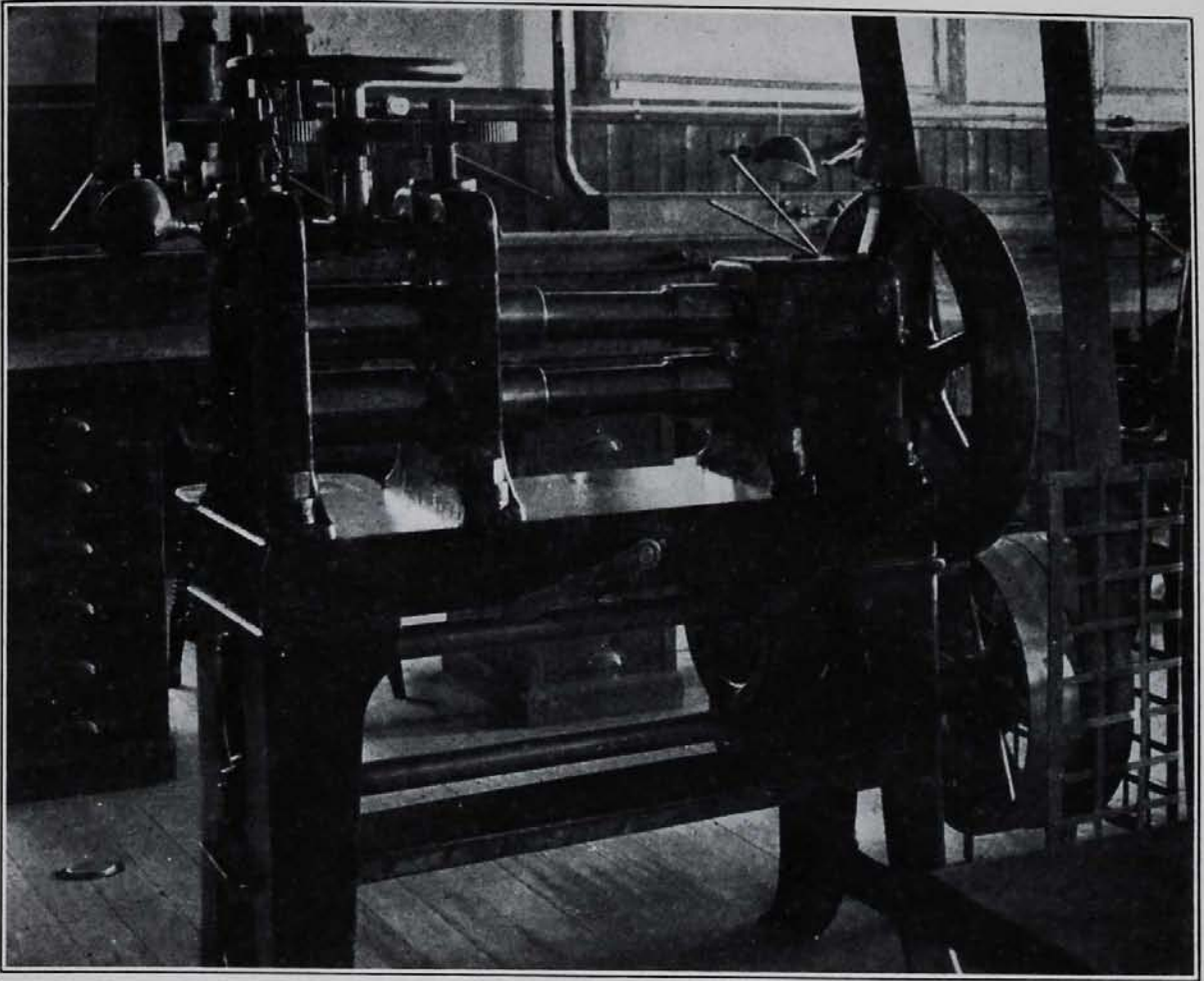
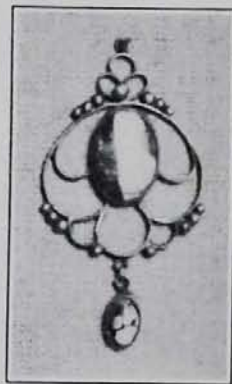


FIGURE 171

Flat Roll

No equipment is complete without a flat roll for reducing the thickness of flat stock. With a roll like this one above, and a melting furnace it is possible to melt and pour the metal into ingots and roll it to the required thickness.



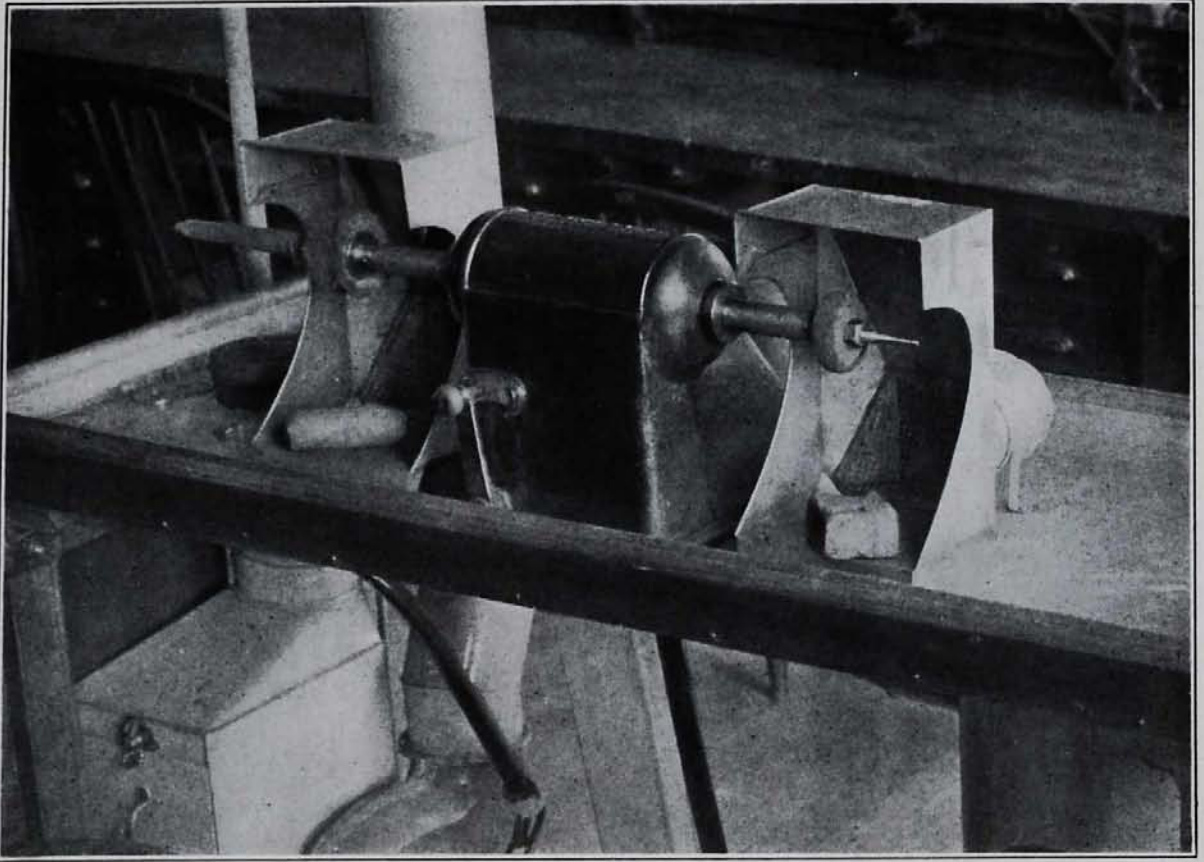
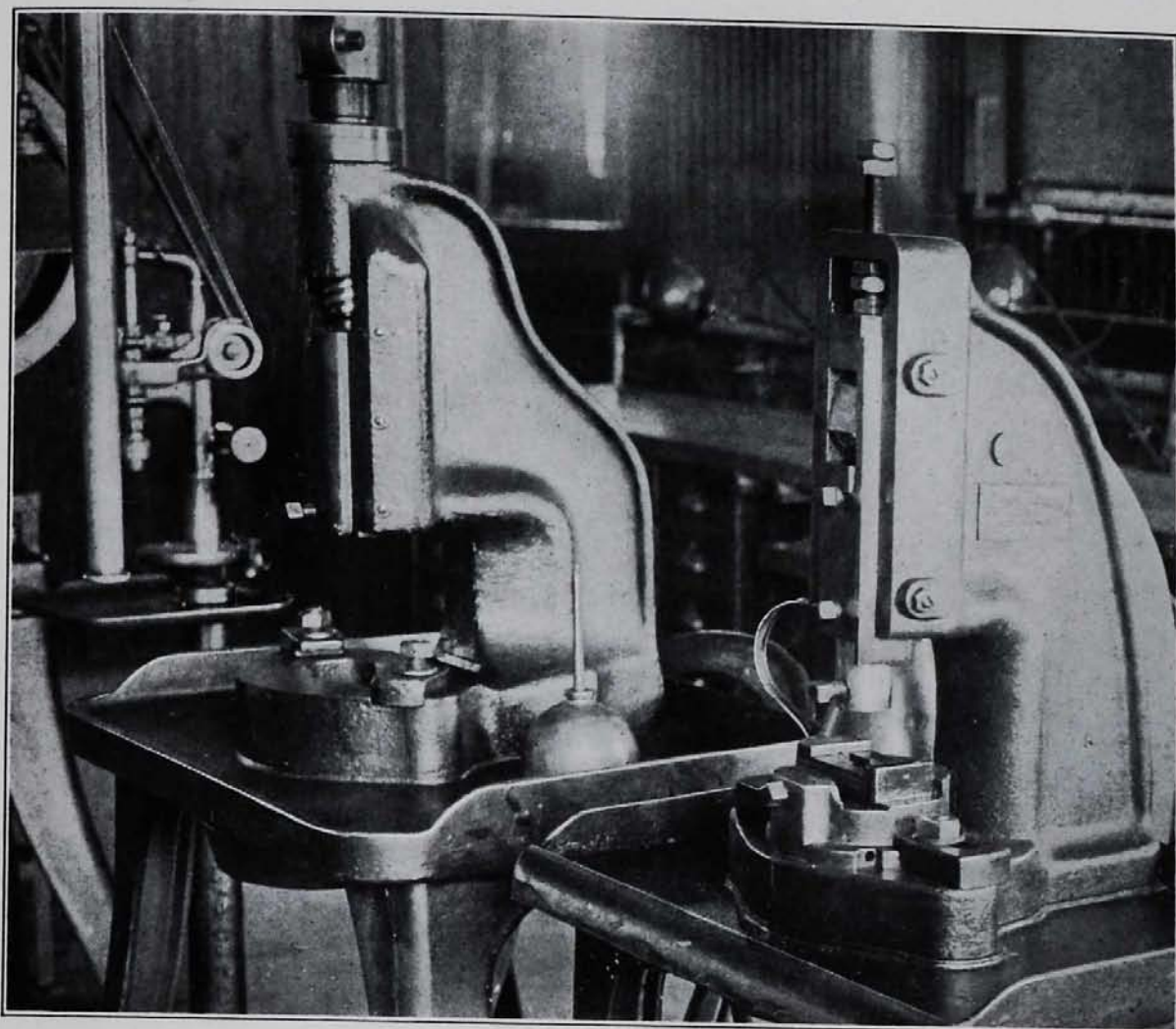


FIGURE 172
Polishing Head showing
dust collector



FIGURE 173
Roll Top Sawdust Box for
drying work after
pickling

FIGURE 173



Screw Press

FIGURE 174

Kick Press

These presses are used when work is produced with the die

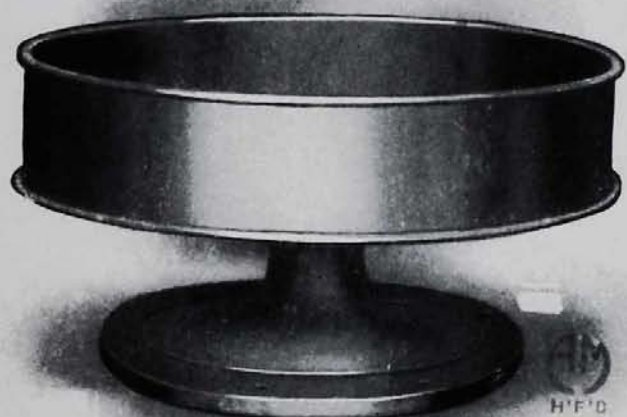


FIGURE 175

Annealing or Soldering pan
used for large work

FIGURE 175

FIGURE 176

Pickle tank and automatic Furnace. This tank is lead lined with a coil of pipe at the bottom so that the pickle may be kept hot

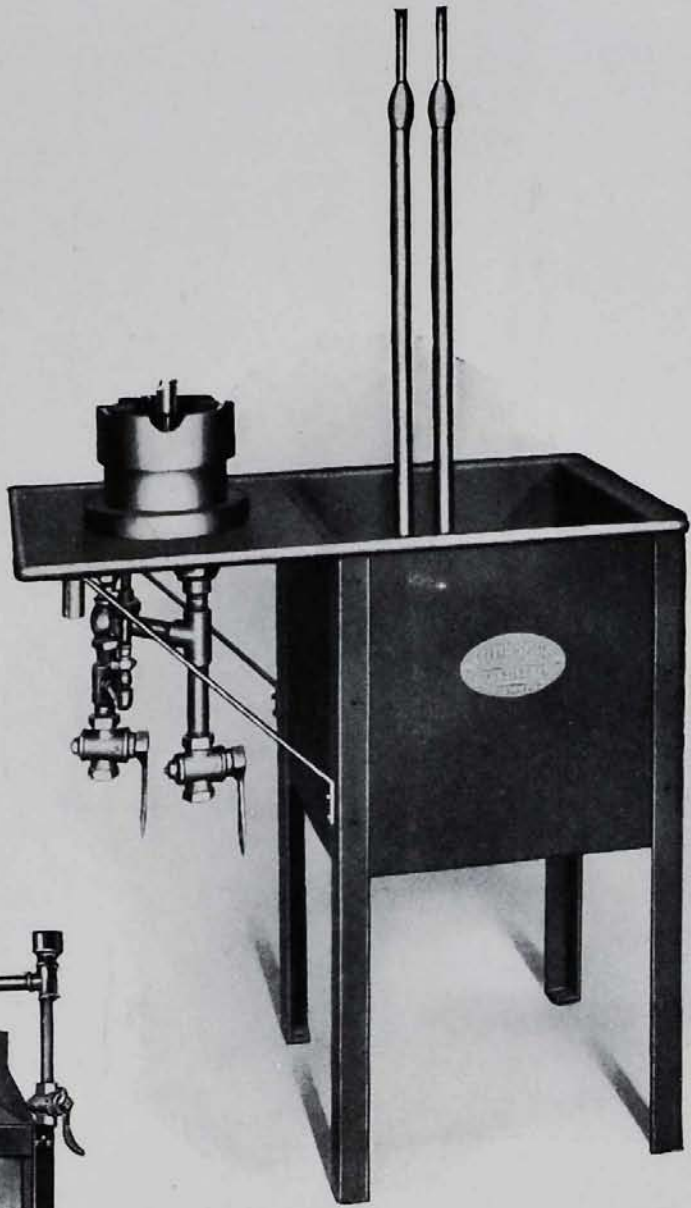


FIGURE 176



FIGURE 177

FIGURE 177

Sand Blast. This is used to give jewelry a finish obtained in no other way. Air pressure is necessary in using this blast



FIGURE 178

Most jewelry is finally finished by coloring or Electro-plating. The above equipment is most complete and serves every purpose for school use



FIGURE 179

In jewelry work air pressure is an essential feature. A Blower like the one here illustrated is indispensable



FIGURE 180

This motor driven Bench Drill is a very satisfactory one for use in jewelry making. It will take a drill of any size up to $\frac{7}{32}$ of an inch and has an adjustable table. It has three speeds of 3500, 2260, 1255 revolutions per minute. It takes up but a small space on the table and requires no special wiring as it can be connected by a plug with any ordinary lighting circuit and is controlled by a snap switch.

BOOK II
JEWELRY DESIGN

•••

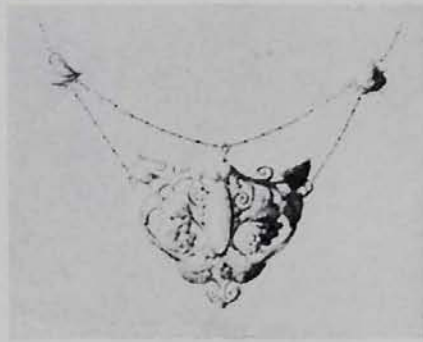
Introduction to Jewelry Design

IN jewelry design, as in other forms of design, the problem always begins with certain given conditions or requirements which must be kept in mind throughout the designing process. We must first consider its use, and ask the question, Is it to be a brooch, pendant or ring? Then, as most pieces of jewelry are nothing more than the setting of some precious or semi-precious stone, it is necessary to know not only the kind of stone to be used but its size and shape before anything can be done, and it would be better if it were designed expressly for the person who is to wear it. The purpose in jewelry design is to add interest to construction, but in doing this the designer must continually keep in mind the purpose and material. In designing a finger ring, for example, the object is to secure or set a stone in a band of metal which is to encircle the finger. The problem is a ring. The materials are a stone and the metal, which may be either silver, gold, or platinum. It is possible to carry out such a problem in a very simple manner, having no ornamentation whatever, only a proper relation between stone and metal; that is, having the right amount of metal visible in relation to the stone used. There must be, however, refinement of line in the modeling of the metal to have it in keeping with the stone. A precious stone with delicate, transparent coloring should be treated quite differently from a semi-precious stone of opaque coloring.

If ornamentation is desired it is still necessary to keep in mind its purpose and the material used.

Interest may be added to the construction in various ways. The surface of the metal may be broken up by modeling or carving some intricate pattern, giving an interesting play of dark and light, or the metal may be treated in a lighter or more open work manner by piercing or removing as much of the metal as is possible without affecting the strength of the setting, the decoration resulting in beauty of line and silhouette. In this method there are splendid opportunities for design.

The ring is simply used as an illustration; all other forms of jewelry may be treated in the same manner. Before the student of jewelry design can work out any of the problems he may be called upon to execute, he must be led to design intelligently for himself so that he will not be dependent on others for ideas. He must be led along various lines which will give him the necessary equipment. First of all he must study nature, but before he can appreciate her exquisite detail, a knowledge of drawing must be acquired.



Chapter XXII
Jewelry Drawing

A THOUGHT graphically expressed often makes clear the obscure meaning of words. If the student hopes to demonstrate his ability in creating ideas, it is essential that he develop facility in the use of the lead pencil. This may be acquired by a

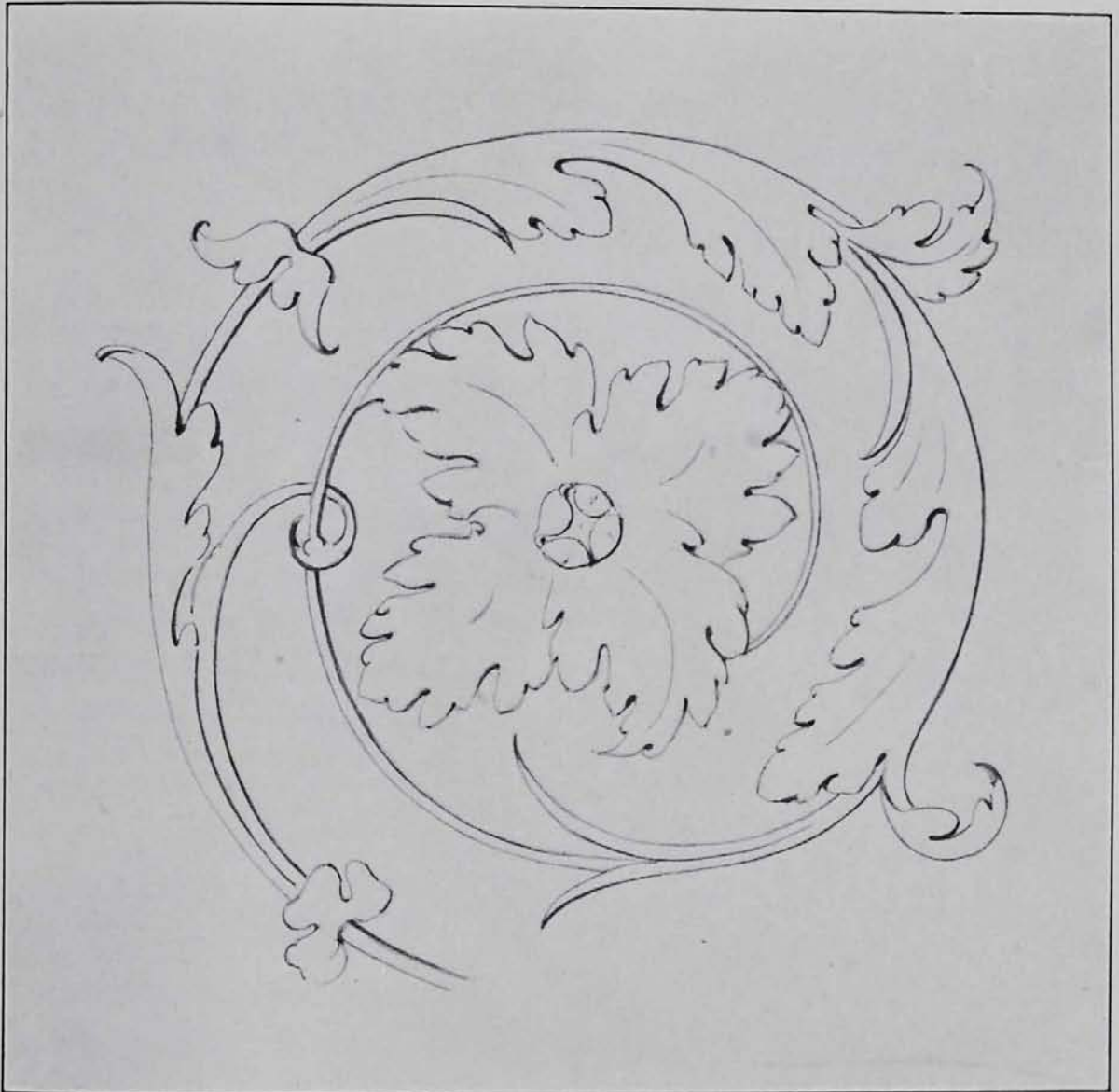
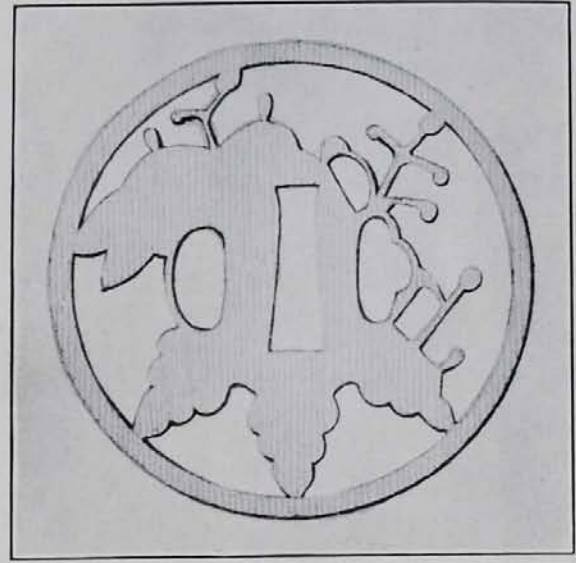


FIGURE 186



A

FIGURE 187



B

systematic course of exercises at the end of which the student will have gained ability enough to enable him to present ideas with clearness and precision.

The plates here represented show sequence only, while the amount of repetition required to pass from one subject to another is not indicated. Previous training in charcoal drawing from still life or cast furnishes an excellent basis for jewelry drawing, as the aim of this work is to gain a wide appreciation of line and form, with ability to record them. The subject matter used for the work in drawing such as casts, shells, sword-guards, flowers, historic ornament, metal work, etc., has three distinct values: first, the student is trained to draw accurately; secondly, he becomes acquainted with the orderly way in which nature occurs; and thirdly, he acquires a knowledge of forms and shapes which he makes use of in design later in the course.

The first exercise is to make some large drawings of casts on a 10" x 14" pencil paper pad using a medium grade pencil. If the cast is symmetrical on either a vertical or horizontal axis, it will facilitate matters to sketch the axis or axes free hand. Block out the general contour with straight lines. When doing this

do not make one half of the drawing on one side of the center line and then proceed to make its corresponding half. It is more in accordance with the art of drawing to carry the two sides together. Whatever is done on one side of the center line should be done on the other side almost simultaneously. Points on one side of the drawing are carried across to the opposite side by light lines. When the drawing has been roughly sketched in straight lines, securing the large masses, rub it lightly with a piece of art gum in one direction only. Rubbing the drawing in one direction while erasing should be practised till it becomes a habit. As amateurs are prone to rub in a back and forward motion they assume the risk of creasing the paper. Now that the paper is clean and contains a faint impression of the drawing, proceed to make the sketch more accurate in detail and at the same time obtain a more finished line. It is sometimes necessary to go over the drawing three or four times before the final line is drawn, the idea being that after the drawing has been roughly blocked out in straight lines the largest curves are laid in, then the smaller curves, and so on down to the smallest detail. In other words it is proceeding from the whole to the parts. When the drawing is clean and free from ragged edges, assume the light falling from the upper left hand side and accent the shadow side as represented by the drawing, Fig. 186.

After several of these large drawings have been made it will be well to reduce the size. Instead of making one drawing on a sheet 10" x 14" make two by dividing the paper into two rectangles 5" x 8" with a half-inch margin around the outside of each, and making one drawing in each rectangle.

METAL

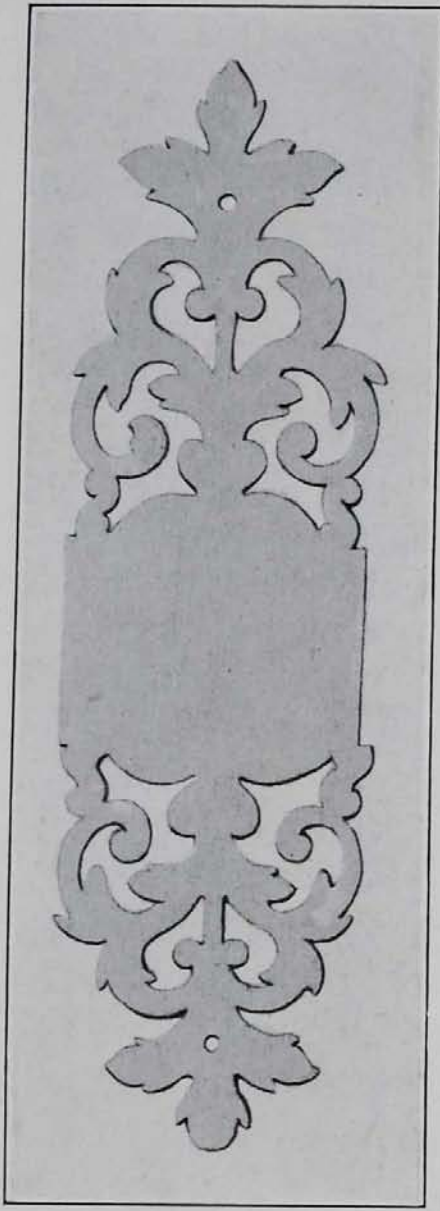
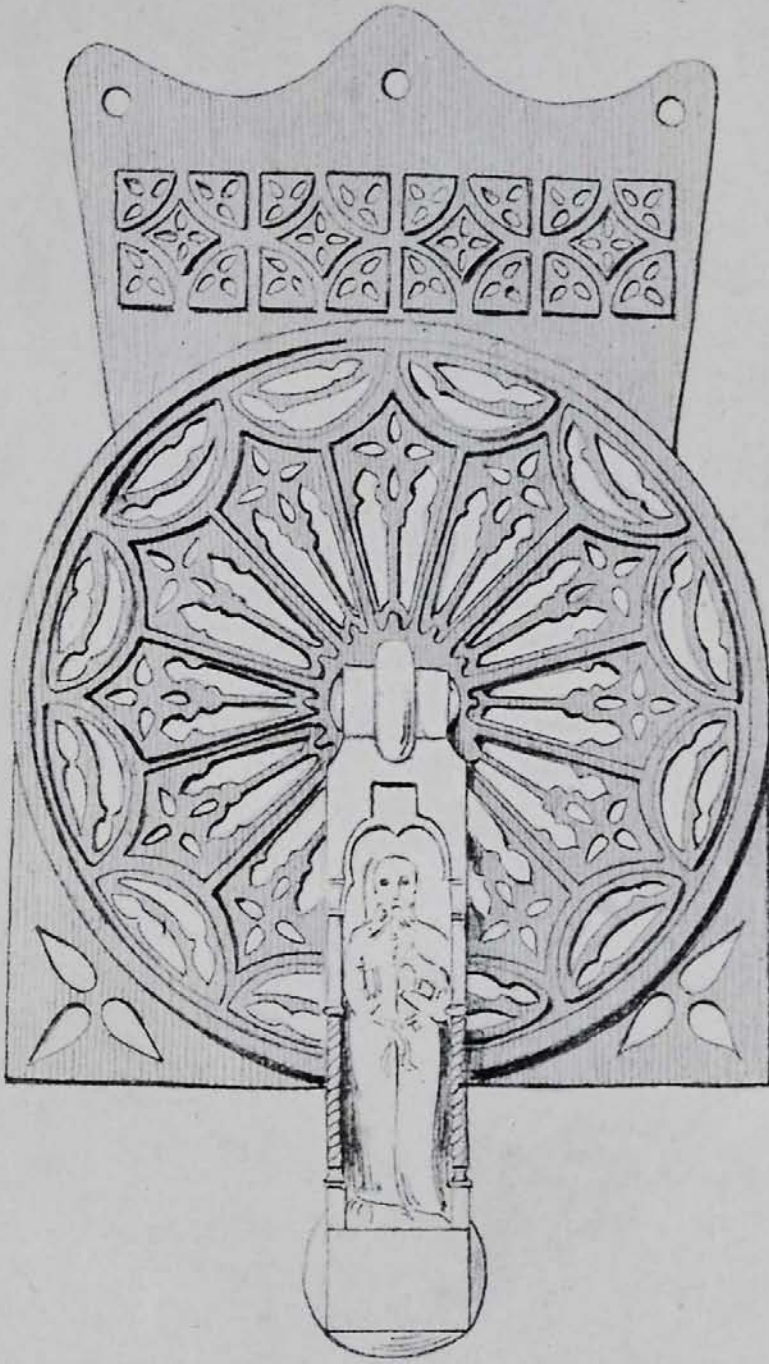


FIGURE 188

Working from the cast thus far has acquainted the student with different natural forms in their application as leaves, buds, scrolls or flowers, etc.; with an idea of growth, structure and natural order, besides a feeling of line, proportion and pencil technique. While the work is yet fairly large in scale it may be changed in character to inculcate the way these natural forms as motifs are used in metal. For this work fine examples of Japanese sword-guards or metal plates, escutcheons, or door pulls, etc., furnish excellent subjects. Figure 187 represents the sword-guards carefully drawn to impart that fineness of proportion and delicacy of curve so characteristic of Japanese work. These may be made full size on a 5" x 8" sheet. Figure A on this plate is merely the accented outline drawing and

should be repeated till a clean firm line that is full of surety and expression is attained. Figure B is more interesting perhaps than the previous exercise on account of its dark and light effect. The part representing the metal surface is cross-hatched freehand with vertical lines about $\frac{1}{32}$ of an inch apart and about 1 inch long. These lines must be uniform in darkness as well as in width. Cross-hatching should be practised on another piece of paper before proceeding on the final drawing. A little practice will show that the pencil must be turned with every few strokes in order to produce uniformity of width. Wherever it is necessary to



continue the length, the continued lines should not join the former but start directly below. If the lines are joined, a dark streak across the drawing will be the result. When the metal part is covered, the vertical lines should apparently blend thus producing a fine even tone of gray. The dark shadow lines that represent the thickness may be done before or after the cross-hatching. The sword-guard exercises, or whatever is used as a substitute, should range from large simple perforations to more complex ones till it is possible to execute intricate patterns.

This takes us to such examples as represented by Plate LVI. This design shows an abstract motif in perforation. The copying of such a design ought to reveal the way dark and light masses are arranged for decoration. The technique in this figure and in the succeeding ones on page 278, Figure 191, is identical in method. These perforated designs should be selected with the keenest sense of discrimination for good line and fine proportion. While the size of the drawings here may vary, their relative proportions should be identical with the example chosen. The copy should conform line for line and should record even what may appear to be accidents.



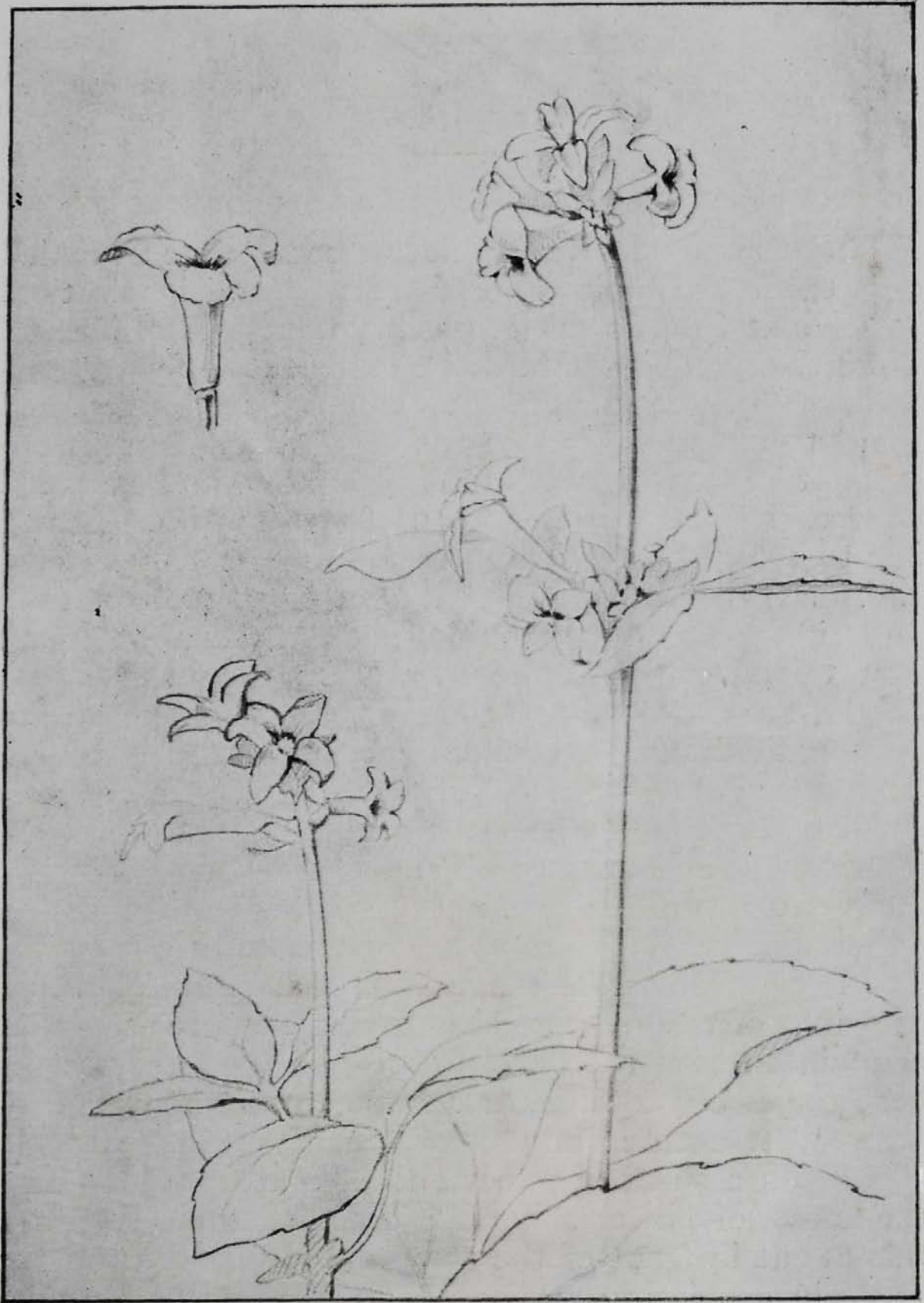
Chapter XXIII
Nature Drawing

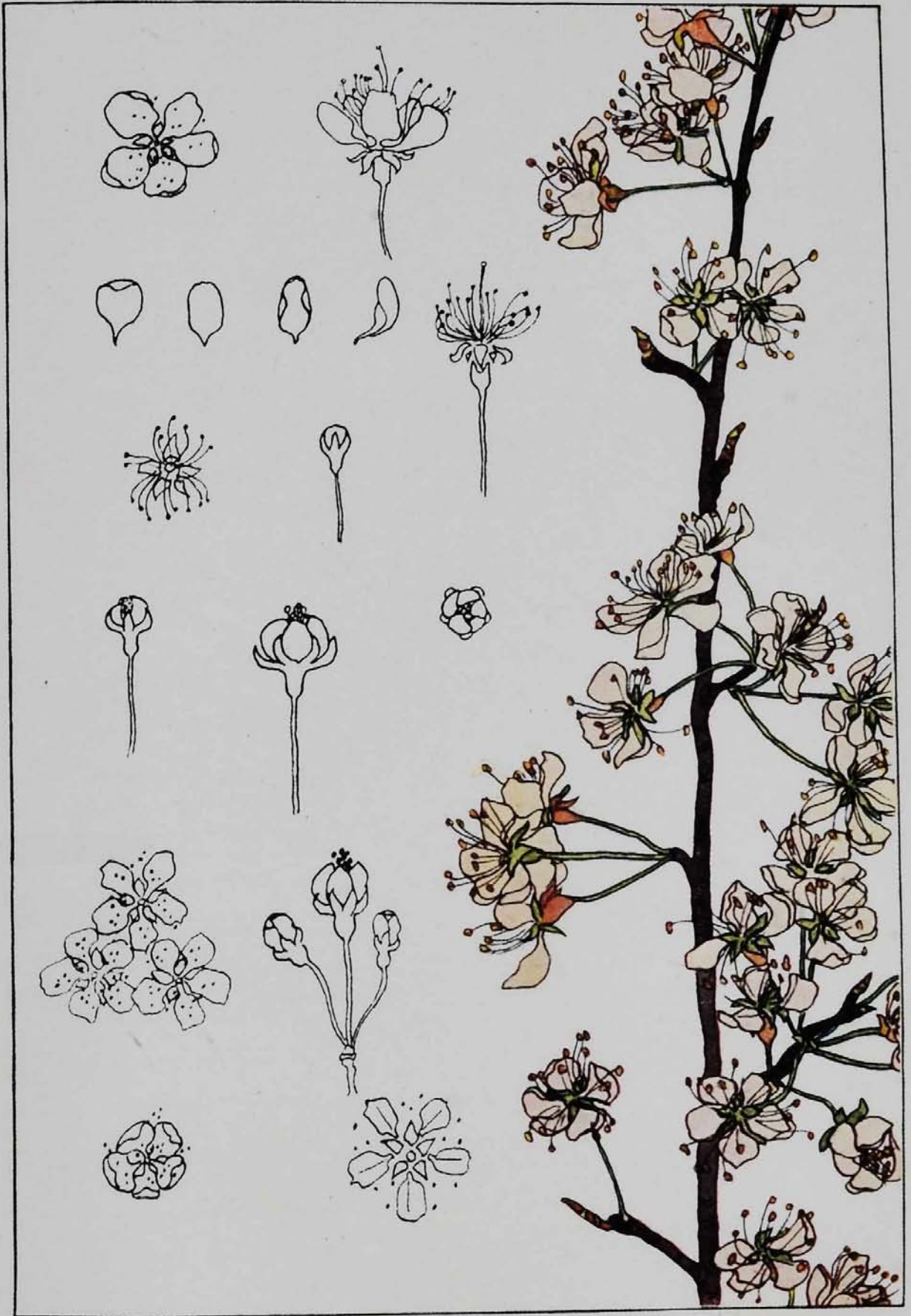
DRAWING FROM PLANTS AND FLOWERS

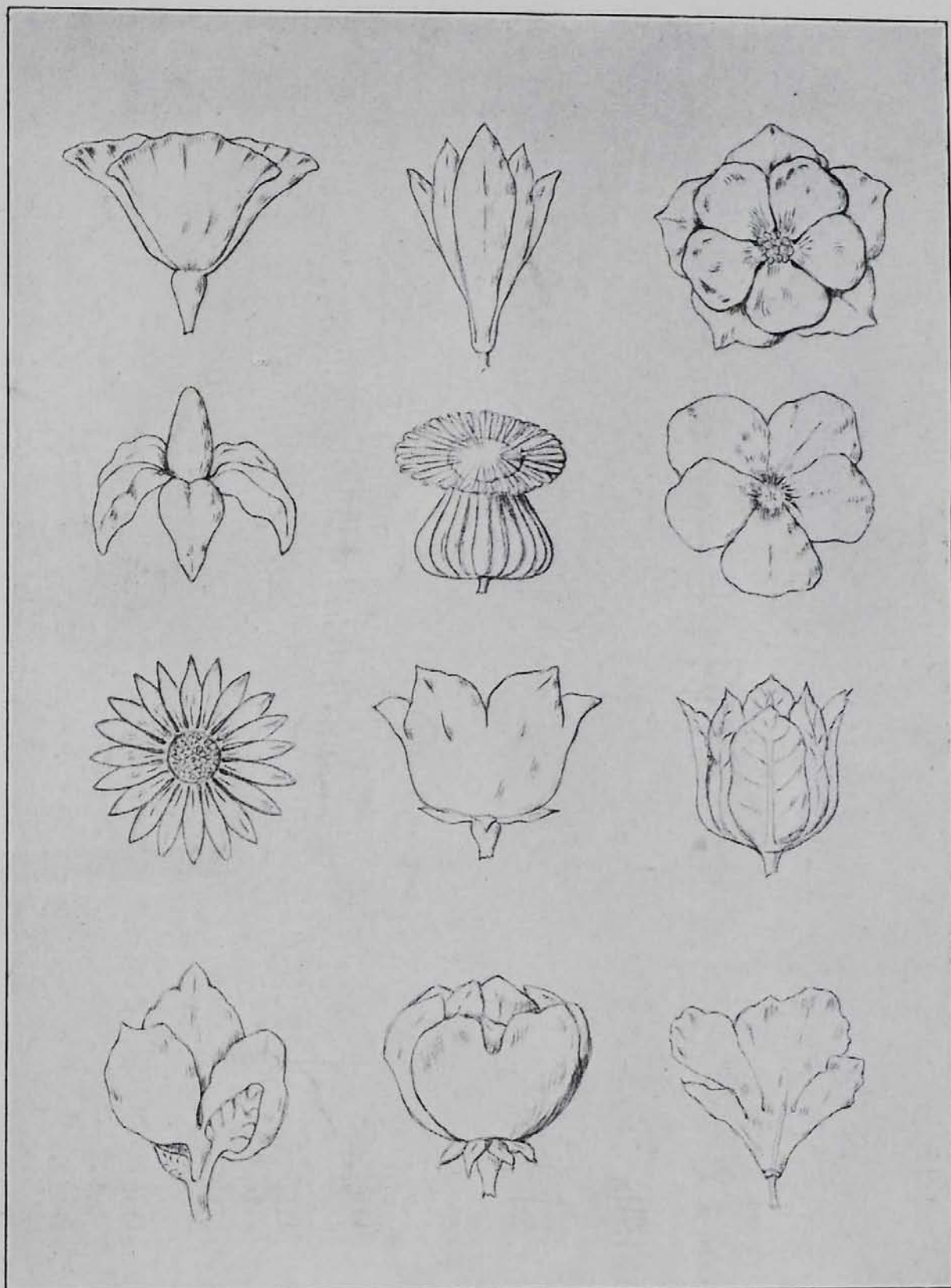
THE boundless field of nature sets before us multitudes of simple forms for study and inspiration. Plant form in all its phases, the world of insects, marine, animal, and bird life, are but a few of the sources for the student to draw from. To the untrained mind they are limited or entirely hidden, but to the student of design with a gift for keen and accurate observation, they offer no end of possibilities. Learning to see and understand nature comes only after a careful and enthusiastic search for her more minute and insignificant productions. The student must first take the flower, leaf, or fruit; the butterfly or beetle; the fish, shell, or the crystal, and make careful systematic drawings, beginning with the whole, studied from all points of view, then passing to the detail.

Studies thus made when translated into terms of jewelry will be found to possess endless suggestions of ideas and an unfolding of nature's laws, which must be adhered to by all designers, will be the student's reward.

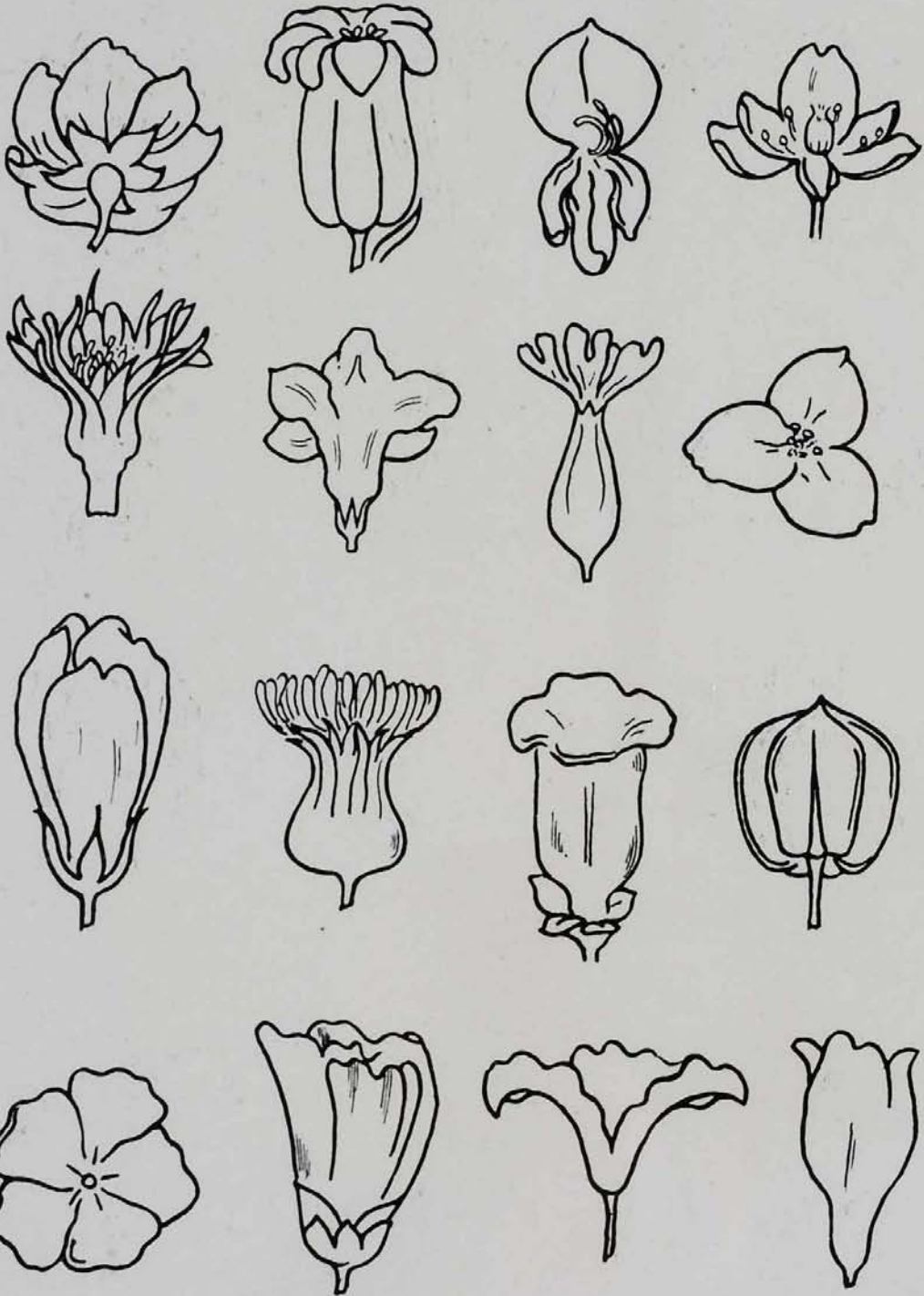
If fresh flowers are available make careful pencil drawings of them. The aim of this exercise is to get acquainted with the floral forms that lend themselves best to jewelry designs, also to gain a knowledge of growth, structure, and color. Cut out a rectangle 5" x 8" on a sheet of paper and hold it upright before the spray of flowers. This is called a finder. Move this about in front of the spray till it seems to fill the space in a pleasing manner, avoiding similar or equal distribution of masses. The spray should apparently fill the area without necessarily covering the space.



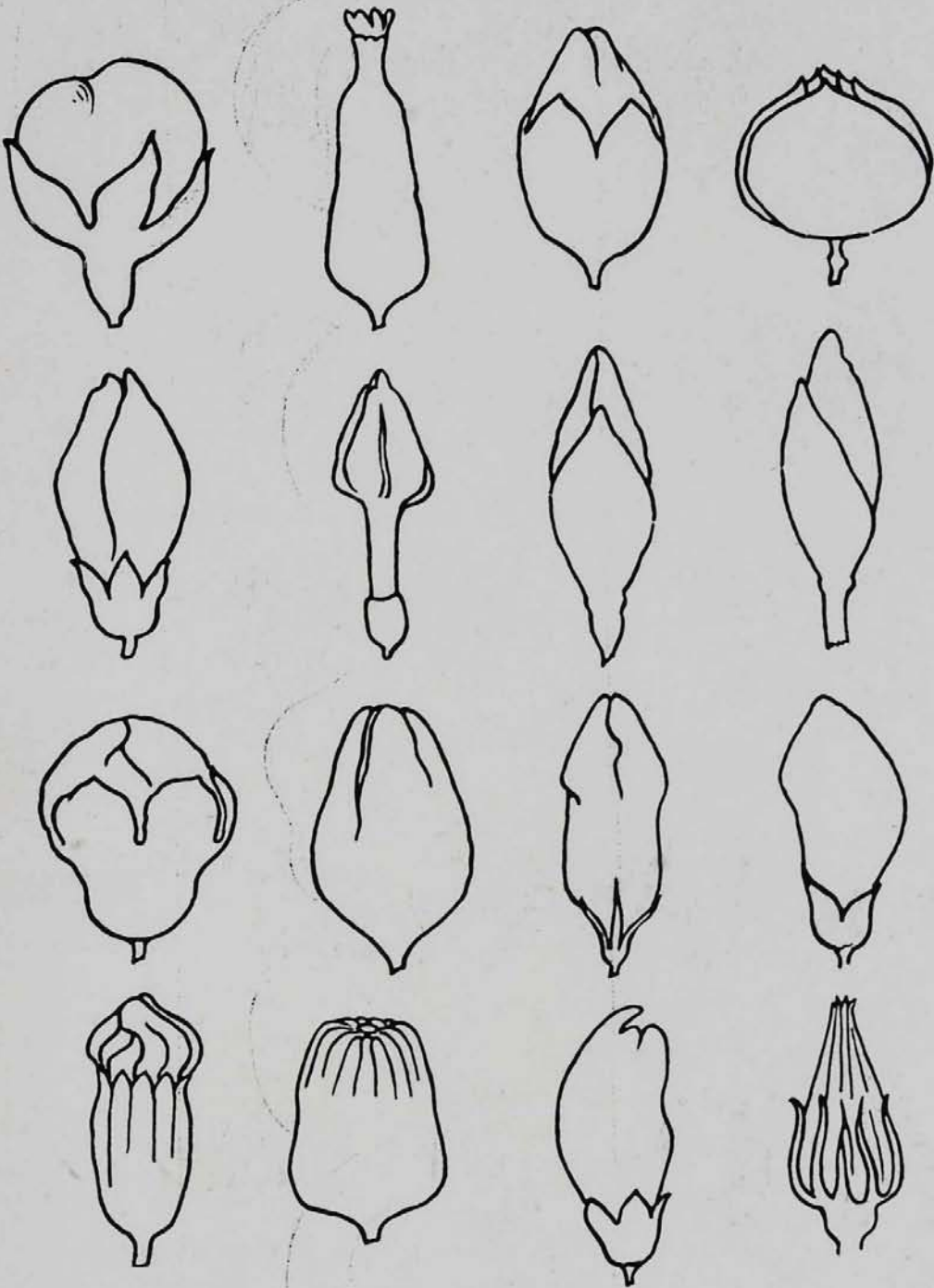




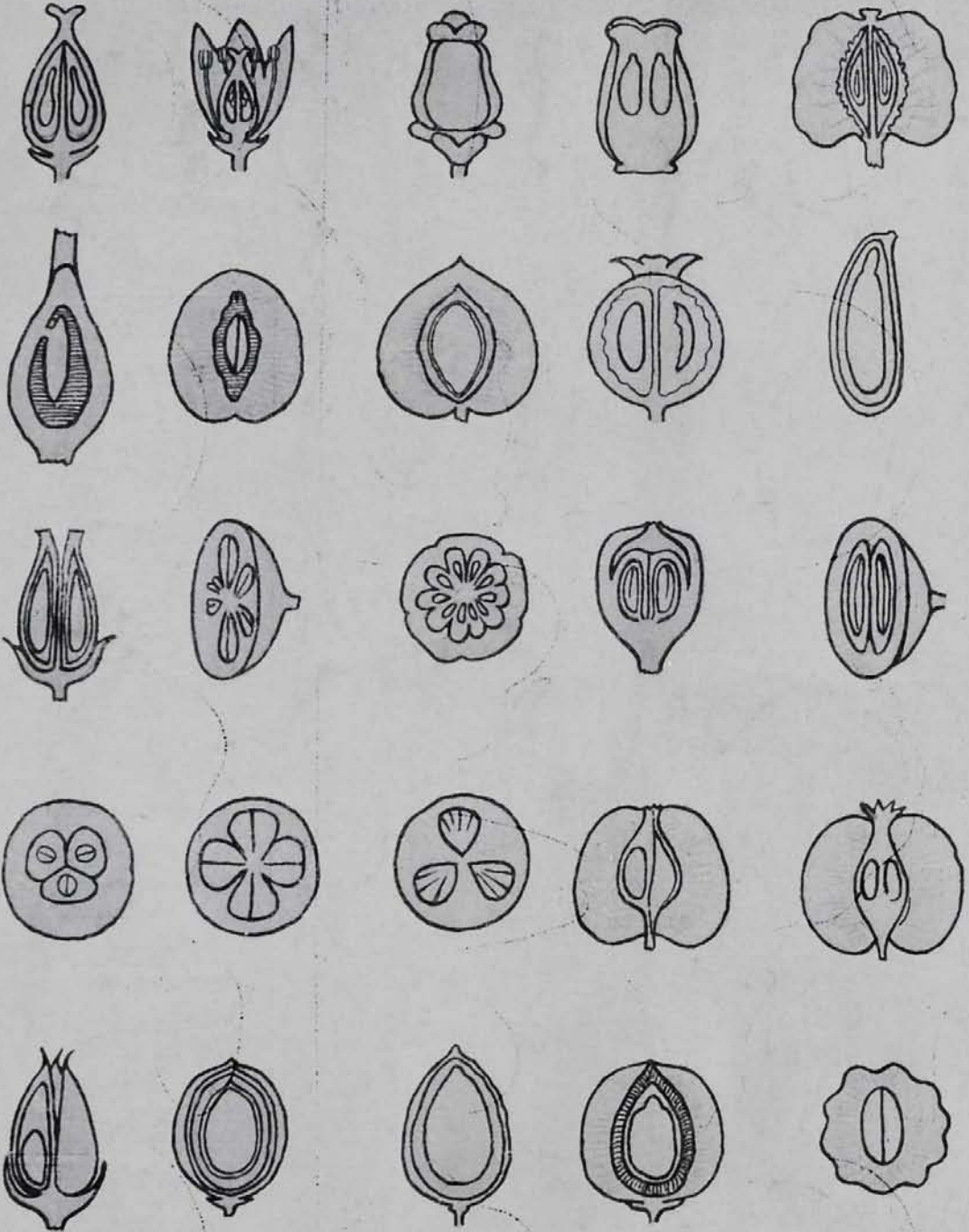
FLORAL FORMS



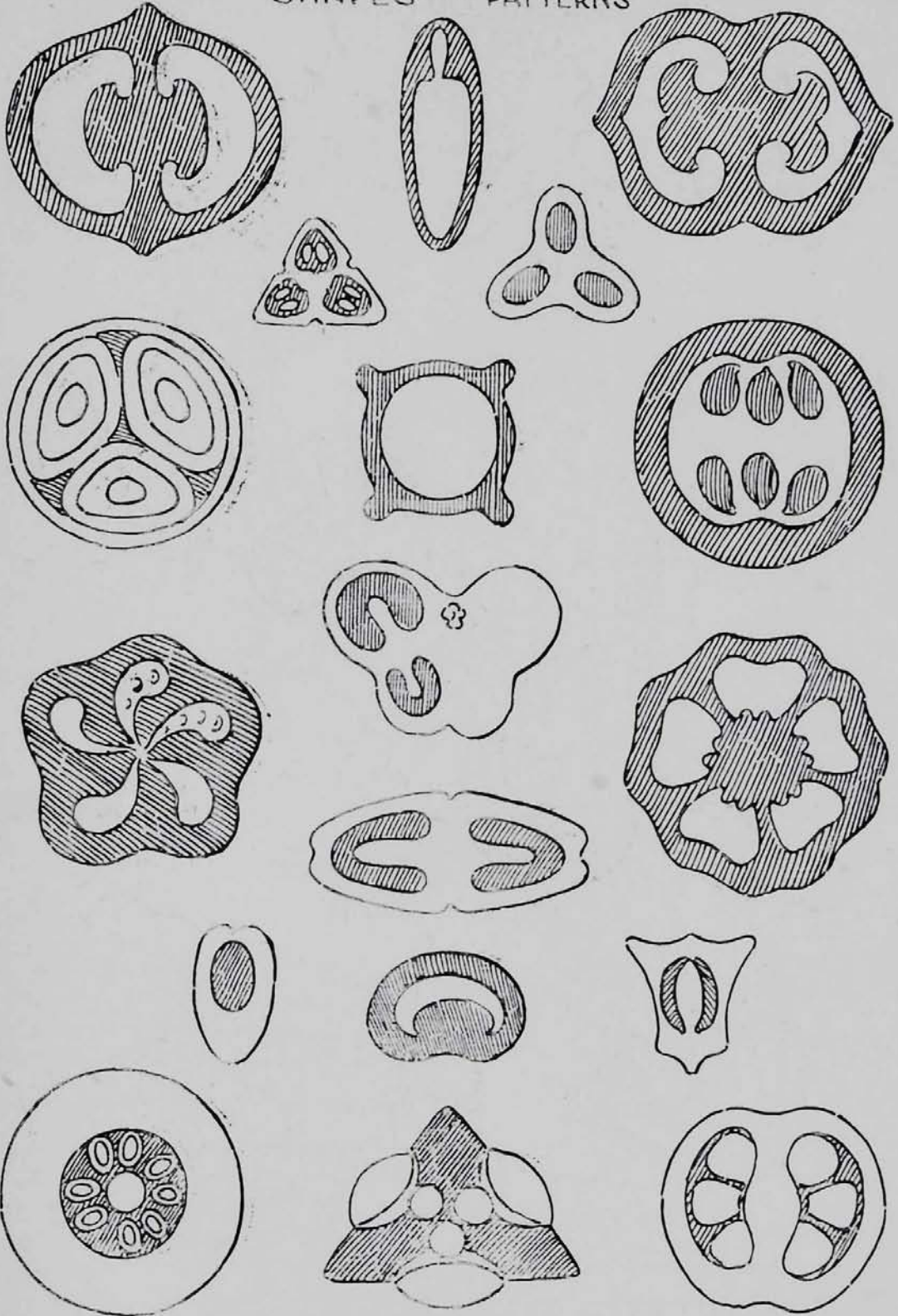
BUD FORMS



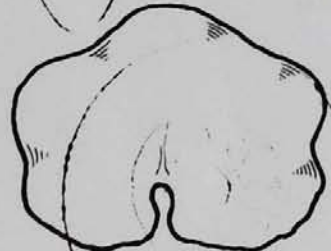
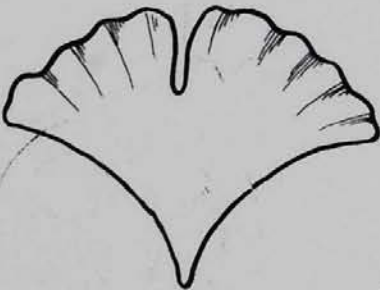
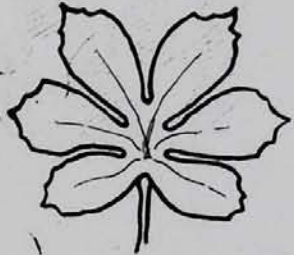
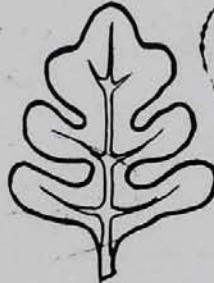
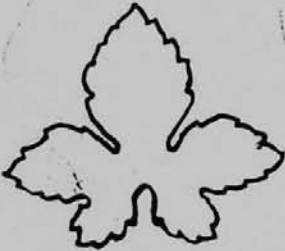
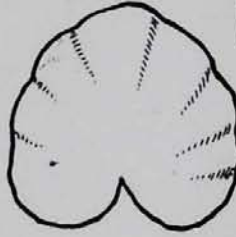
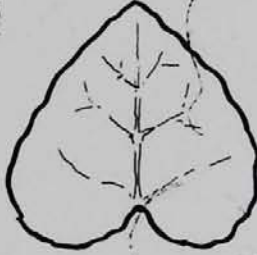
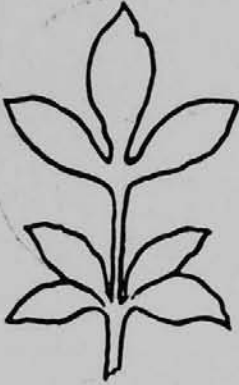
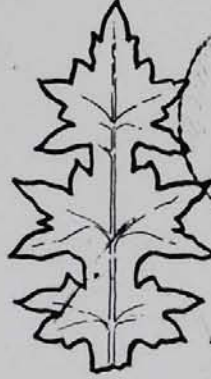
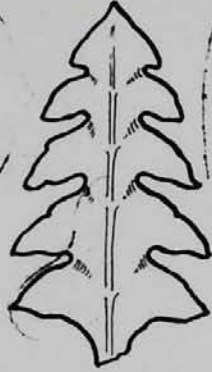
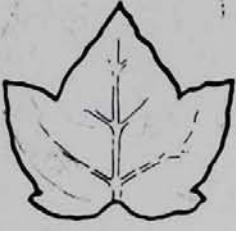
SECTIONS OF BUDS

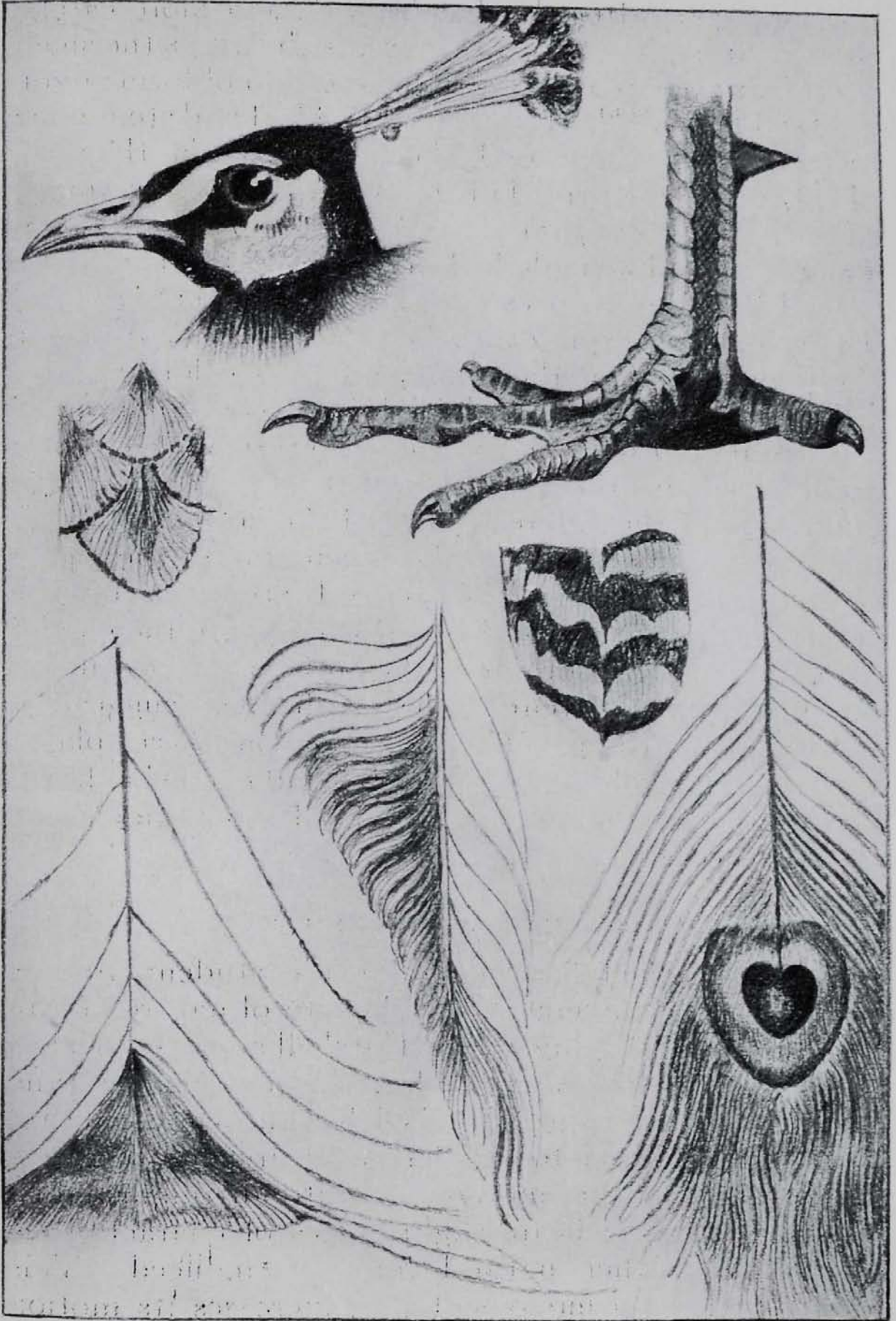


SECTIONAL DRAWINGS OF VEGETABLES AND SEED PODS
LIVING
SHAPES AND PATTERNS



LEAF OUTLINES



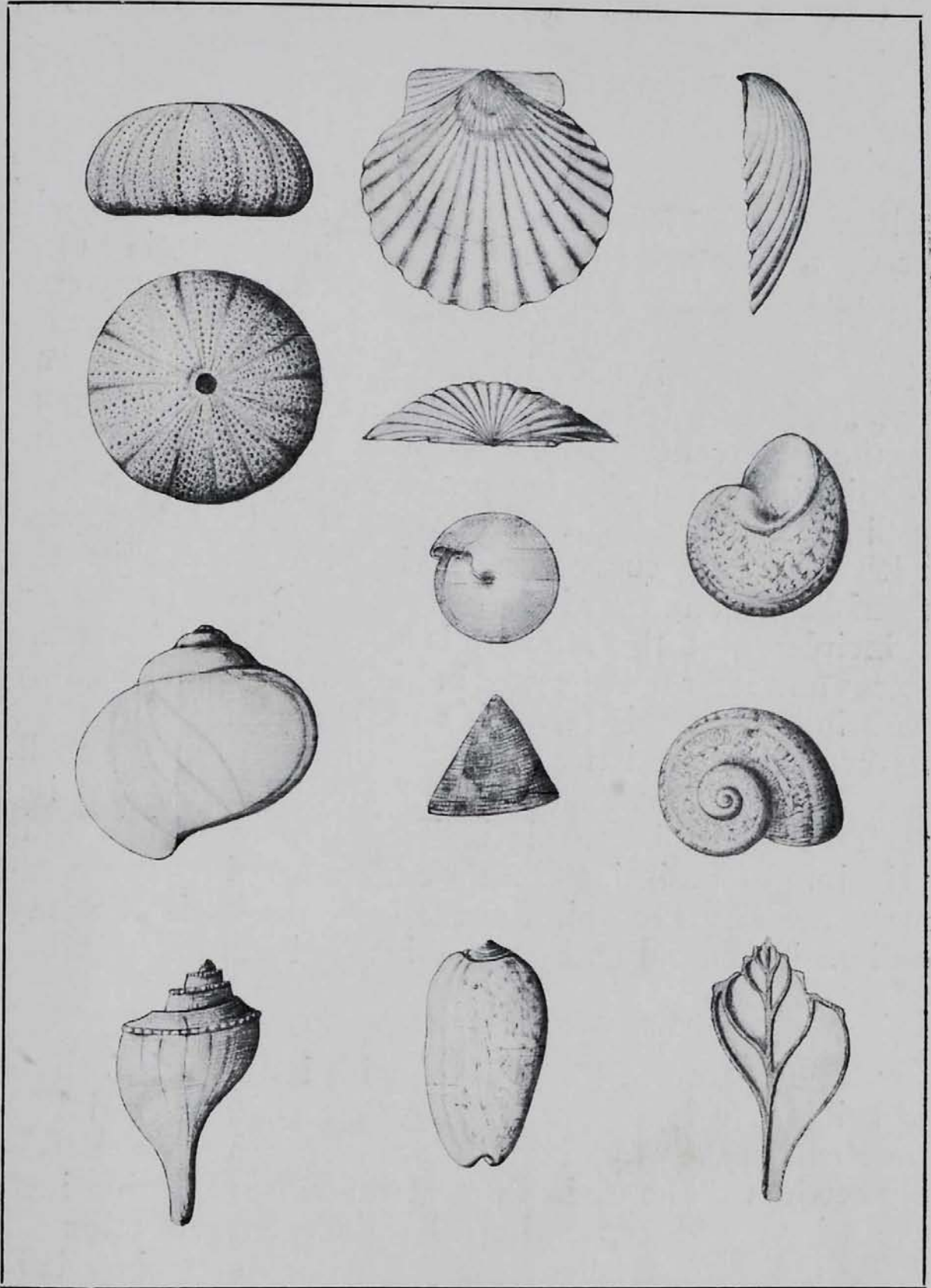


When it has been decided just how the stem is to cut the area it should be recorded by sketching its position on the paper; after this has been done a more careful drawing is made. Like previous line drawings the shadow side is accented to give it a suggestion of form or volume as Plate LVII. The structure of leaf and stem must be carefully made note of, the turn of petals, the swell of calyx, and the spread of stamen, for all this is knowledge that the designer must have ready at all times. The contour of a single leaf or flower bud as shown by Plate LVIII, are quite essential as suggestions of shapes. The color of the spray may be recorded by first inking the pencil drawing then filling in with color as Plate LVIIA. Plates LVIII to LXIII are continuations of this exercise except that the structure and contour are limited to the flowers and leaves. A thorough knowledge of the different parts of the flowers is highly important since this is the most interesting part of natural motives. The general structure of the petals on the torus, the shape of each petal, the curl of the calyx and the contour of the bud should be studied carefully from different angles, with some suggestion as to its modelling. The drawings on these plates have just enough line shading to indicate the form. Plate LXIV shows a careful study of interesting parts of the peacock.

DRAWING FROM SHELLS

The sea-shell has much for the student who is endeavoring to understand the beauty of nature. Plate LXV shows interesting views. The shell and the spiral so characteristic of many shells have been used from time immemorial in design, the shell having a charm that causes the observer to wonder at nature's exact work.

Sometimes the motive is quite distinguishable, while at others it bears slight traces of characteristic curves with other natural forms introduced. This spiral possesses a movement that increases its motion as it seems to wind to the center. It should be copied



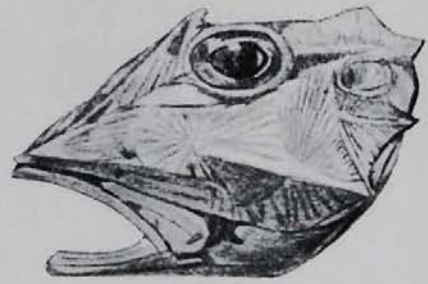
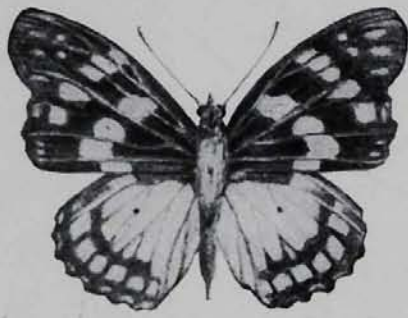


FIGURE 189

with the greatest exactness and precision. Other shells as the scallop are characterized by lines radiating from a common point. This shell has been used in every conceivable position and applied in many forms of decoration. We find it used in metal, wood, clay, iron and paper as decorative ornament. It served its purpose in the early centuries as a spoon or receptacle for holding liquids. The rhythm produced by its lines as they radiate right and left of a vertical axis, interrupted with a counter curve concentric with the outline has furnished many motives for decoration. These are principles that the student is to seek in such nature forms and later make use of in his work. The best way to bring about this result is to make copies that show nature's characteristics exactly as they occur on the shell.

This is illustrated by Plate LXV. The cross-section shell represents lines radiating from a common line. This principle of radiation from a common point or a common line and the spiral curve form the basis of many designs in general and jewelry in particular.

DRAWING FROM THE BUTTERFLY

The butterfly, Plate CXV, with its beautiful spots of brilliant color seems to offer the same material as the shells in the way of order but in a much more charming setting. The main lines of the ribs, radiating into the wings and separating the delicate gradation of colors make an excellent study for symmetry since it is exemplified in its most perfect form.

The butterfly is rendered with a medium and soft pencil by first making a very careful outline drawing

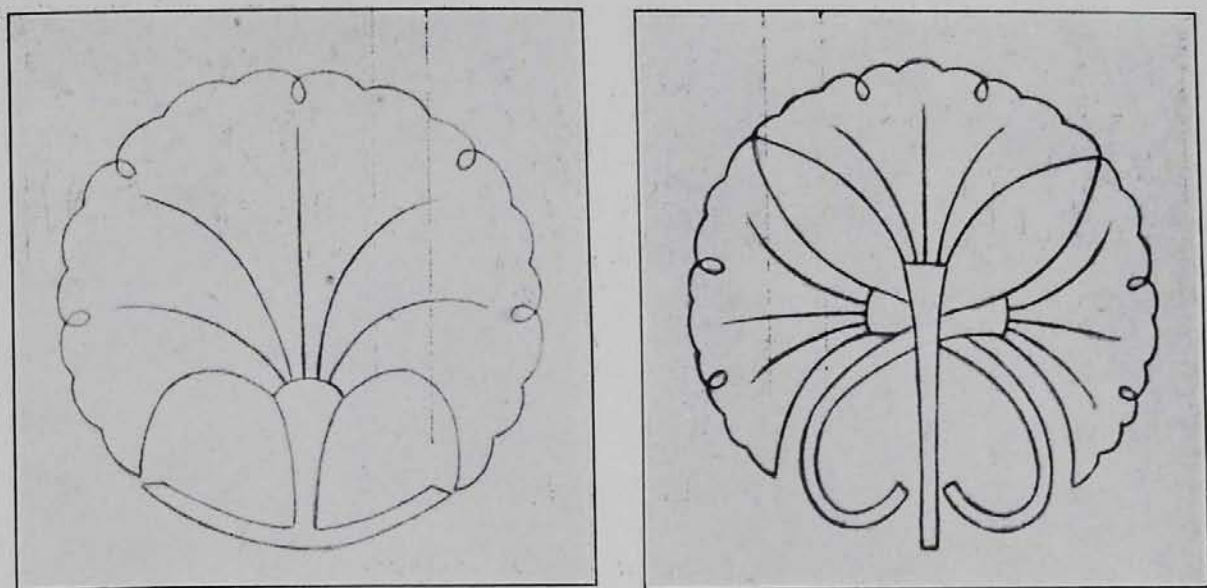


FIGURE 190

with the medium grade pencil. The shading is produced by laying on the darkest spots first then the next darkest and so on till the highest lights are reached. Care must be exercised when surrounding lights by darks not to diminish the light areas and to preserve the value for the ribs. For exercises of this nature the real butterfly is much more desirable than the colored photographic reproduction.

The fish drawing in Figure 189 is another excellent problem for pencil shading, exhibiting the order of lines and masses as they occur in this subject. The scales, fins, etc., offer not only light and shade work for pencil technique but interesting shapes which the student will regard with more importance later in the course.

JAPANESE CRESTS

Drawing thus far has been for technique primarily and incidentally to see nature from the designer's point of view. Later on the designer uses nature's laws in his own way emulating its beauty. Figure 190 shows fine pencil outline drawings of Japanese crests, illustrating the principles involved in the natural forms previously copied, i. e., lines radiating from a common point.

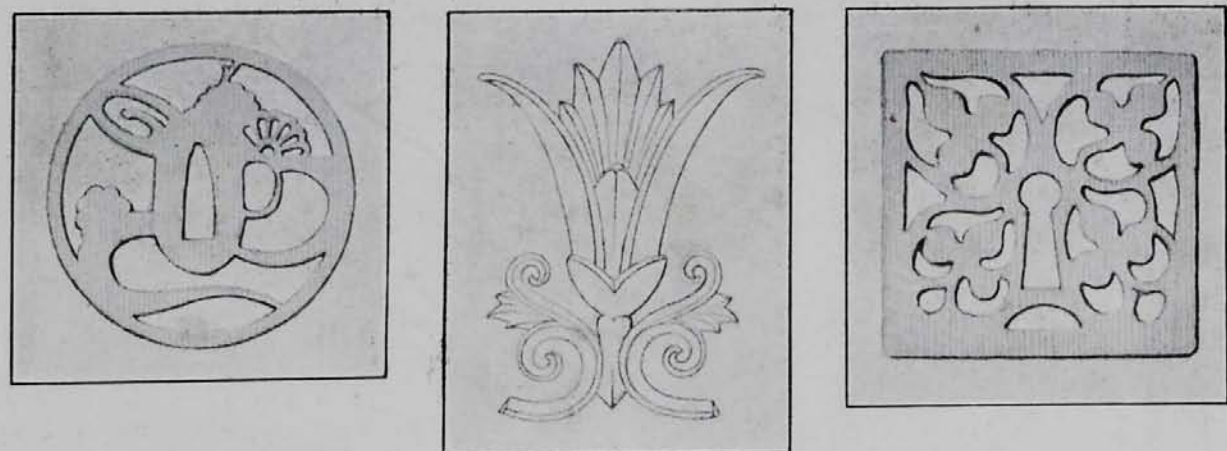
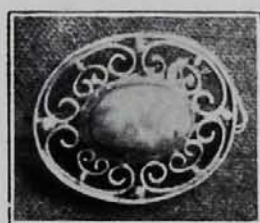


FIGURE 191

SWORD-GUARDS REDUCED

The drawing now is being reduced to a small scale. Figure 191 shows a sword-guard, cast, and an escutcheon, which are drawn in $1\frac{1}{4}$ " squares. This requires keen judgment for relative areas and lines. It calls forth the ability to carry mentally the measurements from the casts to the drawing in a reduced proportion. The quality of line shown by these figures is approaching the kind that is necessary for jewelry technique. The assurance of confidence that is expressed in every line must be bold and accurate in no less degree than other drawings done on a larger scale.

The exercises chosen for this stage of the work should possess delicate and extremely fine relations of space areas, examples that set forth the principles of sequence, balance, and harmony in a fine manner. The copying of such designs will inculcate a fine "curve and space sense" if we may call it such, and will serve its purpose when developing creative ability.



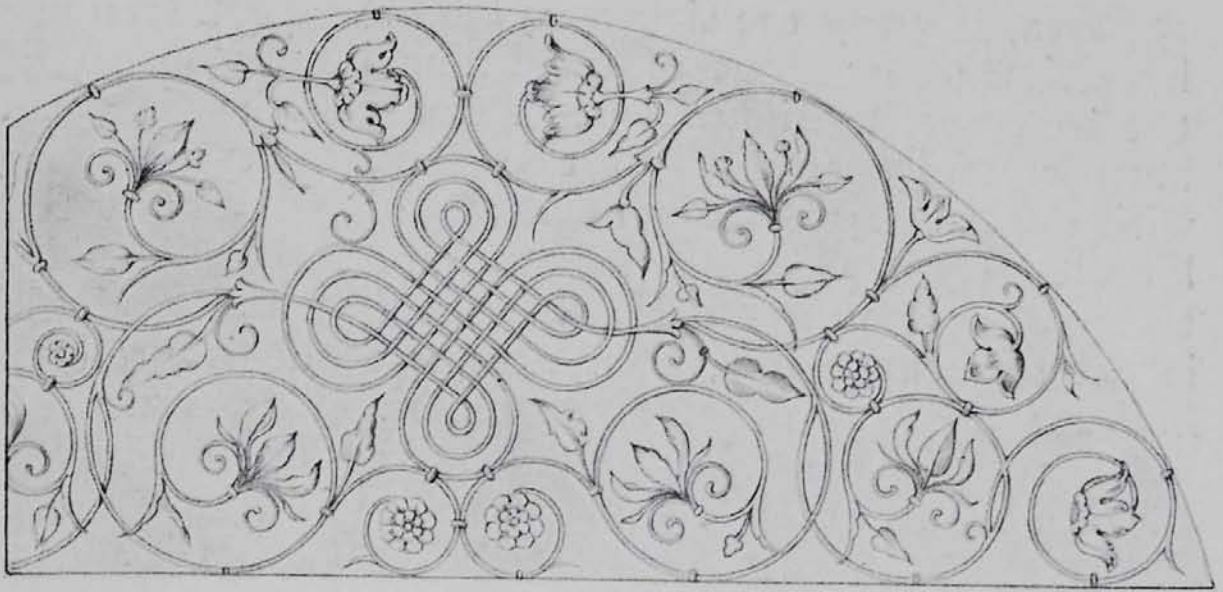


FIGURE 192

DRAWING FROM ORNAMENT

The drawing represented by Figure 192 is a historic example of a fine grill. This iron work furnishes excellent opportunity to study the application of the scroll found in the sea-shell and other motifs of natural origin. In historic ornament as in the Gothic iron work we find these scrolls running on and spreading out to the double branch volute from which leaf-like forms emanate; then we find the single scroll

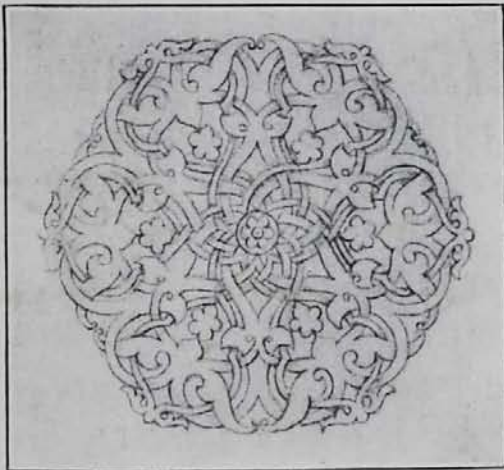


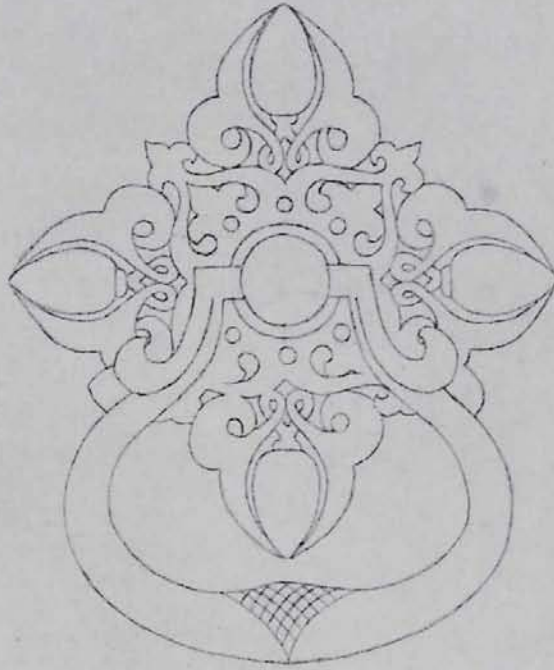
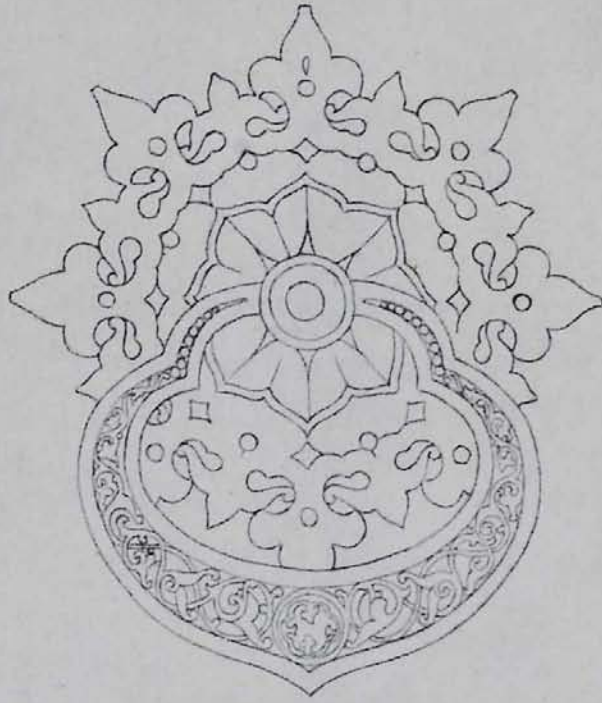
FIGURE 193

terminating in interesting rosettes. The Gothic iron work of the seventeenth century on chests, gates, and brackets still survives with its artistic splendor. It is quite essential to get the spirit with which the artisan of the guild worked by copying these fine examples with accuracy and precision, thus securing every little curve and bend of line.

Before drawing these, the attention should be directed to the manner in which these scrolls are distributed over

the area, the way the sizes vary and the small triangular units growing out of the branching scrolls to fill the space as in Figure 192. After the drawing has been carefully studied in this way, then sketch in with single lines the movement and distribution of the largest scrolls. The smaller ones are allowed to take their places and finally the smallest units. This is done in single line, then a double one is used to indicate the thickness of the metal. Care must be taken not to have corners or flat places on the curves and to represent that gradual increasing movement as they wind in on themselves. Metal lends itself in an unusual way for producing these finely proportioned curves as shown by this plate. It is hoped that the student will employ these characteristics when making designs for wire work later on in the course. Figure 193 presents an example of Saracenic ornament. Here again we have the running scroll, only in a mild form. The under and over effect here often furnishes many suggestions in design. In drawing a pattern of this kind, one that is divided into six equal sections, it is well to draw the circle with a compass and to divide it geometrically into six parts first. The drawing of the scrolls and units however should all be done free hand, first representing the main structural lines of the design with a single line. As in the previous drawing the design should progress from the larger elements to the smaller ones. It may be of help to use as many center lines as possible as this aids in placing the different parts of the design. When these have been located, represent them by a double line. After the design is carefully drawn, shade the dark side with a heavy line and cross-hatch the bands that run under for a little distance from the place of contact.

This will give it that sense of modelling sufficient to appear woven.



TRACING FROM HISTORIC ORNAMENT

Every student should have a scrap-book in which may be kept such examples as will suggest new ideas or inspire fresh thoughts. To this book the student may turn in the future to stimulate the artistic impulse. It is for economy of time and space that these examples be made on a strong, thin, transparent paper. Tracing from designs to add to the scrap-book or making tracings during the process of designing should be done all the time. Making good tracings with a clear and steady line, as those on Plate LXVI, is conducive to good pencil or brush work. The tracing is made by holding the paper firmly over the model and drawing with a medium soft pencil well pointed. The book or plate being used may be protected from abuse by placing a sheet of pyraline over it. The student should always be collecting designs, adding them to the scrap-book which, in a word, is the store house for suggestions and a great asset to the designer. Figure 194 illustrates such a scrap-book.

TO MAKE A SYMMETRICAL TRACING

Very frequently it becomes necessary to transfer a design from one sheet to another and more frequently it is necessary to make a perfectly accurate drawing of rough sketches. To make an accurate drawing of a figure that is symmetrical on either the vertical or horizontal axis is a tedious process if the pattern is very intricate, and it is more so when the design is alike on both axes. Tracing paper will not only save time but it will assure an accurate result beyond a question. It is quite important to use a good transparent paper and a fine sharp point on the pencil. To make a tracing, take a piece of tracing paper that is a little larger in area than the design. Fold the paper in halves by making a firm crease as Fig. A, Plate LXVIA; keeping the paper thus folded, fold again at right angles to first crease as Fig. B, making absolutely certain that

the first two half creases just coincide before the second crease is made. When the paper is unfolded there will be two creases at right angles as AB-CD in Fig. C, and four quarters, namely 1, 2, 3, 4. Make two diameters on the design to be traced as in Fig. D; now place the tracing paper upon it so that the diameters of the tracing paper and those of the drawing will just coincide. While holding it down firmly trace on the first quarter as Fig. E. Now fold on AB as Fig. F, so that the drawing is on the outside of the tracing paper, then trace the design by drawing on the second quarter of the tracing paper as Fig. G. Next fold on the diameter CD as Fig. H and trace the half already made upon the third and fourth respectively as Fig. I. The drawings of the four quarters when complete should be on the same side of the tracing paper. It will be noticed that the design has really been traced three times from the original drawing of the first quarter.

If the work is done accurately with a medium grade pencil, well pointed, the result will be perfect. Now that a perfect drawing is obtained it can be transferred to wherever desired by holding the tracing down, with the graphite lines next to the paper to which the transferring is to be made and marking over the same lines of the drawing. The transferring may also be done by rubbing over the tracing with a coin in one direction only, and that is always away from the worker.

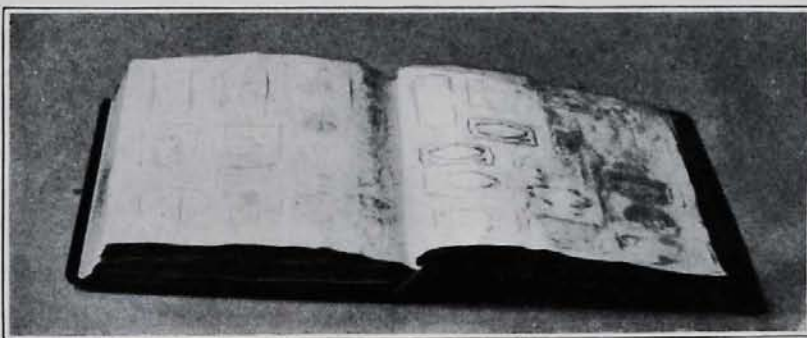


FIGURE 194



FIGURE 195

The former exercises were introduced to acquaint the student with such nature forms as are used in design in general and in jewelry design in particular. The subject chosen illustrated nature's order of growth, the systematic repetition of spots of exquisite color and beautiful curves. Later historic examples were presented showing how nature's laws were used by man, and the designs attained as a result of following nature as a guide. This line of thought has familiarized us with many ideas of shapes and forms which

in turn are capable of suggesting many more. The examples used have not as yet been jewelry designs, but mostly of iron work, nevertheless paving the way for the smaller and more jewel like subjects. Figure 195 represents a fine example of a pendant. It is executed with a soft pencil on a paper with a fine texture. The jewelry designs are introduced for the sake of gaining a knowledge of the possible contours and the relation that the stone bears to the general character of the ornament. A knowledge of forms and shapes together with the facility developed with the pencil as a mode of expression serves as an excellent foundation upon which to build. The rendering of this problem is considered under the chapter of rendering in black and white in pencil.

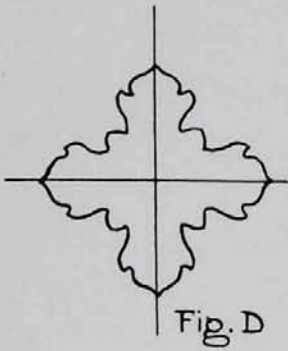


Fig. D

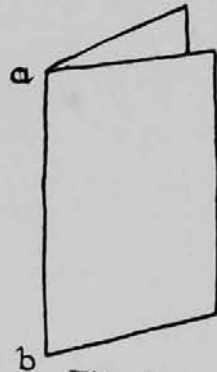


Fig. A

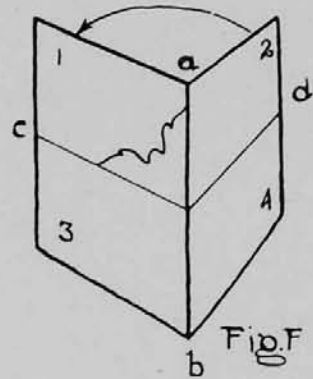


Fig. F

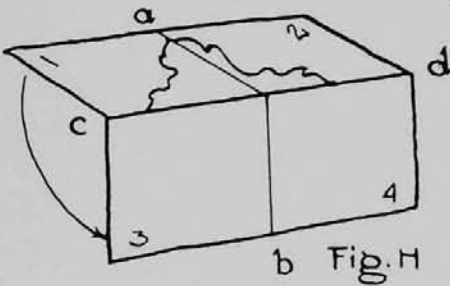


Fig. H

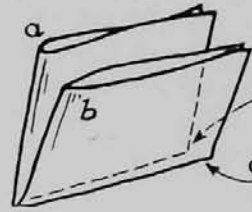


Fig. B

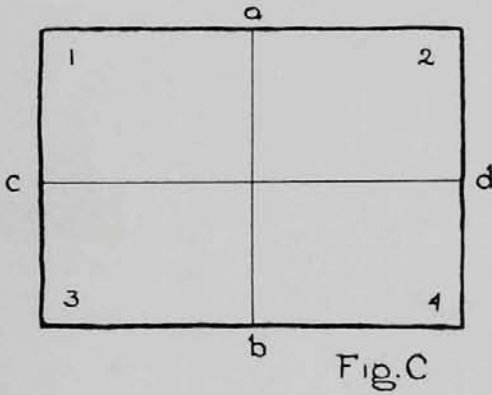


Fig. C

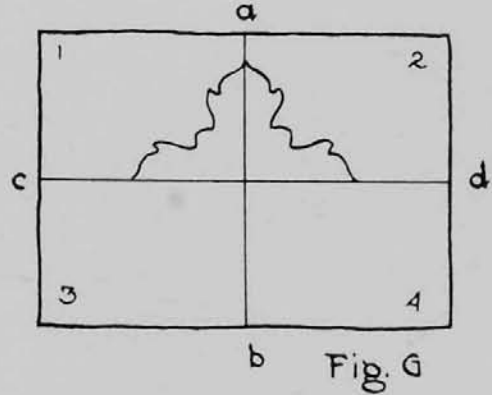


Fig. G

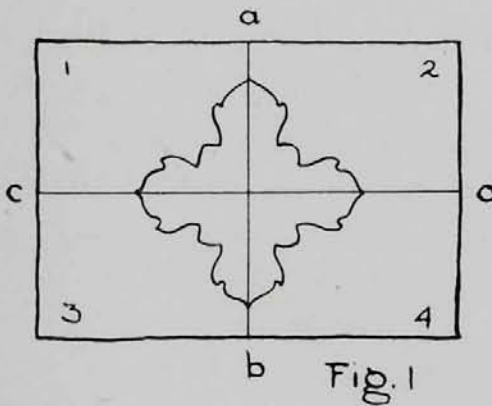


Fig. I

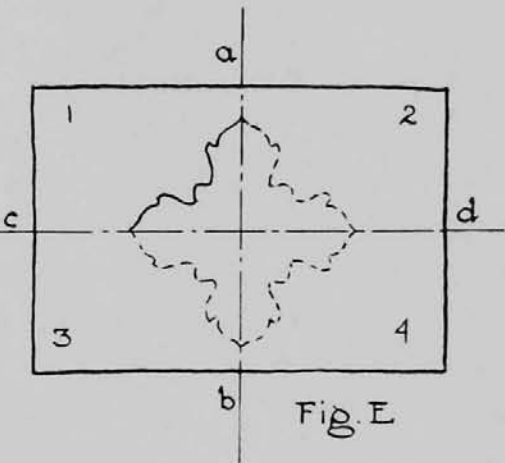


Fig. E

Chapter XXIV

Historic Ornament

"I do not think any man but one of the highest genius could do anything in these days without much study of Ancient Art, and even he would be much hindered if he lacked it."

WILLIAM MORRIS

WHEN the character or quality of an ornament of the past can be identified according to the methods and motives employed and to the race or nation that produced the ornament it is called historic. The three most important styles of historic ornament are the Egyptian, the Greek, and the Roman.

A knowledge of the different styles of ornament forms an excellent basis not only as a means of identifying the work of past generations but also for the material it furnishes for new thought. Our predecessors have handed down to us a vast amount of expressions in things beautiful. It remains for us, their posterity, to add to or modify this inheritance in the light of our own time. When coming into possession of the social experiences of the past, it is expected that we contribute our share to its wealth for having made use of it. The ornament of a past generation may be translated into a modern language possessing the spirit of a twentieth century people, but the knowledge derived should ultimately give birth to a new inspiration, if not *quasi* new expression. By so doing we contribute to the wealth accumulated by social expression. It is not expected of any generation to copy the people of the past. For the occidental to endeavor to transfuse the Japanese spirit into his design would be as impossible as actually to try to be the Japanese

himself. All that we can successfully accomplish is to render an interpretation of an oriental motive in an occidental manner. Art or decoration is always the expression of a living people, the reflection of their thoughts and deeds.

By the hieroglyphics of the ancients that have survived we are able to discern their philosophy, their religion, and their culture. In this way we are able to determine with a fair degree of precision the height of their civilization. In the work of each nation we find certain general characteristics dominating their decoration. Most of the elements can be traced directly to nature while others show evidence of being founded on geometry. The moon, stars, planets, rivers, vegetable, plant and animal life, were used by the ancients and held as divinely sacred. Carefully studying these designs or making facsimiles as illustrated in this chapter will be invaluable to the student of design.

There are three advantages to be derived by making copies of historic ornament. The first is the

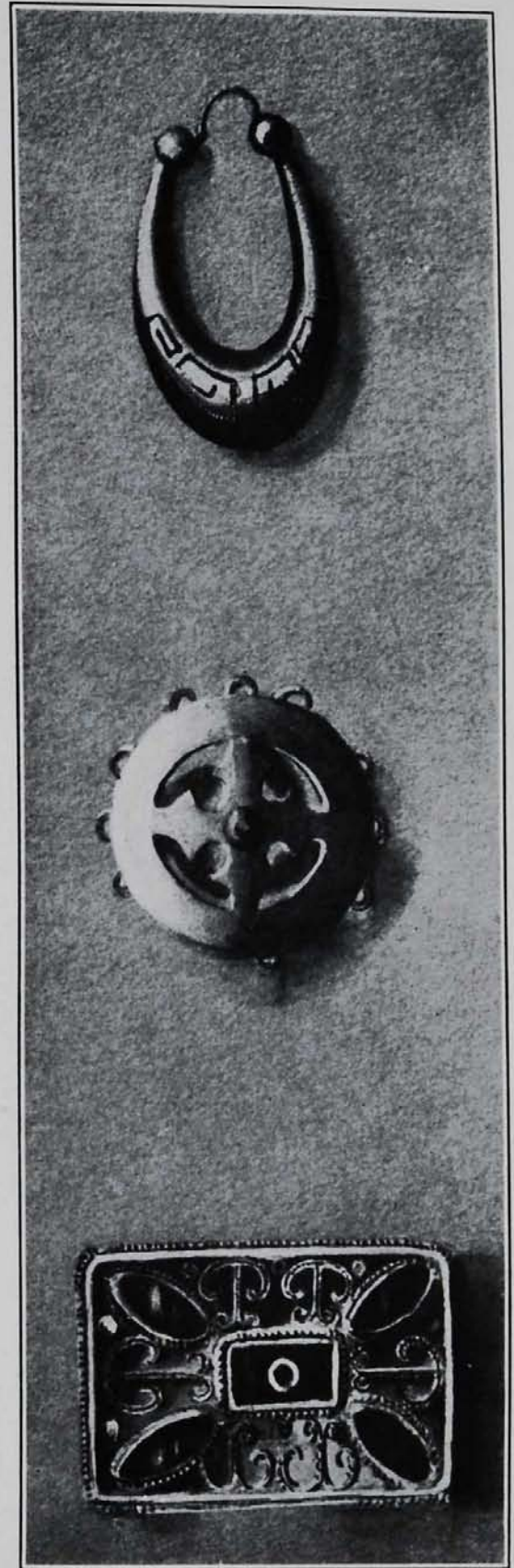
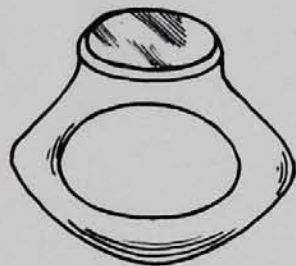
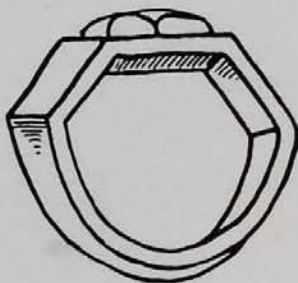
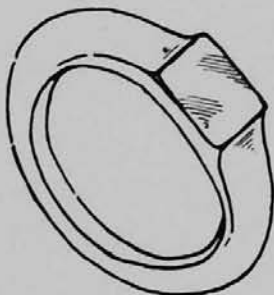
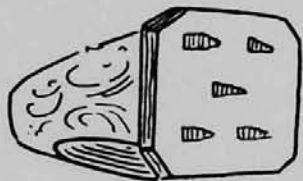
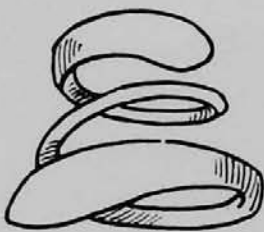
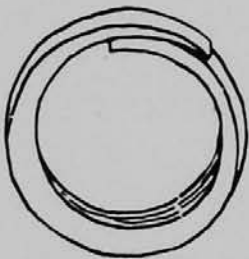
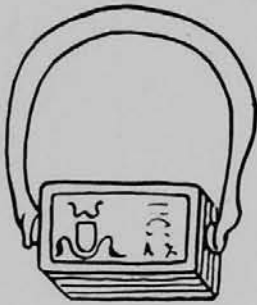
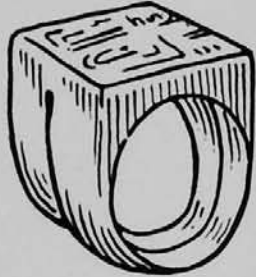
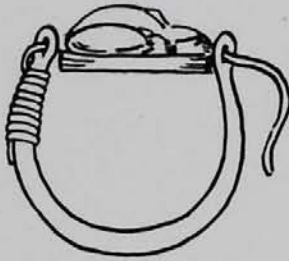


FIGURE 196

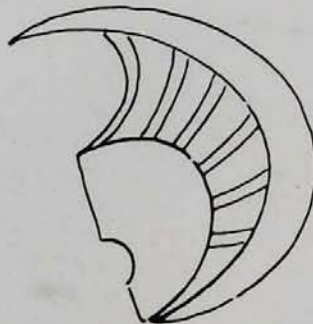
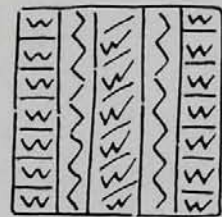
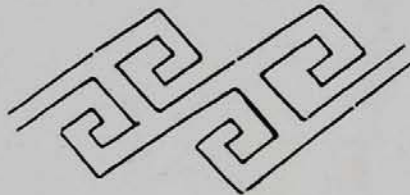
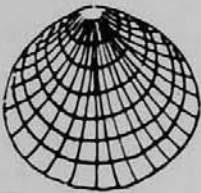
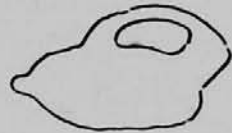
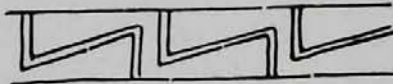
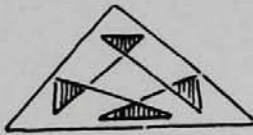
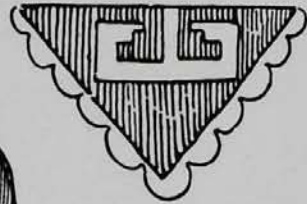
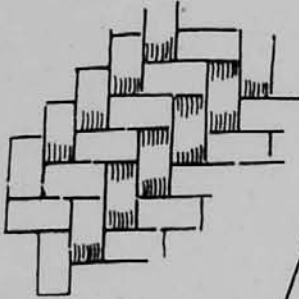
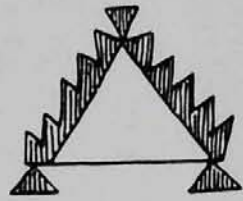
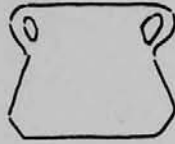
HISTORIC RINGS



development of appreciation. The principles of concentration, subordination, rhythm, balance, harmony of line and color, and symmetry are revealed as the ornament is studied and copied line for line. The changes that the same motive went through as it was adapted to different purposes clearly sets forth the principles governing conventionalization. A clear understanding of the way that these principles and laws were used develops the sense of appreciation for art in general and increases the ability to create new forms. The second benefit derived from copying is the ability to identify the different styles of ornament. By choosing examples that are purely characteristic of the style, a vivid impression is made on the memory because of having executed the design in line, dark and light, and perhaps color. The transition from one style into another is a slow and subtle one; the line of demarcation is always very obscure, hence the motives used by one generation in their design may be so transformed by a succeeding one that the identity of the former style is entirely lost. If enough copies are made so that the impression is permanent the style will be easily recognized in the future and can even be reproduced at will.

The third benefit, but not the least important, is that of using it for modern purposes. Styles, fashions, and ideas of the present are merely revivals of the past, or at least modifications, conforming with present institutions and processes. If our decorations cannot be identified with those of the past they at least bear traces of resemblances to several periods. We translate the ornament of the past in terms of modern expression and conditions. A clear understanding of each style will enable the student to design intelligently and consistently any particular period. It enables him to blend with the borrowed forms others of his own ingenuity or so to vary the motives of the period chosen as to give rise to a new ornament.

MUSEUM SKETCHES
OF HISTORIC ORNAMENT

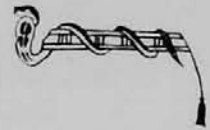




HUNGARIAN NECKLACE

Set with one hundred and twenty stones and enamel, consisting of pearls, emeralds, rubies and sapphires.

EGYPTIAN ORNAMENT



Principles of Jewelry Design

ALTHOUGH there are many principles of jewelry design the six that are considered here are first in importance. They are, Fitness to purpose, Unity between stones and ornament, Conformity with personal characteristics of the wearer, Conformity with costume, Nature and distribution of ornament, and Possibilities and Limitation of metal as a medium of expression.

FITNESS TO PURPOSE

Every piece of jewelry must be designed to fit its purpose. Some pieces like the brooch, clasp, buckle, scarf pin, cuff links, and hat pin, may be designated as useful since they serve the purpose of a fastening for clothing. The ring, head ornament, pendant, bracelet, armlet, earring and la valliere, are used merely for personal adornment. As the savage used paint and tattoo to call attention to certain parts of the body, so people of modern times use decorative jewelry. The ornament on useful jewelry is secondary to its practical value while that on decorative jewelry is of primary importance. Whether the piece of jewelry serves a useful or aesthetic purpose primarily or secondarily, it must fit the purpose for which it is used. It must be of such a nature as to conform to the surrounding conditions, must be duly related to the parts it is to adorn and must serve its purpose in an efficient way.

The ring is circular because it is to fit over the finger. For this reason it must be perfectly smooth on the inside and, as it is to come in contact with the other fingers, it must be more or less smooth on the outside. The stone must not rise abruptly or too

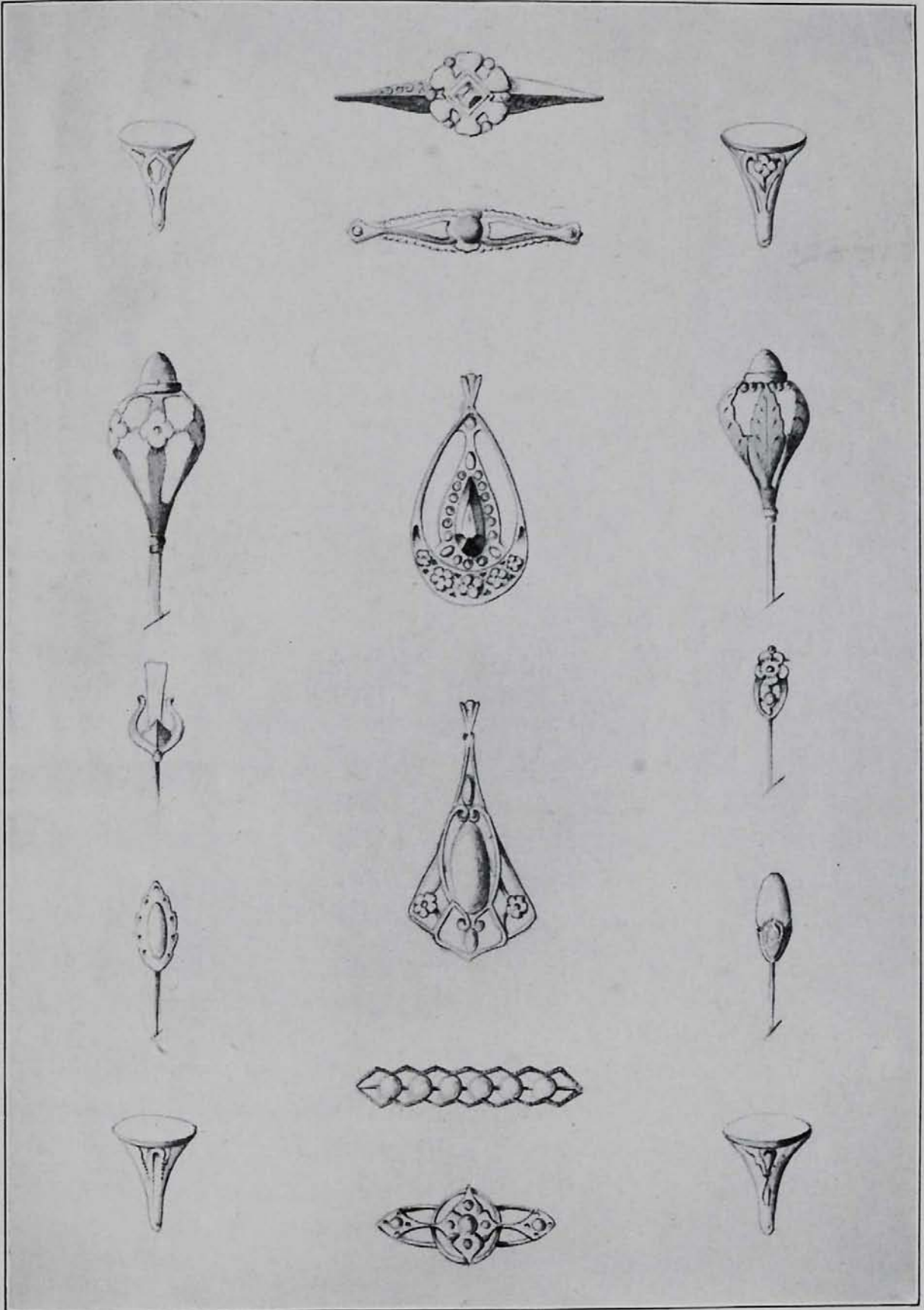
high above the shank since this would interfere with the freedom of the hand. The shank on the inside of the ring must narrow if the fingers are to close comfortably. The armlets and anklets, etc., which are for a similar purpose as the ring, require the same characteristics.

The brooch, which originally was used almost exclusively for holding together parts of the garment seems to have a place in the ornamental as well as the useful jewelry. It often serves the purpose of a button; for this reason its shape was round originally but now the contour has assumed various shapes. Since it is used to hold fabrics it must be free from edges that would catch and tear. It must be made strong enough to hold its shape at all times.

The pendant, necklace, and *la valliere* which are worn about the neck and hang over the breast are made up of one or more movable parts suspended on a chain. The pendant is worn over the waist and must therefore be of a conspicuous size while the *la valliere* is a delicate jewel pendant and worn with a low neck waist. The gem is usually a small brilliant. It is sometimes used with a chain just long enough to go around the neck and to allow it to hang at the throat.

THE NECKLACE

The necklace is composed of jeweled or enameled units connected by one or more chains; some hang in festoons making a lace-like pattern on the breast. The jeweled units are often graded toward the ends from a pendant hanging in the middle. Necklaces are very frequently set with precious stones and bright enamel. The stones, when graded, produce a rhythmic effect of color. The lace effect is produced by a net work of chain giving a rhythmic movement as it recedes from the central feature. In any case the areas enclosed by the chains should receive careful consideration by the designer. The curves, which apparently



begin and terminate on the main line of support repeat themselves with decreasing or increasing wave-like movements as they lead the eye around.

GIRDLES, CLASPS AND BUCKLES

Girdles, clasps and buckles have a practical rather than an ornamental use. The clasp is made of two pieces, one connecting the other by means of a hook. The buckle was formerly made up of one piece, but is now made of two, and has taken the place of the clasp. The buckle as a clasp is made of two pieces, one piece having the hook and the other having the space to receive the hook. It is so designed as to make it difficult to discern the two separate pieces. As it often comes in contact with cloth the contour is usually extremely simple. A very common shape is one that is wider horizontally than vertically. This shape carries out the effect of the horizontal pull. It is made of rather heavy metal enabling it to keep its shape and form, when subject to strain.

THE SCARF-PIN

The scarf-pin is used to keep the tie in place. While the head is ornamented and attracts attention to the tie it also keeps it from coming out because of the angular bend of the pin from the head down. As pressure is brought to bear on the pin it must be of sufficient thickness to withstand bending. Because it assumes a vertical position its design should be constructed to impart an up and down effect. The hat pin is much like the scarf-pin in principle. The head which is the ornamented part is usually a knob-like form and should be free from prongs or points. A stone is sometimes used as the central feature of the design.

THE CUFF BUTTON OR CUFF LINK

The cuff button or cuff link is a piece of jewelry that seems to be a necessity. It is made in various types; it may be a flat disc on the end of a thick curved

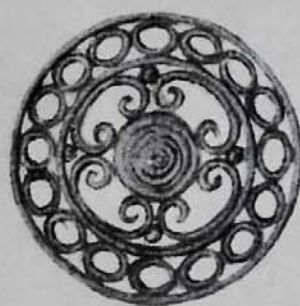
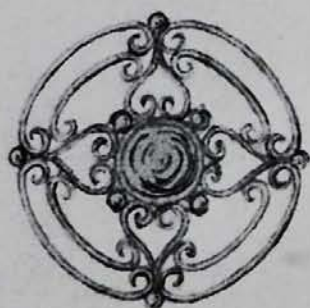
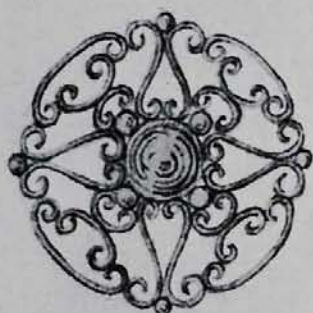
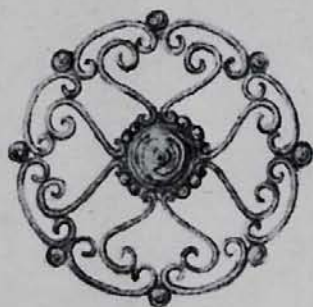
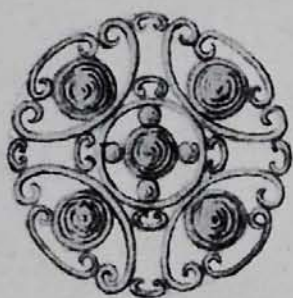
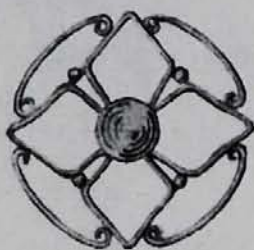
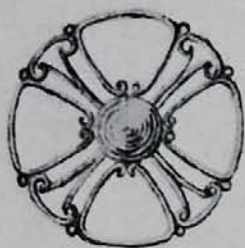
wire, with a bean on the other end, or it may be made of two discs connected with links. It is a necessity inasmuch as men's shirts are made without buttons or cuffs. The disc may be circular or elliptical or even square or rectangular in shape. The outline is invariably simple as it is to offer no resistance while it is being adjusted in place. Ornament employed should be low in relief, enamel sometimes being used. A stone or brilliant is sometimes set low in the metal or, if a large stone is used, it is of a low cabochon cut. The wire connecting the two parts is bent in order to bring the cuffs together at the opening.

UNITY BETWEEN STONE AND ORNAMENT

Many gems, beautiful in color and accurately cut, are very frequently ruined by being improperly mounted. The aesthetic value of a stone lies in its color quality. Some stones possess rich and intense colors while others are soft and quiet in appearance. The hardness, transparency or opacity of the stone indicates the manner in which it should be mounted. Stones that are soft and breakable must of necessity be mounted so as to avoid wear.

The cabochon cut stones seem to retain more of the natural qualities than the faceted so perhaps have more charm when used with hand-wrought jewelry. Whether faceted or cabochon this quality should be carried out in the design. When using stones that are light in color the student should avoid heavy or clumsy motives. The spots should be rather light, small and delicate in appearance. The ornament as a whole should be so treated as to heighten the quality of the stone, making it not only a part of the whole scheme but the dominant feature.

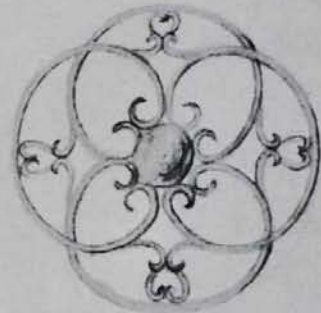
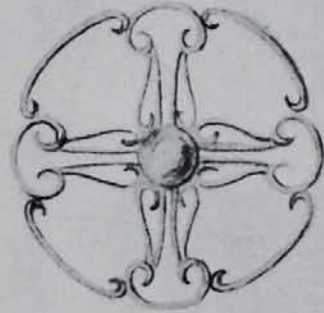
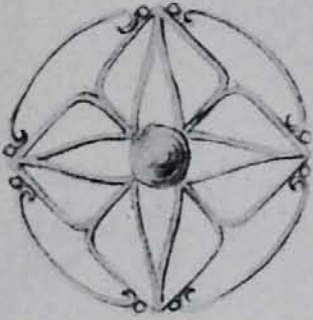
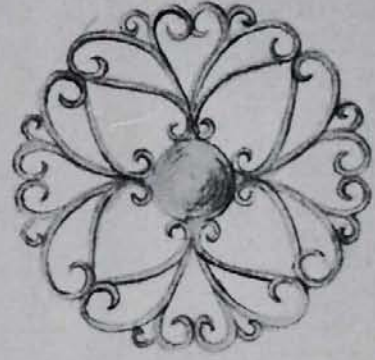
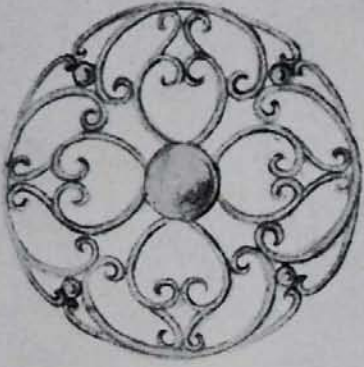
The mounting is a very essential element in jewelry. The stone should not appear to rise abruptly out of the metal but should make its appearance gradually in gracing the whole design. Some stones like the



faceted need to be set in prongs or in bezel settings since they demand much light to displace their color to advantage. Others, like the opaque and soft stones easily broken, must be protected by setting them low in the metal.

CONFORMITY WITH CHARACTERISTICS OF WEARER

Jewelry like other forms of ornamentation may be designed for either young or old and may reflect the personal characteristics of the wearer and even made to express bereavement. Jewelry should be designed to be in keeping with the physical characteristics of the sex intended. That for gentlemen should be much heavier in design, and carried out in a bolder form of ornamentation. The ring is the best example as a contrasting type since it is common to both sexes. The lady's ring is always of a more delicate or dainty character, although the stone may be large in size. The shank is invariably very narrow with little if any design. On the other hand the gentleman's ring ranges from a medium to a large masculine size with a wide shank having more or less ornament. Men's jewelry today is much less like that of women than in the cavalier's time when both sexes dressed lavishly with luxuriant laces and velvets. Jewelry may be designed to comply with the traits of all ages. For children it is not only of a small range but severely simple, possessing little if any ornament. Gems of value are rarely used in order that the charm and simplicity of child life may not be disturbed. Brilliant color effects of enamels and stones, richly ornamented with flowers, leaves and scrolls form the bulk of jewelry that appeals to the group that have come into the realm of appreciating the costly material. To this class the finely cut brilliants ornamented with rare and precious metal holds out many attractions. Then there is another kind of jewelry where the design is serious and serene, characterized by soft colors and



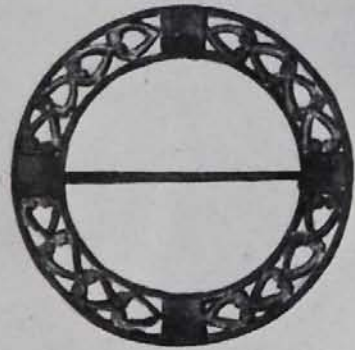
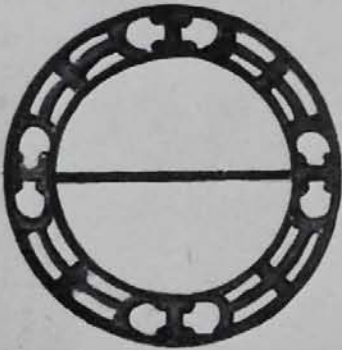
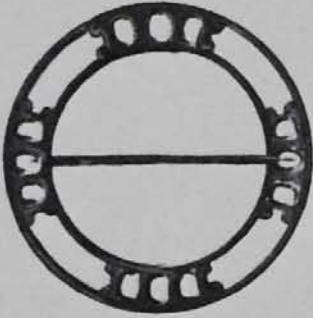
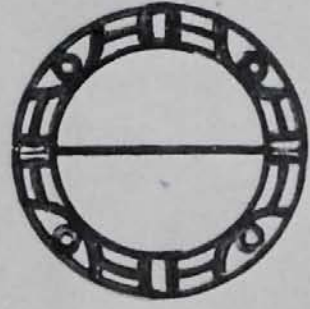
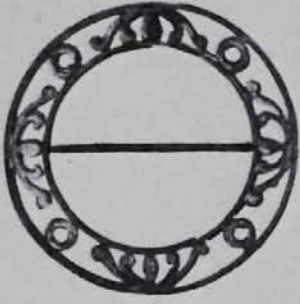
ornament that is more peaceful than active. The quality of stones are perhaps less brilliant and sparkling than those used for the younger people. Jewelry is even capable of imparting sorrows and bereavements of life. The design in most cases is of a straight line character with the customary black enamel.

CONFORMITY WITH COSTUME

In order for jewelry to make its appeal it must be attractive enough to challenge other personal ornaments. The design should bear out the characteristic features of the costume. Costumes like those worn on the stage must be seen at a distance, they demand jewelry that will have its effect under the conditions cited. The power of attraction must be secured by the glitter of highly polished surfaces and brilliants of various hues, so arranged as to harmonize with the gorgeous costumes. It should form part and parcel of the whole by permitting it to act as the key-note of the entire scheme. The kind of jewelry demanded by the peculiar conditions just cited, would be very inappropriate for civilian dress. The civilian uses jewelry of normal size, noticeable only at close range. Again the character of the design for this particular jewelry may be made to carry out the style of dress by an ornament that conforms with the costume. If the design is characterized by ornament that suggests action and life it will harmonize with a dress that is perhaps more elaborate. Whatever be the costume the jewelry should seek these qualities both in color and in quality.

NATURE AND DISTRIBUTION OF MOTIFS

The kind of ornament in a design is more important than even the manner of execution. Some natural forms lend themselves without reserve, especially those that have small forms and that repeat themselves with increasing or decreasing sizes. The leaf pattern with curling stems intersected by clusters of berries have



offered many pleasing arrangements. Straight line interpretations delineating shapes of finely related spaces enhanced by fancy wire or granulations have resulted in most dignified and pleasing patterns. Material that seems of little consequence like the tendril with its twist branching out into curl like lines has been used to develop the most charming and elaborate design. The spiral and the running scroll offers possibilities perhaps as no other motive. Whatever the motive chosen it must be in keeping with the character of the stone, and must be used so as to extoll its beauty. It must be so arranged as always to have the stone the center of interest. The interest of the motive may lead their forces to it gradually but surely, or it may be so arranged as to echo the shape in a concentric or eccentric manner. The motive should bear traces of unity by having a common element permeating the whole design.

LIMITATIONS AND POSSIBILITIES OF METAL AS A MEDIUM OF EXPRESSION

Every crude earthy substance or material that is capable of being transformed to a humanly useful object has its limitations and its possibilities. Metal is one of the few substances taken from the earth that is capable of unlimited transformation as is evidenced by various metallic objects in daily use. Gold, silver, and platinum may be rolled out into thin sheets or into the finest wire or may be made into almost any conceivable shape. These metals can be made into small forms or into granulations of minute sizes. They resist deformation and at the same time yield to the blow of a hammer, which makes them rank supreme among metals. Fortunately these same metals are capable of receiving enamels to a much better degree than others used more extensively for commercial purposes. However, because these precious metals permit themselves to assume any form it is not

in accordance with the principles of the fine arts to abuse this privilege by so treating motives as to have natural ornament assume a realistic appearance. Natural forms chased on the metal must assume a bas relief effect, thereby retaining the flatness of the plane if they are to achieve their greatest beauty. Pierced work should not be so delicate as to cause the design to be weak or the article to resemble lace-like patterns.

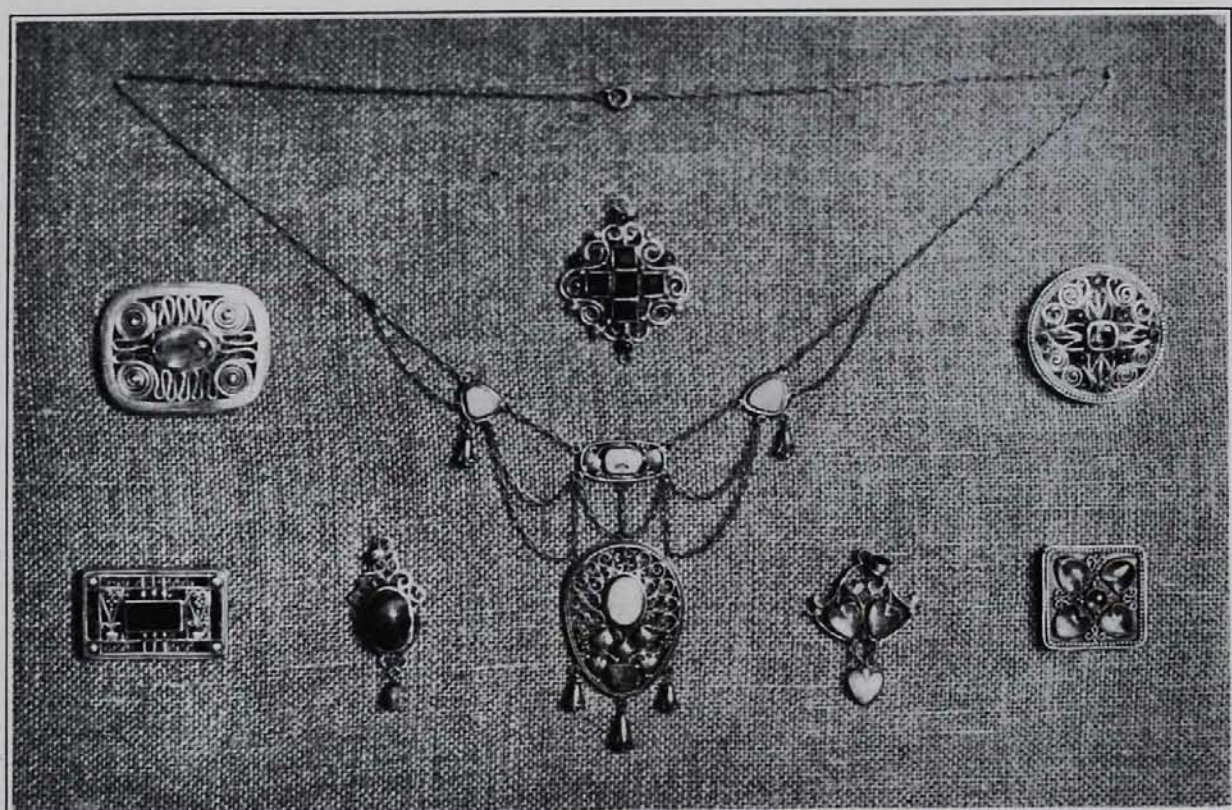


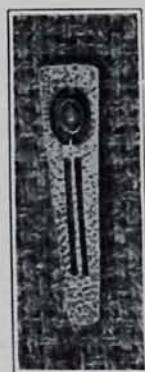
FIGURE 197

Chapter XXVI

The Beginning of Design

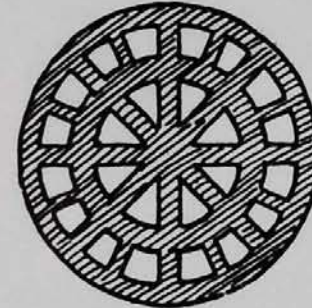
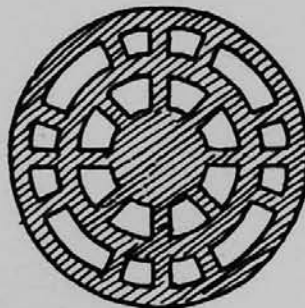
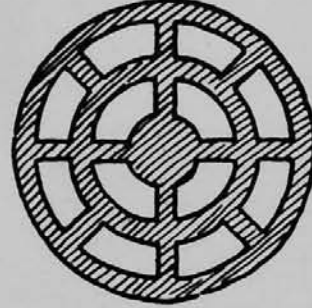
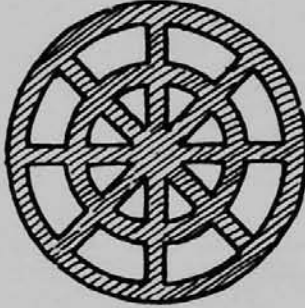
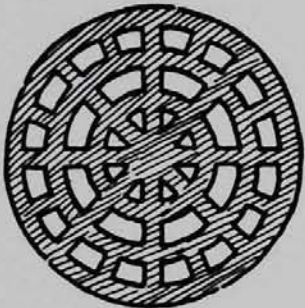
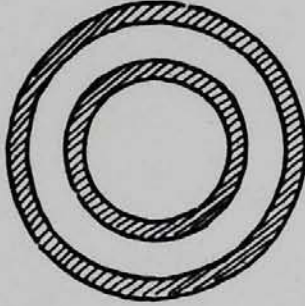
VARIATIONS

AFTER the student has made several drawings from various natural forms such as flowers, shells, beetles, or butterflies and from these has passed on to making copies of ironwork and jewelry in order to understand the limitations and possibilities of metal, he is then equipped with material fundamental for design; but he has not as yet the knowledge necessary to guide him in his endeavor to use natural forms in a decorative way. Even with a most complete and elaborate storehouse of forms and shapes gained from copying one cannot expect designs to come freely and easily. It is quite evident that there is a gap which must be given due and proper consideration. The gap between copying designs and creating them is wider than was expected. If this gap is not bridged by some means by which the student can easily make his way across from the ability of imitation to that of creation he will find that his efforts will be unsuccessful at the very outset.

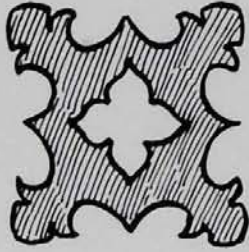


There seems to be no better way of bridging this space than by the problem of variation, which lies just between imitation and creation; it takes the work up where copying ends and carries it across to the point where creating begins. Every effort should be made to concentrate the attention on changing the copy even to the extent of sacrificing the technique, in order to obtain a variation of the theme. Making something different from what we already have before us, yet

BEGINNINGS OF DESIGN
VARIATION PROBLEM



COPY



VARIATIONS



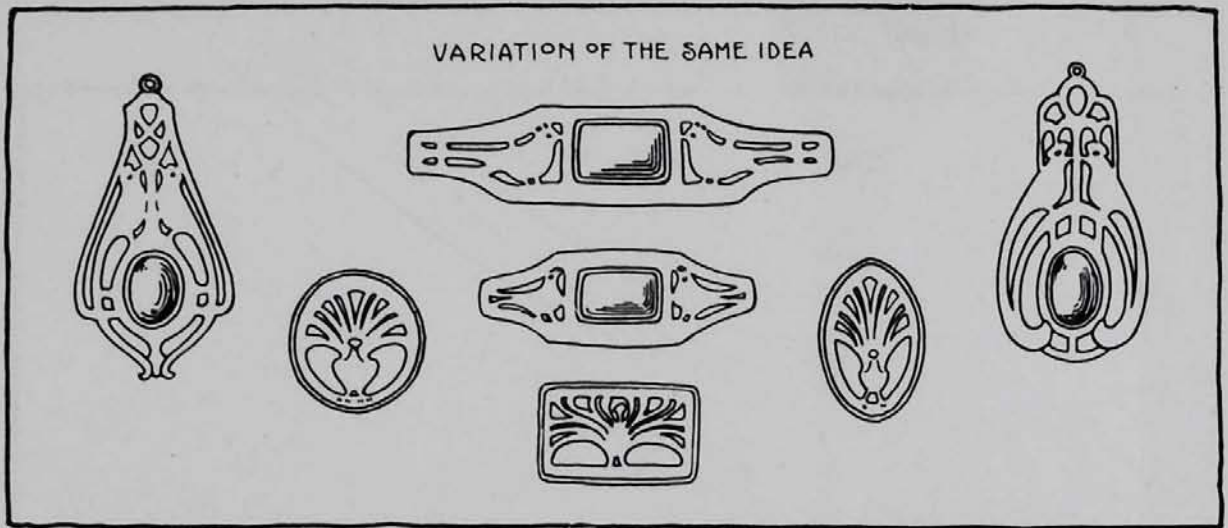


FIGURE 198

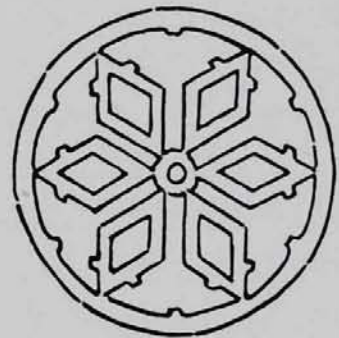
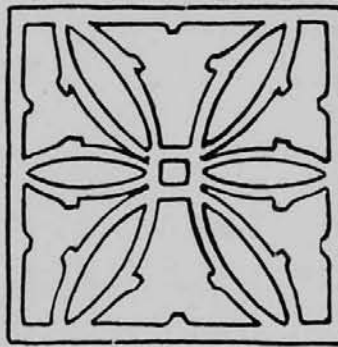
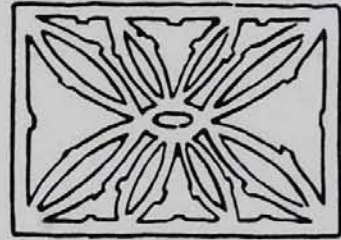
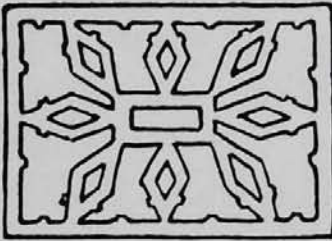
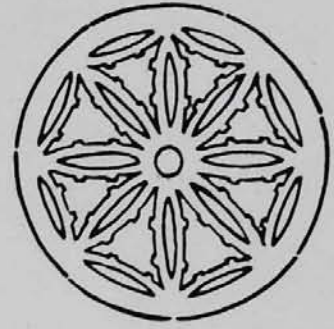
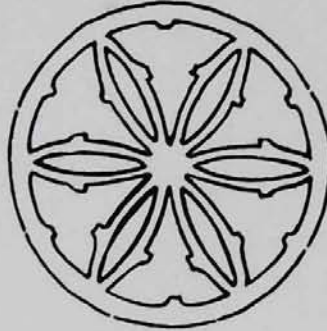
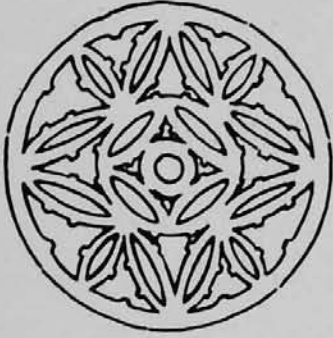
embracing the characteristic features of the copy is of paramount importance, irrespective of the practical result. To do this with facility, and in order to record the variants quickly, it is a good plan to do the designing in masses with brush and ink on a large scale before a more careful drawing of the normal size is made with the proper medium. There is no better way to gain a comprehensive knowledge of variations than to imagine a design on a piece of thin rubber being stretched either horizontally or vertically and to note the changes that take place. It is evident that the motive retains its characteristic features notwithstanding the contortion to which the design has been subjected. When the student has grasped the idea that a subject can be varied as this illustration shows; namely, by changing the proportions or by making a straight line design in curve lines or vice versa, he is laying a foundation necessary for interpreting ideas for jewelry design.

To obtain an idea bearing traces of the original should be first in mind. The method of executing the variant thus obtained can be afterward easily modified so as to be brought within the limitations and possibilities of tools and process peculiar to the jewelry craft.

Variation forces the attention upon studying the structure of the design and the principles by which it

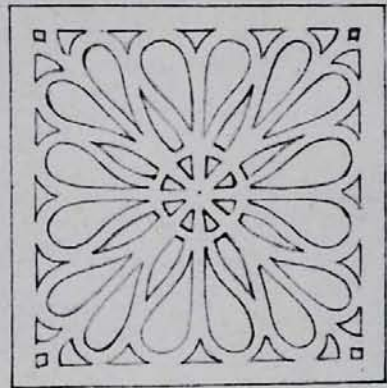
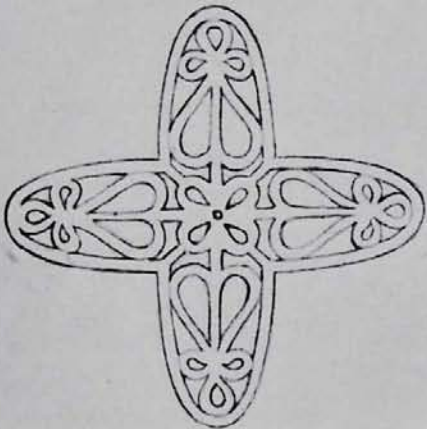
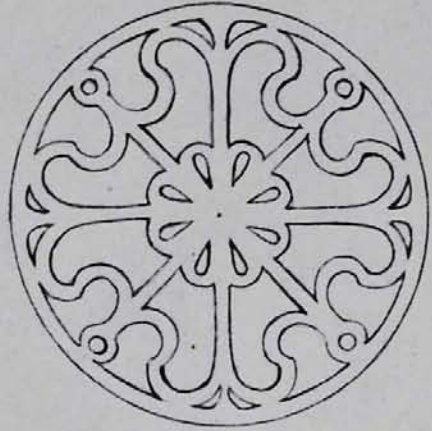
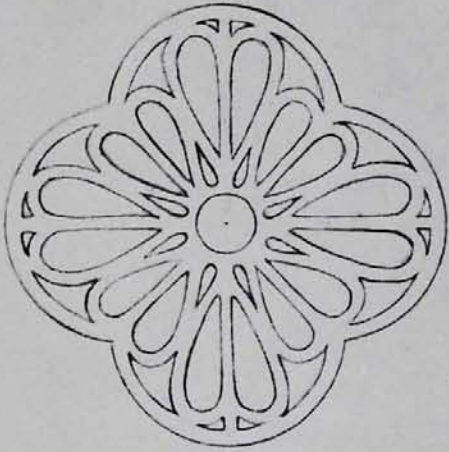
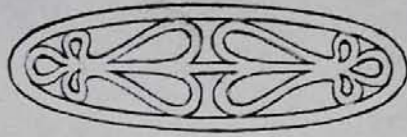
EXERCISE IN VARIATION

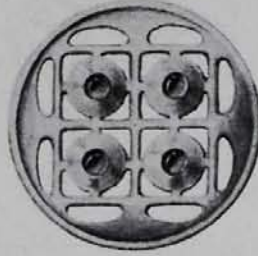
COPY



is put together. It induces the student to look for something beyond the color of stones or the quality of finish on the metal. All parts are given the most careful scrutiny, all elements are composed to harmonize with each other and with the whole. The relation of motives, the direction they pursue and the interest they evoke are critically considered. The shape of the motive and the pattern it generates is of no little importance. The main structural lines upon which the design is planned must be discovered in searching for the secret of its beauty. When the principles that are responsible for the design are discovered and well understood, they must be interpreted in a new light; this is left to the fancy of the designer. Plates in this chapter show several variations of the same theme. This process acquaints the student with the general principles of design and the manner in which others have displayed them. Whatever comparisons are made between the original and the variations they are for the purpose of making certain that the new design has elements common with the old. In adapting the old material in other ways or to new shapes the result may be thoroughly convincing in its resemblance to the copy or it may be an entirely new idea.

In working out such problems as those on Plates LXXVI and LXXVII the copies in metal design should be smaller and smaller till they are the size of the larger pieces of jewelry. Having arrived at this stage we can focus our attention to jewelry and make variations as illustrated on Plate LXXIX. At the beginning it is a good plan to keep the variation as closely related in character to the copy as is possible as Fig. 198, that is, not to make a variation that is too foreign to the motive in the design. Later on, when the student's acquaintance is wider in regard to what the ring or brooch or pendant should be, he can easily apply the motive in the copy to a ring, pendant or brooch as the illustrations on Plate LXXX.

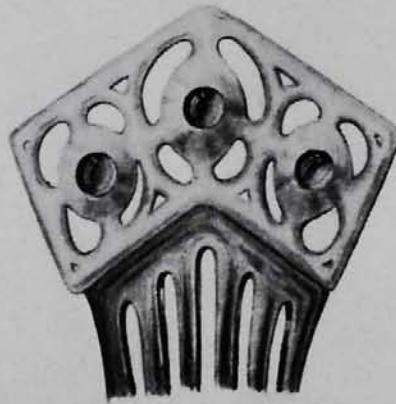
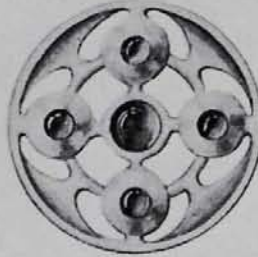


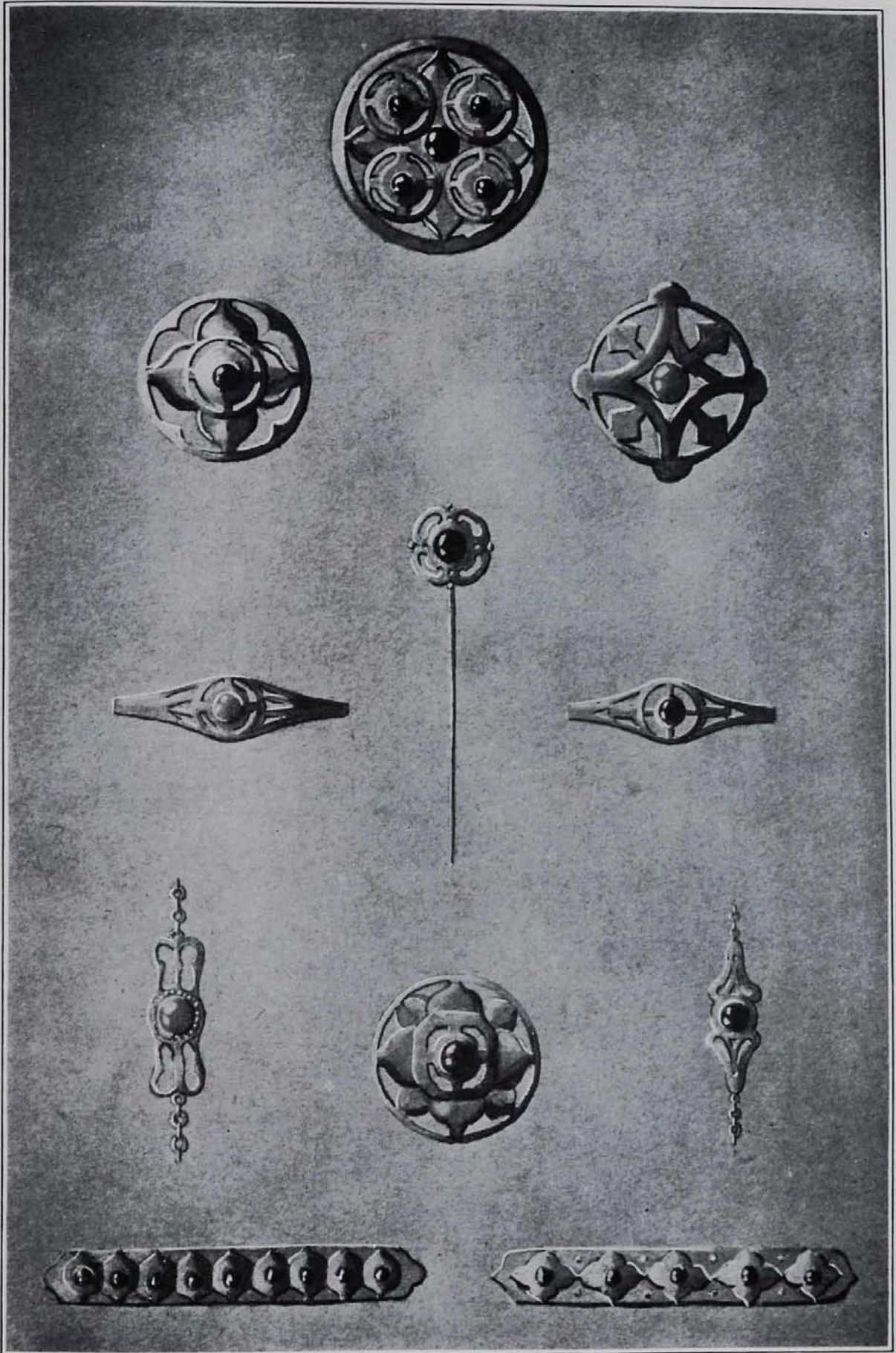


COPY



VARIATIONS





If the student's mind can be so opened and so influenced by the forms in nature or other designs, that whatever he looks at suggests an idea as shape or as arrangement for his peculiar line of work, then and only then can we hope that he will design with ease and enjoyment.

This changing and interpreting a motive in different terms is only a stepping stone to purely original work. And yet, roughly speaking, it can be said that nothing is strictly original, that everything we have has been suggested by something else, or it may be a modification of what went before.

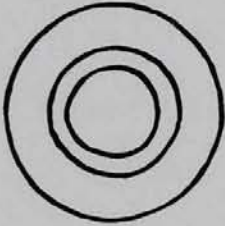


Structural Elements of the Circle

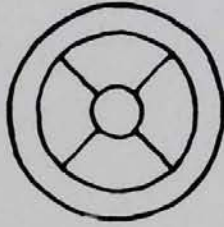
WHILE areas such as circles, rectangles, squares, ellipses, etc., may be modified with lines and masses of an infinite variety the results produced invariably represent, to a more or less degree, either motion or rest. Whatever the character of the design there is certain to appear structural lines which delineate the masses suggesting movement or repose. The pattern may, therefore, be either static or dynamic.

The circle does not evoke any movement if it is small enough to be taken in by the eye at a glance, but if it is so large to cause the eye to follow its circumference then it may set up a feeling of movement. Fig. A, Plate LXXXI, showing the concentric circles, fails to set up any action, excepting possibly that of convergence. Fig. C shows lines radiating from the center of the circle; if a concentric circle is described in it as in Fig. 199R the effect is unchanged. Figs. N, O which consist of a triangle and a square respectively do not impart any feeling of movement whatever; they produce a static effect. Fig. S is divided by a curve which suggests a graceful movement. The eye is lead through the circle from a point on one side of the circumference to a point on the other side in a rhythmic manner. The added lines in Fig. H help to give more movement. Figs. F and G impart an upward motion from a common point. The lines radiate from a center on or near the circumference into the area and eventually back into the circumference with rhythmic motion. Examples of lines radiating from a common point abound in such natural forms as leaves, shells, insects and butterfly

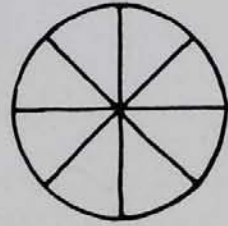
STRUCTURAL ELEMENTS
FOR
CIRCULAR DESIGNS



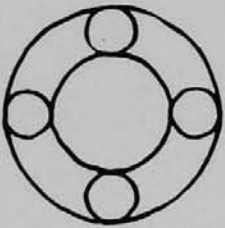
A



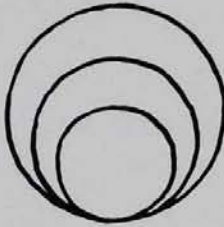
B



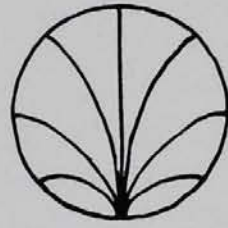
C



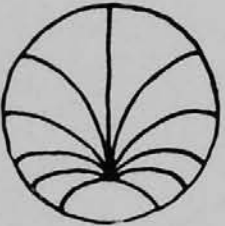
D



E



F



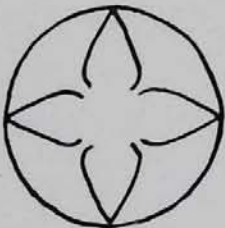
G



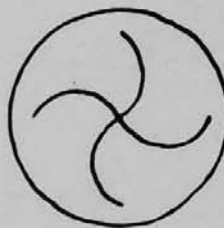
H



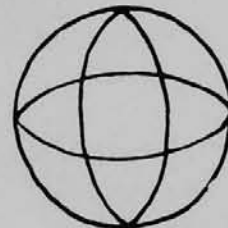
I



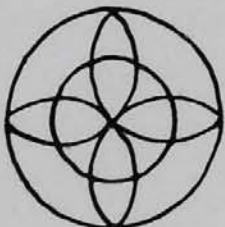
J



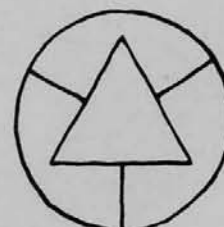
K



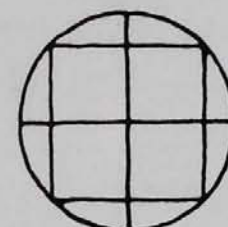
L



M



N



O

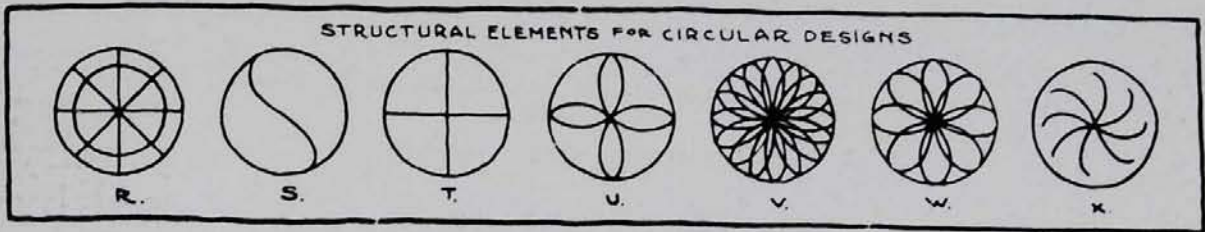


FIGURE 199

wings, and many other nature forms. Fig.H is a variation of the same idea; the lines radiate into the circle from different points on the arc within the circle. Fig. U is a modification of Fig. T. The two diameters have given way to curve lines radiating from the center of the circle as a common point. Still it fails to stimulate any sense of movement. If these curved lines are multiplied as Fig. V and are allowed to intersect, a semicircular movement beginning from the center of the circle to the circumference and back to the center, is slightly apparent. When these curved lines are intersected by another concentric circle as Fig. M the movement becomes less conspicuous on account of the added circle crossing the movement just described. Fig. K suggests a rotary motion. As more lines are added radiating out from the center as Fig. X more motion is created. Figures that are symmetrical on both the vertical and horizontal axis and have a common center with that of the circle represent little if any movement, while elements in the circle which do not repeat the circle and are not symmetrical give the effect of motion.

The drawings in this chapter represent designs in the abstract; the lines enclosed are structural elements upon which patterns of the most intricate nature may be constructed. The designs herewith shown have only the fundamental elements; their variations and modifications however may be carried to infinity. Circular designs may be tested with the structural elements presented here and it will be found that they will have the fundamental lines in common with some one of these abstractions.

In creating designs in the circle the character of the structural elements to be used should be conspicuously kept in mind and the result should be consistent with the elements chosen. In jewelry design, however, such rotary motion as expressed by Fig. X and K, or similar strong effect of movement should be discouraged.

The ellipse and oval are variations of the circle. By virtue of their contours they impart a graceful and varying movement which is slightly apparent; for this reason they are preferred to the circle. Curved lines in such areas that are not concentric or that do not radiate from the center are apt to stimulate a sense of movement that is very pleasing.

Plates LXXXIII to LXXXVI show the square and circle similarly treated.



The Evolution of Design

PLATE LXXXII attempts to make clear the evolution of design. The first thought in Fig. A first step, was the circle and the structural elements. It designated the contour and limited the area of the design. Vertical and horizontal lines were then added. The second step of this same figure has additional diameters. The third step shows a more pleasing result by the modification of the area in the second step made by the straight lines. The succeeding Figures, B, C and D, represent the same method of developing designs by the use of different elements. Instead of the circle being intercepted by straight lines we have curved lines within the circle. It can be seen by the different steps how the designs begin with a mere thought in lines, arranged in a circle. In each step either something more is added or some part is modified to make the design practical. Plates LXXXIII to LXXXV, and LXXXVII also show geometric construction of circular designs. The figures present elements based on geometry upon which designs may be constructed. The circles are capable of unlimited variation. These plates represent a few ideas which might be varied infinitely as e, g. Plate LXXXVII shows the variations of one idea namely, circles within a circle. Plate LXXXVI shows the square with abstract ideas. Whatever the contour used, whether the outlines suggested by these plates or their modifications, all the designs have structural elements. Every design must begin with an idea, either abstract as those represented by these

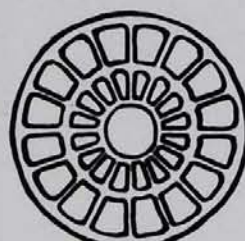
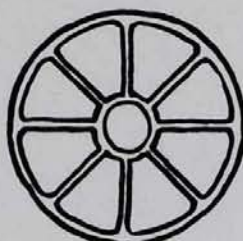
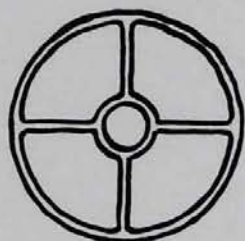
EVOLUTION OF DESIGN

FIRST STEP

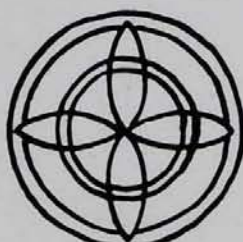
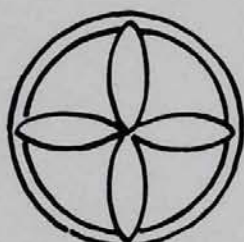
SECOND STEP

THIRD STEP

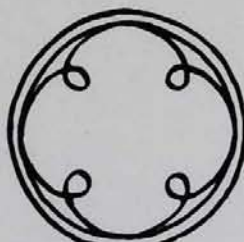
A.



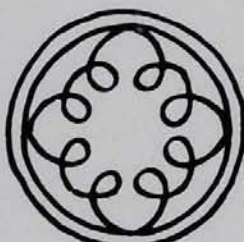
B.



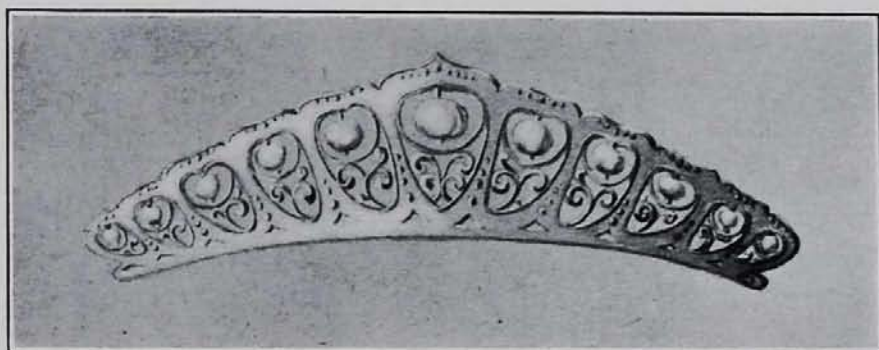
C.



D.



plates, or concrete as natural motives. The success of the design, however, depends on the fine space relation among all its parts. The proper relation that must exist between each part and the whole design cannot be stipulated in words nor reduced to a formula. This can only be acquired by the study of fine examples. The surest way of attaining the desired result is by making many careful copies.



Chapter XXIX

Geometric Designs

IT is quite important that the student have a knowledge of the use of mechanical drawing instruments in so far as they are used in connection with jewelry designing. If possible, designing of this kind should be preceded by a course in elementary mechanical drawing so as to become proficient in the use of the instruments and to obtain a knowledge of a few geometric exercises.

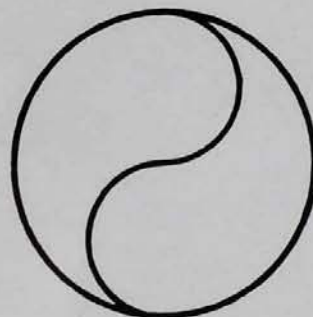
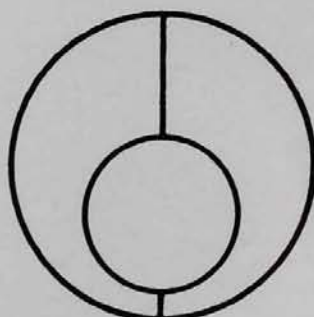
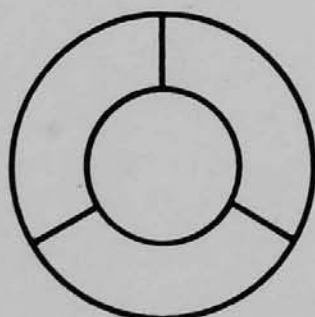
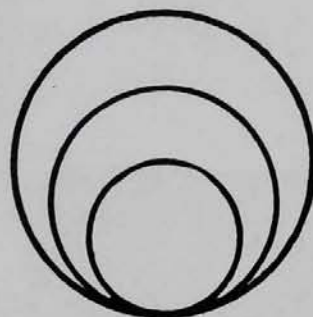
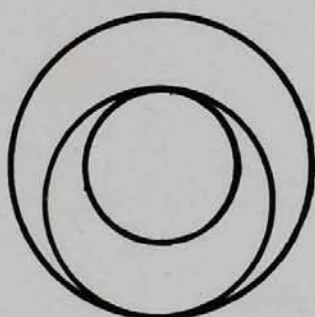
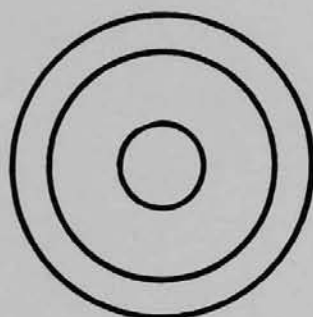
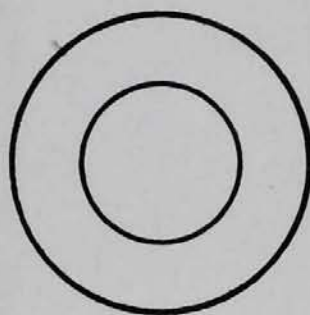
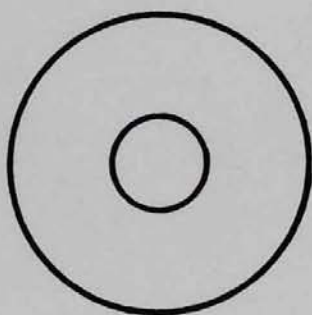
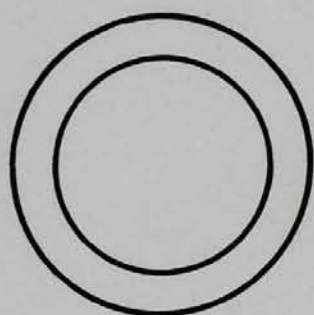
The aim of this problem is to obtain geometric designs without regard to practical ideas. Mechanical drawing instruments, T square and triangles comprise the necessary equipment for this exercise. The designs are begun in a very simple manner, using first circles, circles and straight lines, and then straight lines alone. Begin first by making six $1\frac{1}{2}$ " circles; describe concentric circles of various radii in these circles already made seeking to break up the areas in an interesting way as represented by Plate LXXXIII. On another sheet make more circles. This time use straight lines, striving to obtain a fine relation of areas made by the lines. Plate LXXXIV represents a number of circles broken up in the simplest way possible, while Plates LXXXV and LXXXVII have some designs of a more interesting combination because they represent some common figures with which we are familiar. Now take the square and break it up with straight lines beginning always with the simplest possible way, making them more complex as the work progresses from one square to another. Plate LXXXVI represents a few squares selected out of many that were

made because they possessed interesting space relations. This exercise should be carried out with other shapes such as the oval, ellipse, rectangle, and triangle. Japanese crests may serve as a source of suggestions for these abstract geometric designs.

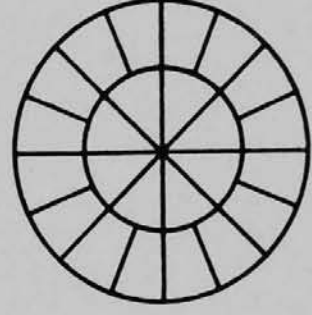
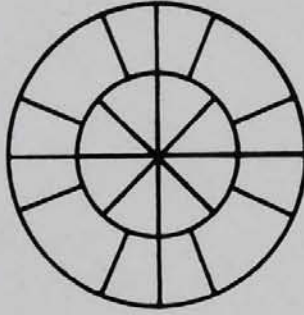
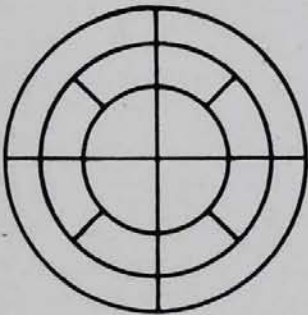
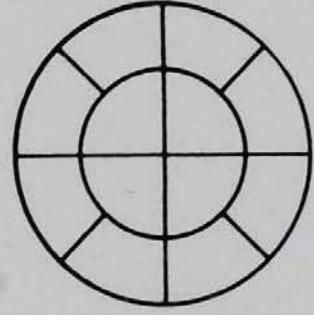
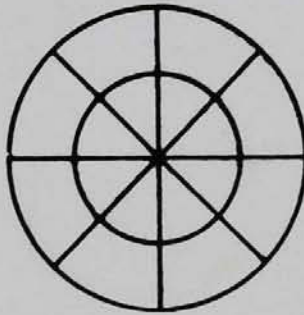
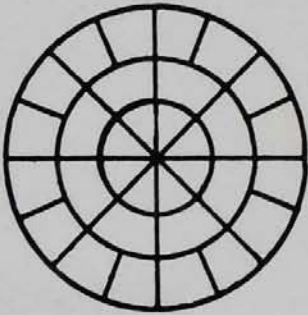
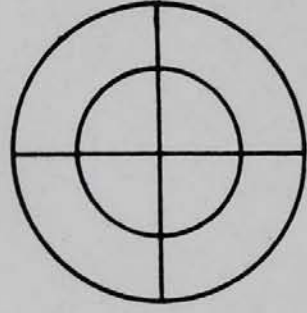
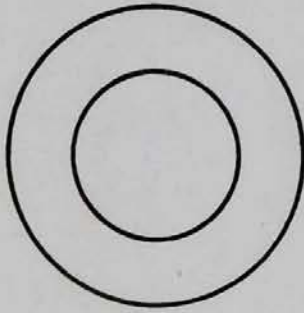
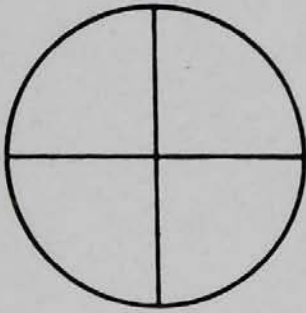
Plate LXXXVIII represents a number of geometric outlines that are commonly used in jewelry design. These outlines may be modified to infinity. A study of jewelry will reveal the fact that they are founded on some one of the outlines herewith represented or modifications of these.



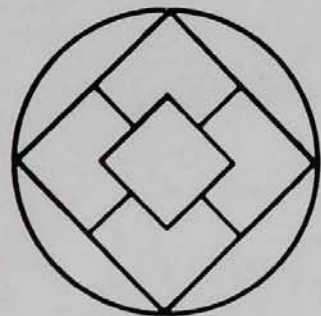
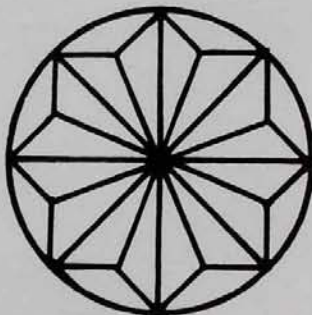
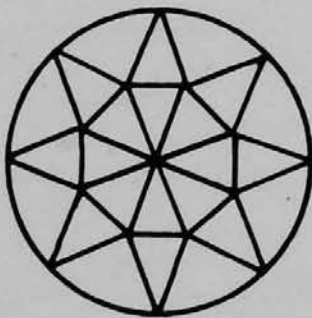
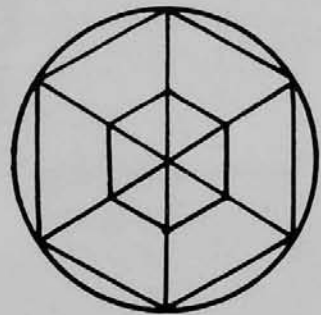
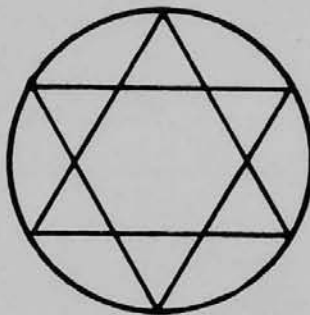
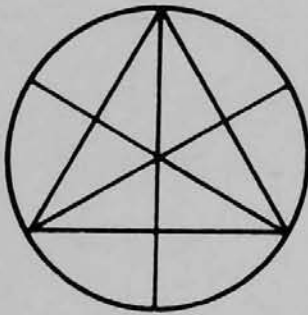
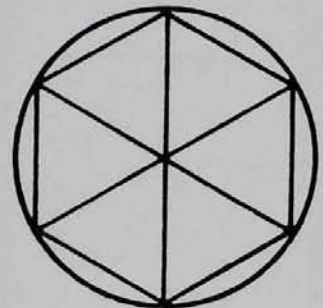
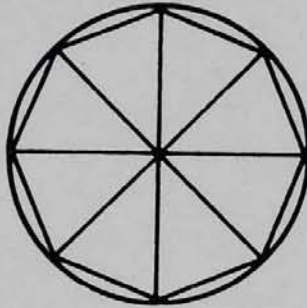
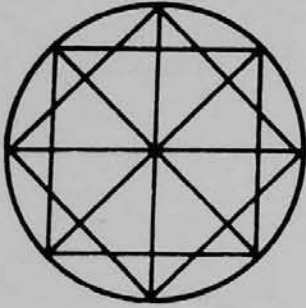
GEOMETRIC CONSTRUCTIONS
CONCENTRIC, EXCENTRIC
AND STRAIGHT LINES



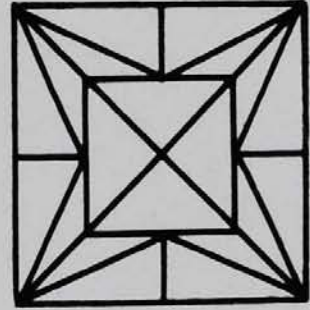
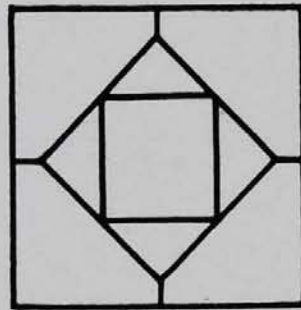
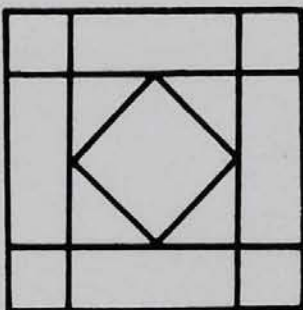
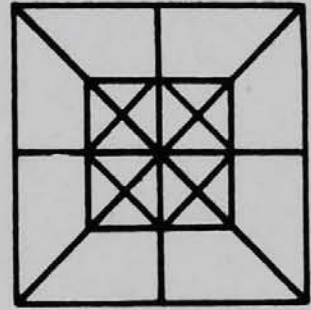
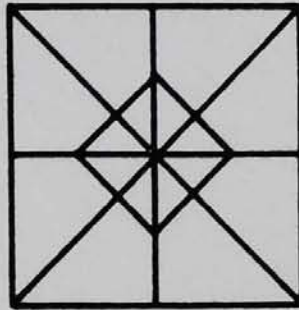
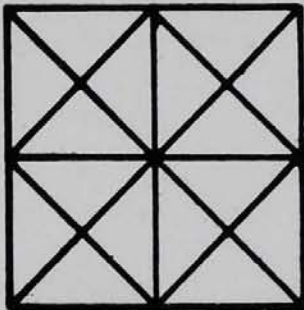
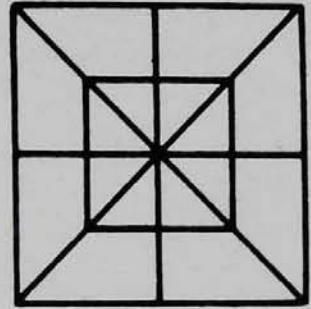
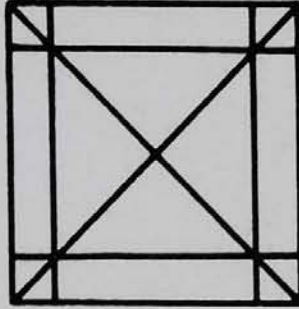
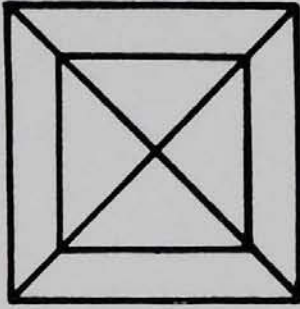
GEOMETRIC CONSTRUCTIONS
CONCENTRIC AND STRAIGHT LINES



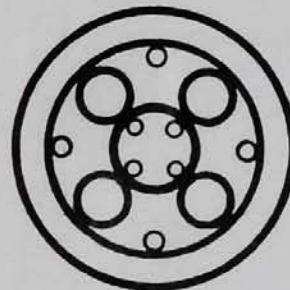
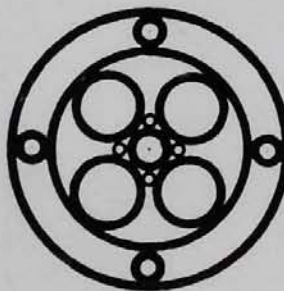
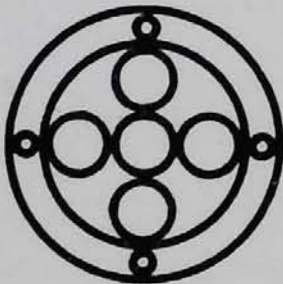
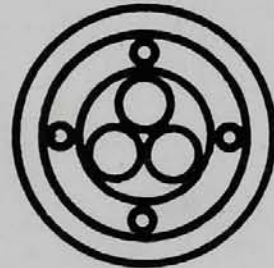
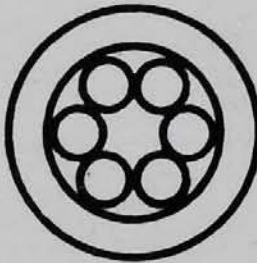
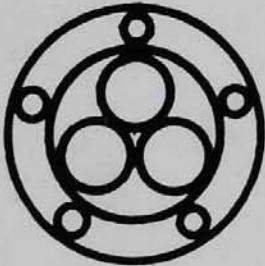
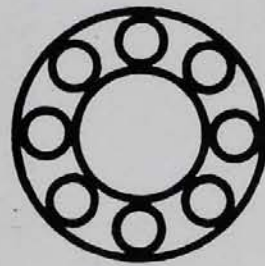
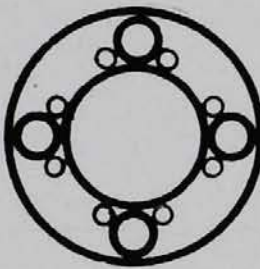
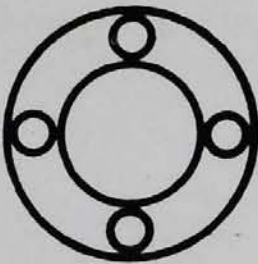
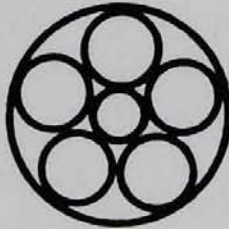
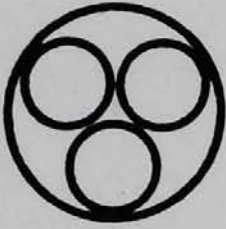
GEOMETRIC CONSTRUCTIONS
STRAIGHT LINES WITHIN THE CIRCLE



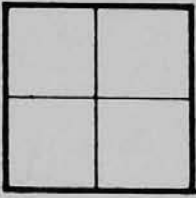
GEOMETRIC CONSTRUCTIONS
STRAIGHT LINES WITHIN THE SQUARE.



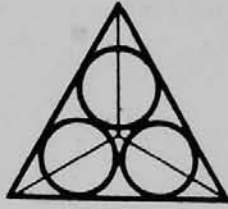
ARRANGEMENTS OF
CIRCLES WITHIN CIRCLES



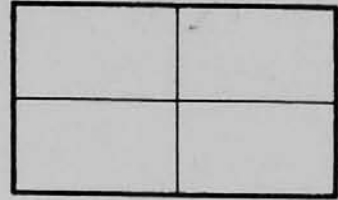
OUTLINES ON WHICH JEWELRY IS BASED



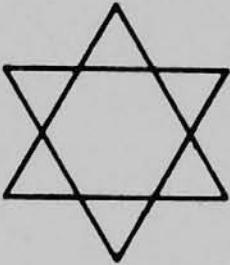
SQUARE



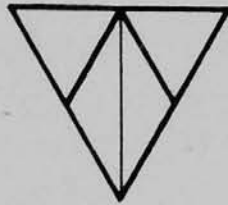
TRIANGLE



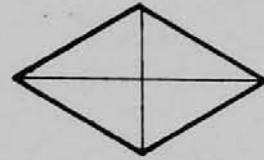
OBLONG



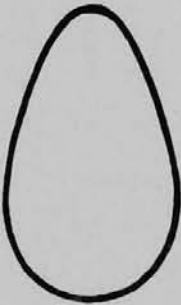
STAR



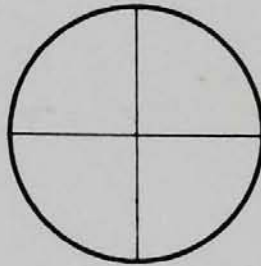
TRIANGLE



DIAMOND



OVAL



CIRCLE



OVAL

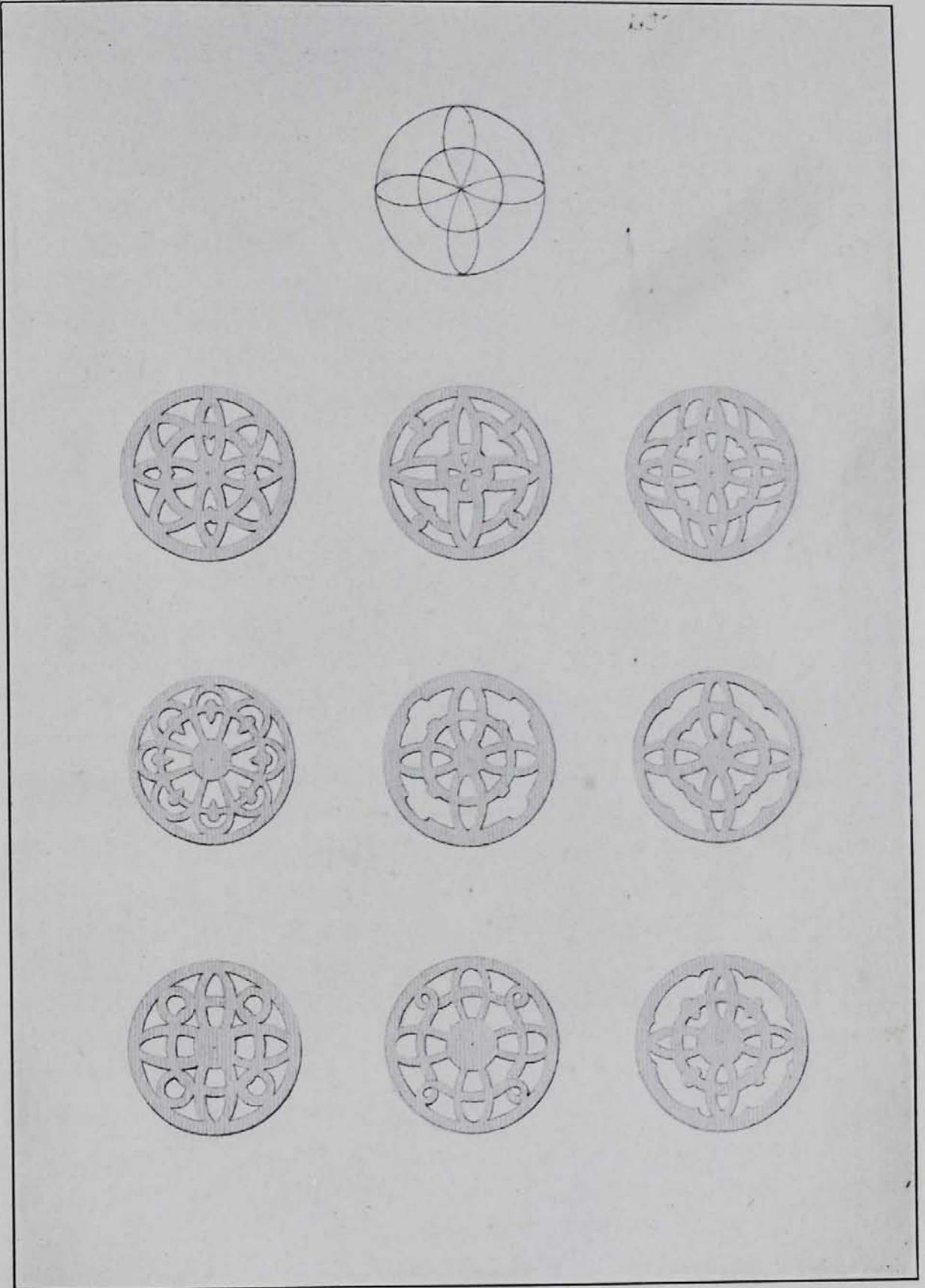


ELIPSE

First Problems in Design

DESIGN always begins with certain conditions and restrictions. It is of primary importance that the requirements of the problem are thoroughly understood and adhered to. It should be known what purpose the object is to serve as this usually confines it to certain limitations and possibilities, and is one of the factors which helps to determine the process of execution. The method of executing the motives is also governed by the material in which it is to be realized. The technical process used to carry out the decoration serves in aiding the structural composition of the design. These are conditions by which the problem is governed and they help toward the solution. The more definite the requirements for the problem, the more it is confined to certain boundaries and ultimately the easier it is to produce a result.

The problem is to design a pierced circular brooch, without a stone, measuring about one inch in diameter. The requirements of the problem call for a contour that is circular. The next point to be determined is the kind of motive or ornament to be used and the way in which it is to be carried out. It has already been stated that it is to be pierced. Motives may be either abstract or characteristic of natural forms. It is intended here to use an abstract motive, and to have the design radially symmetrical. It is to be constructed on the structural lines as represented in Plate LXXXIX, bearing out the abstract figure chosen. The simplest possible design is this figure as selected with plain bands of metal. Modifications of these bands may be made by changing slightly the metal parts either in the perforations or in the metal areas. Variety of spaces, with the proper adjustment of relative proportions, adds interest and



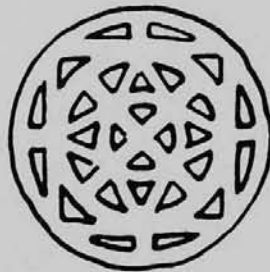
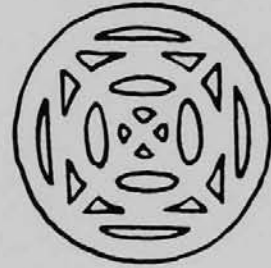
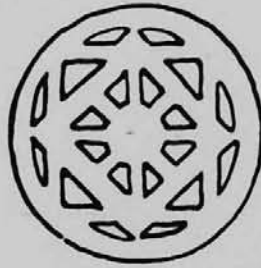
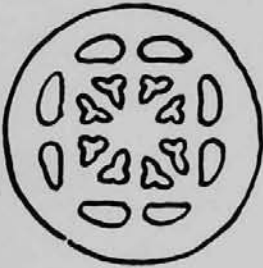
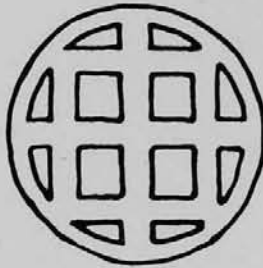
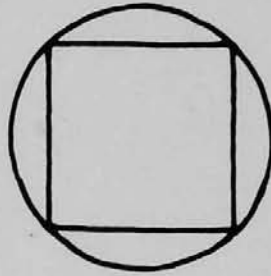
should be accomplished with a surety of purpose that is strongly convincing. Plate LXXXIX represents a circle with the structural lines and nine designs constructed upon these same lines. All of the designs illustrate the idea of curved lines radiating from the center of the circle and intersected by a concentric circle. The designs on Plate XC are based on a square within the circle, while those on Plate XCI are circles within circles and those on Plate XCII are combinations of circle and straight lines. The design displayed under each of the pure designs in lines may be rightly considered as variations of the same theme. In working out these problems circles an inch in diameter should be described with the compasses and then diameters at right angles, or radii may be drawn in some of them as a foundation for the structure. A concentric circle may be inserted in such a way as to divide the radii in a fine ratio.

The designer should keep in mind the fact that the lines represent bands of metal. The process should be made free and easy, proceeding from one circle to the other without stopping to make pronounced changes in any one till all the circles have been sketched in. Upon examining the designs it will be found that some are good while others will have to be discarded. The former may be improved by placing a piece of tracing paper over the design and making the necessary changes; in this way we may be able to evolve order out of chaos and at the same time retain the original intact. When a satisfactory number of designs have been accurately drawn on tracing paper, they may be spaced on the proper size sheet and transferred according to the method described in Chapter XXIII, page 282.

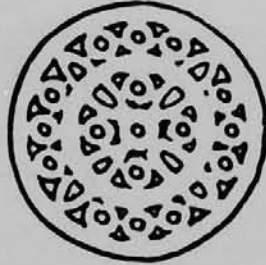
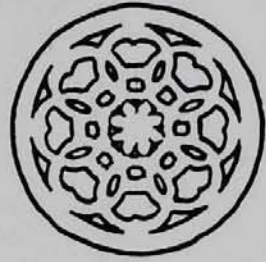
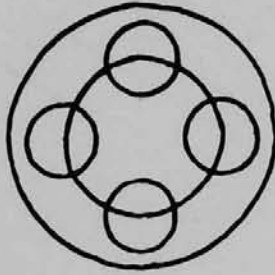
After the designs have been neatly drawn they may be shaded in pencil as described in Chapter XXXI, obtaining a result as shown by Plate LXXXIX.

Whether the brooch is to be circular, elliptical, square, rectangular or any other shape the problem may be solved exactly as this one of the circles.

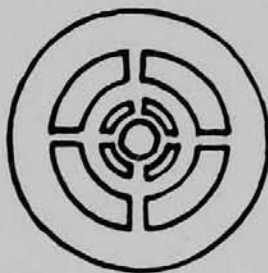
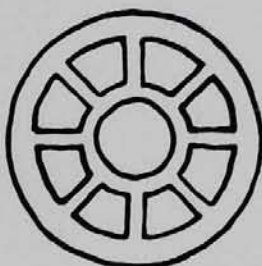
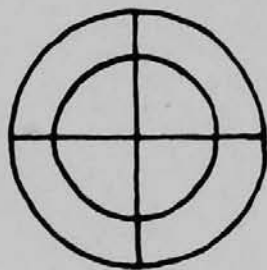
DESIGNS BASED ON SQUARE WITHIN CIRCLE.



DESIGNS BASED ON CIRCLES WITHIN A CIRCLE



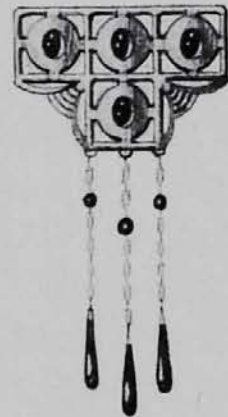
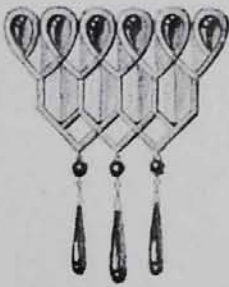
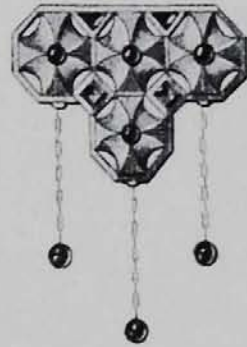
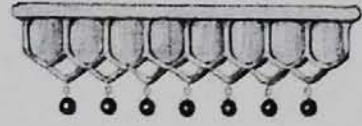
DESIGNS BASED ON CIRCLE
AND STRAIGHT LINE



Rendering in Pencil

TWO VALUES

IT is required to represent a flat metallic surface with thickness. Make a copy of a perforated design or take one of the circular designs on Plate XC. Execute the drawing with a medium grade pencil. The drawing must be accurate and light in its lines. On another sheet of paper practice the exercise of making lines equally distant and of the same grayness, using a medium soft pencil. These lines must be drawn uniform in width, which may be accomplished by turning the pencil slightly with every six or seven strokes thereby preventing a flat place on the lead, also aiding in keeping a point. The lines may be made about 1-64 of an inch apart or even less. A uniform value will be the result when even pressure is brought to bear with every stroke of the pencil. Continue this exercise till it is possible to produce areas of even flat tones of different values. Whenever it is necessary to continue the length of lines or to increase the area of a tone, care must be exercised not to overlap the ends of the lines. If the lines are allowed to overlap a dark streak will appear across the gray tone, which is objectionable to good results. When this exercise is mastered it will be noticed that these lines, en masse, blend as one smooth shade of gray producing the effect of a flat value, which is the desired result. Cover the metal area of the design with these vertical shade lines. When this is done, imagine that the light on the object falls from the upper left hand corner. This will make the edges dark that are not affected by the ray of light. With a medium soft pencil draw the dark edges. This gives the flat surfaces their proper thickness. The width of



these shadow lines is indicative of the thickness of the metal. When approaching the light they should be made to gradually decrease in width. Plate LXXXIX shows designs rendered in this way.

THREE OR FOUR VALUES

From the previous exercise in line rendering we find that the closer the lines are made the more is the effect of a flat smooth tone. By allowing the lines to touch each other in a lateral position, and with much practice the student will eventually be able to produce the desired values.

The exercises on Plate XCIII show the lines drawn closer than in the previous ones and the line effect is less conspicuous, which is highly desirable. The examples here shown are not absolutely flat in character but have some rounding surfaces. The high places affected by the light are left the value of the paper while the surfaces less affected have a flat middle gray tone. To render in four values make a number of copies of good jewelry designs. When a careful outline is obtained represent the thickness of the metal on the shadow side by a heavy dark as was done in Fig. 187A, (the sword-guard). Now introduce a middle gray on the surfaces that do not catch the light as in Plate LXXXIX, keeping the lines close together. Thus far the metallic part of the object is represented in three distinct values: namely, black, middle gray and white. In some instances, however, it is necessary to introduce a value darker than middle gray to produce more modelling effect. This value is half way between middle gray and black.

The cabochon stones and drops are represented with very dark masses of blacks wherever the light affects the stone most. Upon examination of a transparent stone it is noticed that a bright high light surrounded by a dark, appears on the side affected by the light, and, that part of the stone away from the light is light, due to the ray permeating the stone. The shape of

the high light must be carefully recorded with the dark mass around it. The dark must blend gradually into the light area of the stone caused by the reflected light and this same dark must make a sharp distinction with the high light. The different steps involved in rendering a cabochon and a faceted stone are shown on Plate XCIX.

AN INDEFINITE NUMBER OF VALUES

Heretofore the problems have been confined to a definite number of values for the sake of clear understanding and simplicity of representation. The number of values chosen in these exercises were such as could easily be distinguished with the naked eye. As the values in the preceding exercises were increased, the difficulty in detecting them was correspondingly increased; e. g., it may be a simple matter to enumerate the planes when a sphere is rendered in three or four flat values, but as the number of values approaches infinity so the difficulty in counting them increases also. A sphere rendered in many values would result in a fine gradation of values from light to dark or vice versa.

The problem in the next exercise is to render surfaces like that of a sphere; it is a pendant with a large stone, azurite and malachite, surrounded with chased leaves having silver shot soldered between them. Plate XCIV represents the different steps taken in rendering this pendant although it is not to be understood that the six steps taken to arrive at the finished product is a criterion for all problems in pencil or brush rendering. The approach might have been a more gradual or more abrupt one, but for all practical intents and purposes the six steps seem to suffice for this exercise at least.

Fig. A represents the pendant drawn in pencil while Fig. B has a dark added in the background of the leaves, thereby segregating them and the same value for the dark on the stone. From practical experience it has been found that whenever shot are soldered to metal parts, as represented by this design,

the solder fills in the spaces between the points of contact for a little distance, hence the darks between the shot near the ring and the shot and leaves. In this same step draw the shape of the high light on the stone and the shadow on the ring cast by the slide, as well as the dark on the slide itself. The darks should be a little lighter than desired for the reason that there is chance of making them too dark; if they are found to be too light they can very easily be darkened. Fig. C consists merely in delineating the dark area on the leaves and shot while Fig. D has a middle value over the dark side of the leaves just separated. Add a light value to the stone on the light area, and to the dark side of the bezel up to the edge representing the thickness of the bezel. The drawing although done in but three values begins to look somewhat modelled. The fifth step, Fig. E, represents the addition of a darker value than used in Fig. D, one added to the leaves and bezel but not covering so much area. The examination of a brightly polished surface like that of a leaf, with the light coming from the left hand side as in this exercise would show a decided dark just at the spot where the surface turns away from the light. This dark is here represented by a value a little lighter than eventually needed. In this same step the dark of the stone has been darkened somewhat, also the light part. A middle value was added to the loop and the ring, taking care to leave intact the parts affected by the lights. The darks on the shot have been carefully drawn and filled by a slightly graded value. As this value approaches the light it is made a little darker and is made lighter where the metal surfaces turn away from the light. That is because this surface in question receives reflected light from other bright surfaces next to it. Notice that these reflected lights occur on all of the leaves. A little more dark has been added to the bezel next to the stone giving it a convex effect.



A



B



C



D



E



F

In general Fig. E looks flat and lifeless, we see at once that it needs some heavy darks to bring it to a finish. Up to this time all of the shading is executed with a 2H Koh-i-noor or some similar grade. The darks on the stone, as in Fig. F, are now darkened with an HB pencil, keeping darkest those on the right side which receive less light. Now darken the light on the same side and let it blend gradually into the light as it approaches the top of the stone. The left side of the stone should be darkened somewhat because this area receives less light than the area around the high light. If the pattern made by the dark and light of the stone looks blurred and the edges indistinct separate them with a dark by using always a very sharp HB pencil. The bezel on the left side next to the stone casts a little shadow, and this made dark will offset the two quite distinctly. Then, too, on the right side the edge of the bezel next to the stone receives the light, hence it is left intact, but appears lighter here because of the dark on the right and left of it. This kind of stone oftentimes has the azurite streaks running through the malachite which is represented by the dark and light effect, hence the fine dark lines, making an interesting pattern. The stone now appears round and real because of the rich dark areas.

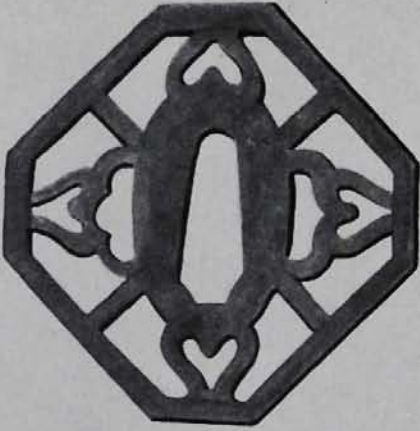
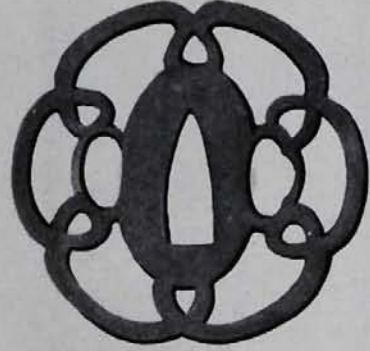
With the HB pencil, always very sharp, cover the same background area as was done in step 2. This is done to define the leaves more clearly since the edges next to the darks may have been blurred in working over them. In Fig. E one dark was added upon another dark, though covering less area; now over these two darks add a third, covering still less area, and when this has been done on all the leaves and the shot, as in Fig. F, they should appear to be highly polished. Add some dark accents to the slide and ring. The shadow on the ring cast by the slide should be slightly darker next to the light on the ring. This gradation is due to the fact that the shadow next to the loop receives light from it, hence it lightens the shadows next to it.

Rendering with Brush

IN BLACK AND WHITE

WHEN a discriminating sense for close differences of values has been developed and the fine muscles of the fingers have been so trained that a delicacy of touch results from every pencil mark, the student is prepared to undertake brush rendering.

Make several full size drawings of sword-guards on a sheet of white water-color paper. The models chosen should be simple in their outline and pattern as those on Plate XCV. When the drawings are complete rub them lightly with art gum to reduce the pencil marks to a grayness. Unless this is done, especially when light colored washes are used, the pencil lines will show through the color. With a number 3 brush mix some charcoal gray and water in a tray, to obtain a value half-way between white and black. More than enough color to cover the designs should be mixed. The student should always be generous when mixing paint since it is very difficult to obtain the same value if the wash should run short when applying it to the drawings. With the same brush fairly full of the wash, apply beginning at the top of the design and working from left to right till covered, leaving the perforations the color of the paper. If a puddle of paint forms at the bottom of the design, first dry the brush on a blotter and then take up the superfluous wash with the dry brush. This should be repeated till the painted surface appears as one flat tone. Best results are obtained if the board is held in a sloping position as this allows



the paint to flow down gradually and evenly. When the drawings are covered and the paint is dry, mix charcoal gray with a little water to represent the thickness of the metal. Enough water should be used to reduce the paint to a consistency that can be applied; this value should be almost black. Imagine, then, that the light falls from the upper left hand corner; wherever the ray of light strikes the edges it will be light and wherever it does not it will be dark. Apply this dark paint already mixed for the thickness as illustrated on Plate XCV.

When applying paint in superposition or juxtaposition the student should make certain that the first color is dry unless a moist background is purposely desired.

This exercise should be repeated till a satisfactory degree of perfection has been attained. The washes should be smooth and flat,—free from cloudy effects and hard edges.

The exercise just completed consists of but two values, viz., black and middle gray, as it is impossible to show the high light because of the white paper used. The effect produced is a flat surface with a dark representing the thickness of the metal.

The next exercise is done on granite rendering paper. The design, which may be original or a copy, should be smaller in area and more intricate in its pattern than the sword-guard designs, thereby complicating the exercise. The design is to appear as a domed surface. Plate XCVI represents the steps taken when rendering in five values. Fig. A shows the design in pencil outline; Fig. B the result after applying a gray wash; Fig. C same as Fig. B with the addition of a darker wash on the right half of the design; Fig. D a lighter wash than Fig. C with a little Chinese white added. This value covers less area than half of the design. In Fig. E the thickness of the metal is represented by the black edges and the high lights by the white edges.

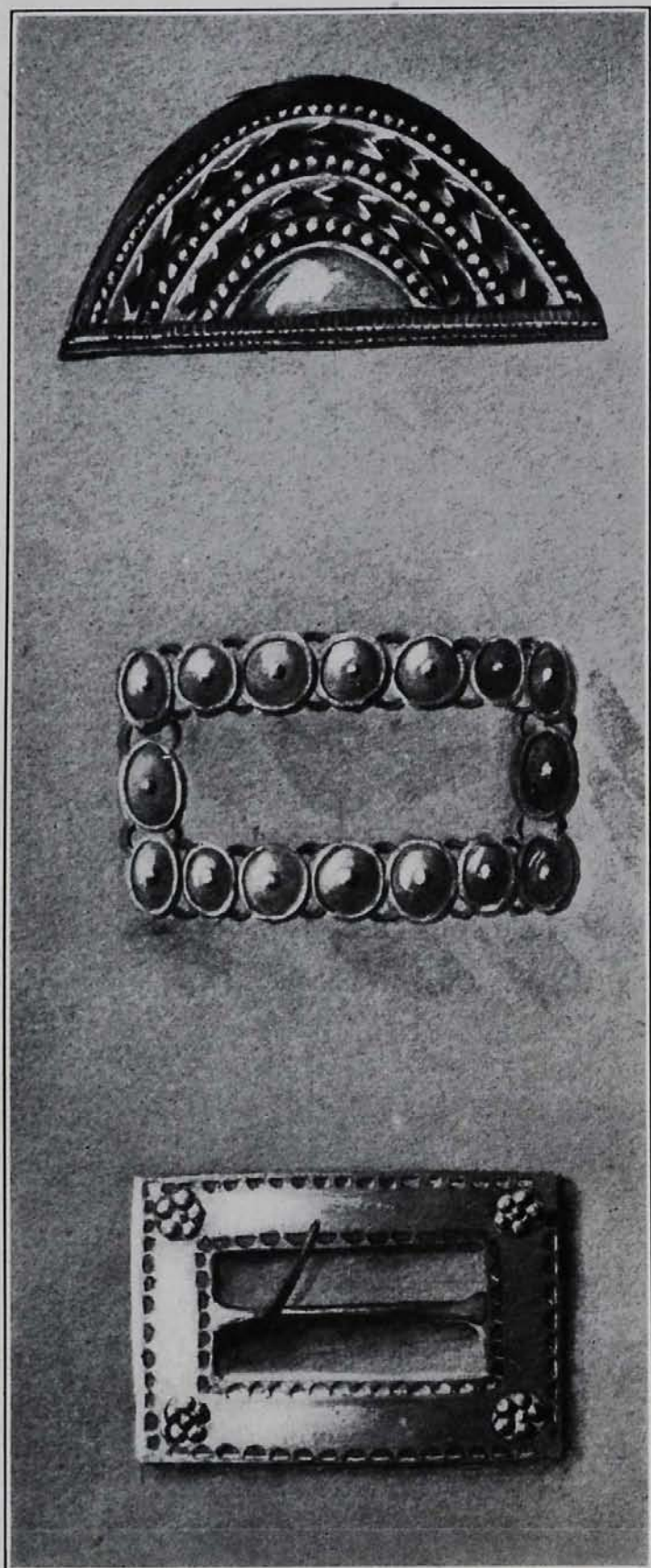
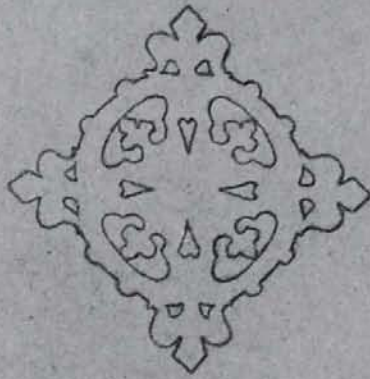


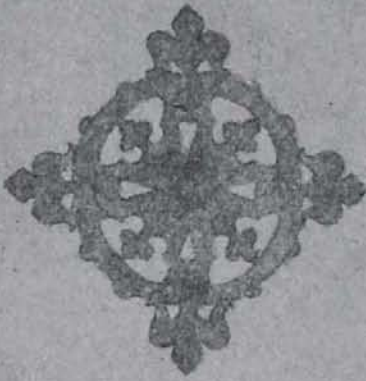
FIGURE 200

brush and a little clear water. To grade one value into another blend the two gradually by stippling with the brush while the surface is still wet.

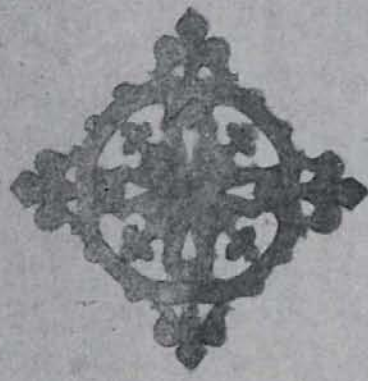
When applying high lights, experience shows that it is better to use the white directly from the tube and apply it with a No. 2 brush slightly moistened. If too much water is used it will be noticed that the white fades into a grayish white as the moisture in the paint evaporates. This means the repeated application of more paint if white high lights are desired. Attention is also directed to the fact that when one wash is placed upon another, covering only part of the area, if the first is dry the second wash will leave a hard edge wherever it does not cover the first. This can be avoided if the second is applied while the ground is still moist or, if already dry, by moistening same with



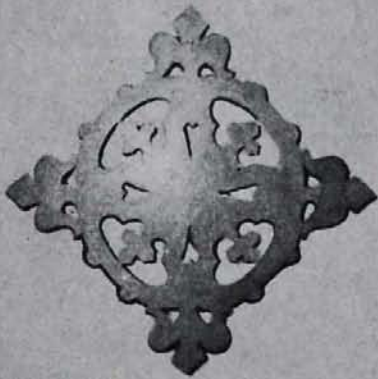
a



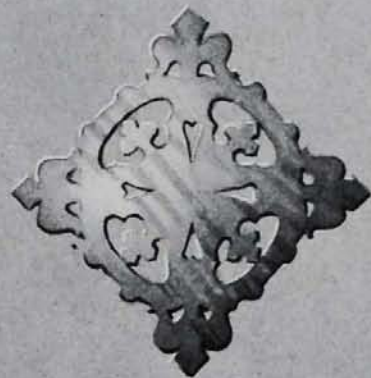
b



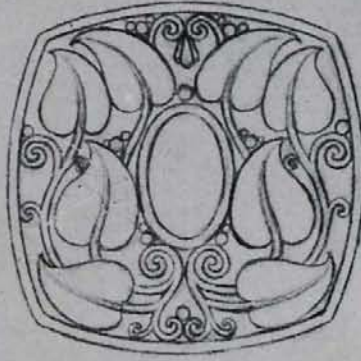
c



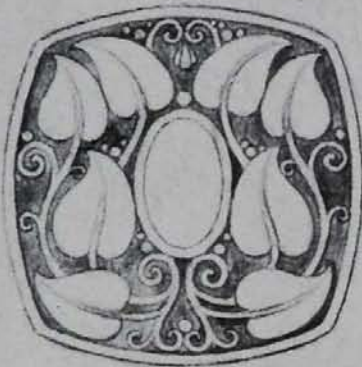
d



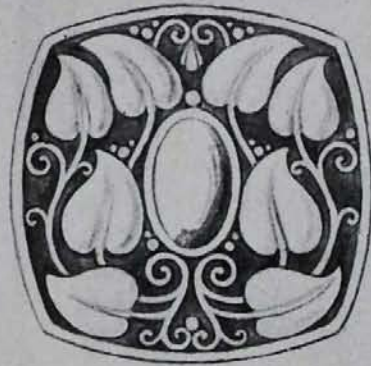
e



a



b



c



d



e

The exercise on Plate XCVII differs from the previous ones in that the design is not perforated and has a stone and silver shot. The method of procedure is the same as before, kept in four simple values. Fig. A shows the pencil outline drawing; Fig. B one flat wash for the background and one flat wash for the stone, a No. 2 brush being used. Fig. C is white mixed with a little water applied with the same brush and a dark added to the stone. Fig. D has darks to represent the shadows cast by the motifs in relief. Fig. E same as Fig. C with high lights added on top of the lights added in Fig. C and the high lights on the stone.

It will be seen in Fig. E that the darks for shadows have been accentuated slightly more than those in Fig. D. This is due to the fact that the exact value cannot always be ascertained the first time. The study of lights on metals will also reveal the fact that they appear as a sheen when the surface is flat, as represented on the outside rim of Fig. E. Throughout rendering the student should make a careful study of lights and darks and the shapes of shadows, for the shadows give life and reality to the shapes of the lights. Without the shadows on the upper left side of the stone cast by the bezel and the shadow on the light side on the lower right of the bezel, the stone would appear very flat and lifeless.

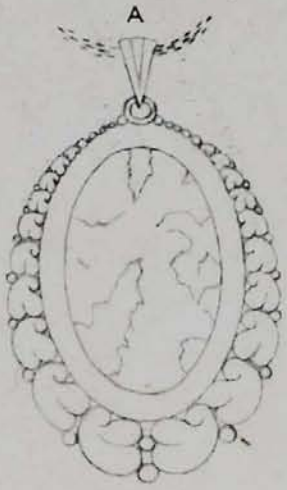
Fig. 200 represents designs rendered from photographs according to the methods just described.



Rendering in Color

IN method, this exercise is the same as the preceding except that the problem is much more intricate as it has more than four simple values. Instead of using black, white, and various tones of grays, we use yellows, red-oranges and browns representing gold colors. The colors here used are pale cadmium or gamboge, Van Dyke brown, vermillion, Chinese white and black. Since there are many shades of gold, no attempt is made to give a recipe for any one special shade. Cobalt blue and various shades of green graded with its complement or black was used for the stone.

Fig. A, Plate XCVIII, shows the pencil drawing slightly rubbed with art gum to gray the blackness of the pencil marks; Fig. B shows the metal part of the design covered by a flat gamboge yellow wash, using a No. 2 brush. The stone is washed in with pale blues and greens. Fig. C shows the addition of one dark on the shadow side of the motives in relief, and shadows cast by the bezel on the stone. For this part of the work a No. 1 brush may be easier to handle although this depends largely on individual ability. Fig. D shows that some darker values have been added in places. The dark is the same as that in Fig. C with a little more Van Dyke brown. It should be noticed, however, that as the darks are darkened they lose life and metallic quality unless Alizarian crimson is added. Fig. D shows the stone worked up more by darkening the blues and greens and the form of the stone modelled. Fig. E shows the lights applied, viz., pale cadmium mixed



RENDERING IN COLOR

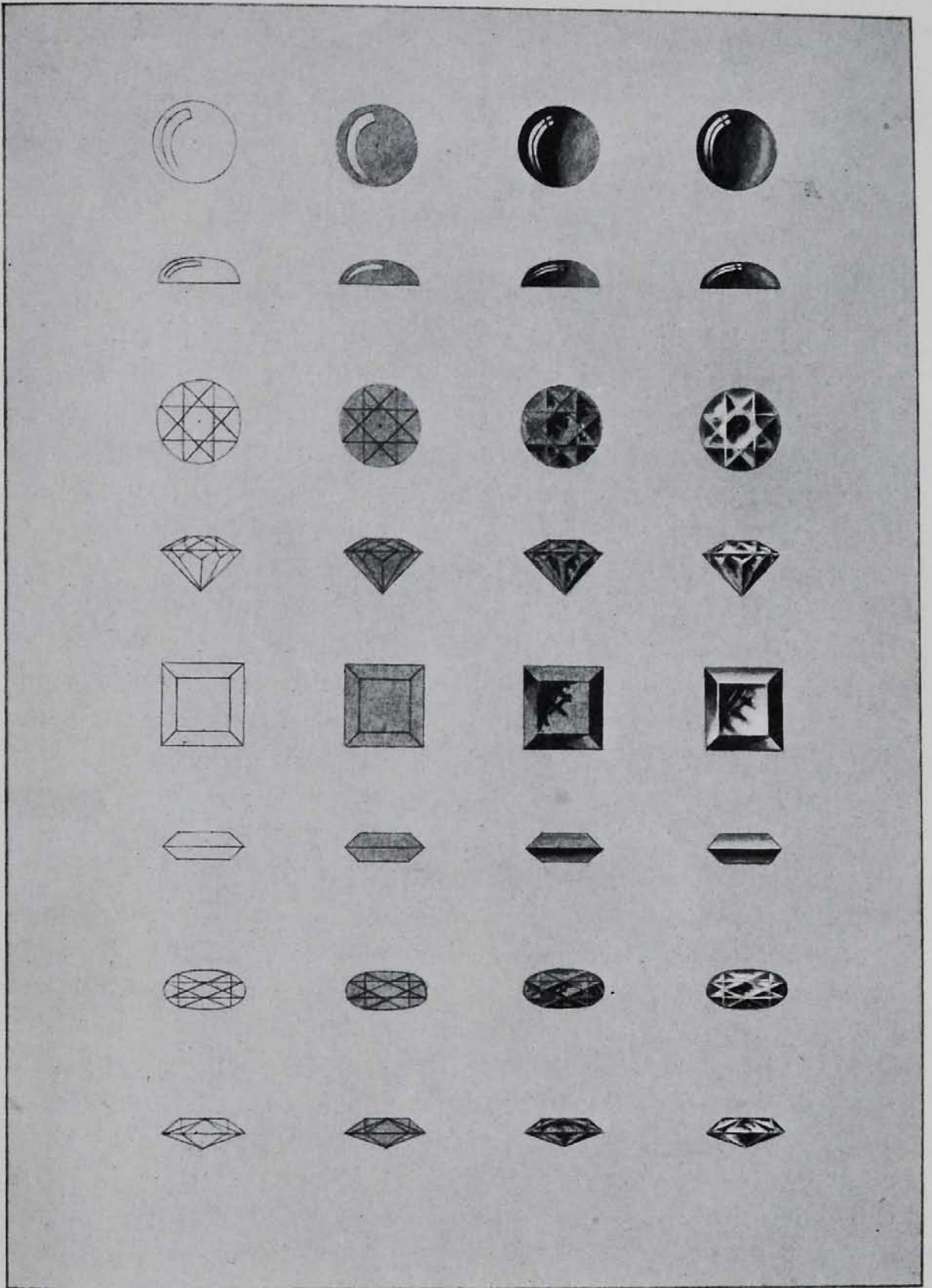
with white for that part of the metal that catches the most light. The darks have been accentuated in places and the colors of the stone darkened on the dark side. Fig. F shows the added finishing touches. A careful study of a highly polished piece of jewelry with relief work will have some reflected lights due to the adjoining surfaces. These lights are represented in the drawing with pale cadmium and a touch of red orange. The last is added to give the color more warmth since these reflected lights are not exposed to much light. The last designs illustrated seem full of light and life. The metal appears to have a bright polish and the high places sparkle with much brilliancy. This is obtained by adding a little more white to the yellow used for the lights in Fig. E. These light yellows when applied should cover less area than those in Fig. E. When all the lights have been gone over by this last yellow, viz., pale cadmium and white the high lights are then ready to be applied. These high lights, which are used sparingly are made by applying pure white paint from the tube with the No. 1 brush slightly moistened. The high light on the stone is pure white paint.



Chapter XXXIV
Rendering Stones

IN jewelry design it is quite necessary that stones be given a naturalistic appearance. To obtain the brilliancy and sparkle with which nature has endowed gem stones is beyond the possibility of pigments. The most that can be accomplished is a faint impression of the natural qualities. As a matter of fact the representation of some gems, such as the very small brilliants, is highly conventional. The effect of light on stones, especially the transparent cabochon cut, must be carefully studied. The dark colored ones seem to emit the light so that they appear light on the dark side and dark on the light side with the high light where the rays have full benefit. The opaque cabochon presents a simple problem of a dark on the shadow side with a light on the opposite side and the high light at the place where the light has fullest play. The shape of the high light on a cabochon stone is of course curved, the shape of the surface. One end of the high light may assume the image of the window as a reflection; and the other end may vanish gradually into the dark as it turns away from the light. The stones should be studied and copied carefully till a thorough understanding of their appearance under different lights is certain.

When the student is thoroughly acquainted with different stones, the method of representing them on paper with their respective lights and shadows becomes highly conventional. To this end Plate XCIX serves the purpose of making clear one possible way of rendering faceted and cabochon stones. These are rendered

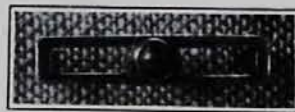


upon a gray sheet, chosen in preference to the white for this illustration on account of its advantage in showing high lights. The first lateral row on the left shows the pencil drawing of the stones with facets and high light carefully drawn. Each stone is represented by a top and front view. The light is assumed to be falling from the upper left hand side. The high lights are usually made a little larger in order to be sure not to have them undersize when the rendering is completed. The second row shows the addition of a middle gray, while the third has a dark with lights added. The fourth row is the finished result with the sparkling high lights. The sparkling lights are often applied with paint taken directly from the tube upon a slightly moistened brush. The white paint on gray paper often seems to dry out darker than expected after the first application. This makes it necessary to apply the paint several times on the same spot. When using white paper the high lights may be left the color of the paper, when this is possible. Oftentimes a wash is put over the entire surface of the stone. In this case the stone is modelled as usual and a high light of pure white paint is used.

A quicker method of rendering cabochon stones, especially the opaque kind, is to first lay on a flat wash of color, then with a little graphite on the point of a shading stub darken the shadow side, making it grade into the light area gradually. While this subdues the intensity of color somewhat, the effect is nevertheless satisfactory. The high light is then applied in the usual way. A careful study of the dark area of a stone, front and top views respectively, will determine the shape of the dark and the customary place for the high light. When the stone is represented in a box setting, it will have the advantage of the metal around it, with its light and dark effect, to offset the gem. The little shadow cast by the thickness of the metal on the light side of the stone and the light of the bezel on the

dark side also help to separate it from the surrounding ornament.

As it is impossible to represent all the facets on very small diamonds, it is necessary to reduce the number of the facets to as few as will adequately explain the gem. Stones not larger than one-eighth inch fall in this class. A circle is first drawn with a fairly hard pencil, then two equilateral triangles are inscribed, one with its apex in line with an imaginary vertical diameter, and the other with a vertex diametrically opposite the apex of the first triangle, making a six-pointed star. A light blue wash is then placed on the entire stone, and when dry, a darker blue is placed on the central area, the table, the hexagon enclosed by the lines of the triangle. The lines on the light side are then represented by white lines, while those on the dark side are kept in their relative values. A high light drawn parallel to the direction of the falling ray is also placed on the table and on the portion away from the light. A little dark of the same value as was placed on the table is added in the angles made by the lines of the triangle. The dark is added only in a few places especially on the light half of the stone and in those angles away from the direction of the falling ray. A touch of pure white is applied on the intersection of the lines forming the triangles. This should be repeated till the lights appear to sparkle.



Chapter XXXV

The Vital Curves

CURVED lines may be graceful, weak, or forceful, and varying or monotonous. Curves abound in nature from the humble plant to her most charming creations. We must select the lines which are most pleasing and fascinating to the eye.

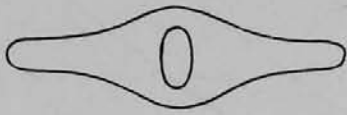
Human nature delights in variety and is intensely interested in change, especially when it occurs at varying intervals. Variety of action, work, and scenery is what gives buoyancy, and spice to life. Human nature craves for change; but if it occurs too frequently, we have a condition of unrest which is even more undesirable than monotony. The question arises as to how much change we can stand without reaching the point of abusing variety to such an extent that we cease to appreciate its value. This depends upon the physical and psychological condition and upon individual differences. While the interest in a mere line does not depend on all three of the above conditions it does rely on the aesthetic turn of mind and on temperament.

A line reaches its supreme beauty when it changes gradually with a slight increasing or decreasing variety for a certain length of its course and then makes a sudden and quick turn to the end. Such a curve is free, stimulating and graceful; it leads the eye slowly but surely for a considerable distance along a flat curve when it hastens the eye to the end with increasing and varying momentum. The changes in such a line occur in a geometrical progression.

THIS IS THE CURVE OF FORCE

The curve of force, Fig. B, Plate C, occurs profusely in nature as a supporting element. Its seemingly straight part implies strength, it gives the feeling of being able to give great support. It is found in many plants, ranging from the blade of grass to the contour of the tall elms. It is the beautiful curve that the sky rocket describes as it leaves the ground in an almost vertical direction, increasing its curve as it loses momentum, until from lack of force it quickly takes a downward direction producing the same curve once again. The eye delights to follow it as it ascends high into the sky, not only because of the path it describes, but also because of the varying speed it generates. This curve is also to be found in the oval and the ellipse but is absent in the circle. It will readily be seen that the circle lacks variety because by reason of its sameness of curvature, any part of its circumference can be superimposed on any other part, hence its monotony and harmony of curvature. It continually changes direction; at every point on the circumference the change is unvarying since it eventually returns into itself. The curve of the circle is not a free curve as it is controlled by a center. It is seldom found in nature except in the cross sections of stems, stalks, and tree trunks. Ruskin calls it the finite curve, while the free curve of the oval and the ellipse he designates as the infinite and immortal curve.

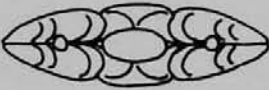
We find the curve of force used by the people of past generations; the Egyptians recognized it in the lotus bud, and papyrus, and they found a direct application in their capitols; the Greeks showed their fondness for it as is evidenced by the contour of their vases, the antifix, akroter and in many other sculptural ornamentation. It did not escape the keen eye of the Romans, as we find it used profusely on their painted vases, their capitals, arches, and even their small common bronze utensils. The curve of force is capable



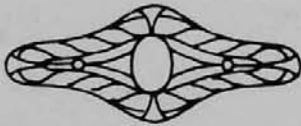
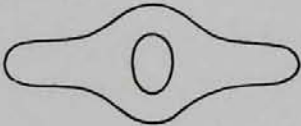
A. CURVE OF GRACE



B. CURVE OF FORCE



C. CURVE OF BEAUTY



of so much variation and acquires possibilities that it would not otherwise possess. The ingenious designer can easily imagine the reverse curve of this line and make it readily applicable to many forms and contours. Such a line makes an "S" curve and by changing its proportions, as is shown by Fig. C, Plate C, it may assume such a perfection as to make what Hogarth regards as

THE CURVE OF BEAUTY

We have observed this line in the rolling hills of the country as they merge one into the other; we recall it in the upward sweep of active flames and in the rolling waves of the high seas. We find it in the back of the female figure when in profile. The artist in recognizing this line of beautiful movement and fine proportion has not failed to use it in his own expression of thoughts and emotions. Master Painters like Giotto, Michael Angelo, and Titian, not only made frequent use of it as the main structural lines of their theme but the composition of a single figure or drapery was made to echo the movement. Corot made frequent use of it in a horizontal position. His points of attraction and general massing of darks cause the eye to move unconsciously in the path of such a curve. The grandeur of his whole composition is largely due to his success in making the elements conform to this exquisite line of beauty. The sensation and joy stimulated by the subtle movement of such curves can be likened to the sounds of a great symphony.

It is the province of jewelry design to use anything that is grand and ennobling. Employing the most precious metals, bits of exquisite colored enamels, gems and pearls of the rarest specimen, it only seems compatible with the above to make use of the line of beauty as a means of unifying metal and stones. Thus the artisan may express his inner feelings and emotions in the mediums just mentioned as the artist does with paints, brushes and canvas. The jewelry craftsman,

however, cannot use curves of an intricate kind if he would observe the use to which his product is to be put. It limits him to simple and restraint lines with a variety of the most subtle kind. Hence his sensitiveness to so fine a curve as herewith considered.

Another vital curve of extreme beauty, found in many forms of nature, is the spiral or Ionic Volute curve, often called the

THE CURVE OF GRACE

The curve of grace Fig. A, Plate C, may be made mechanically, by striking a series of arcs with different centers, but it can best be produced free-hand with the sense of feeling as the only guide. Fig. A which typifies this curve was described as just explained. Nature has imprinted this curve on many forms; the nautilus shell is a striking example of wonderful grace. A careful study of the shell shows how this curve quickens its movement with increasing momentum as it winds toward the center. Here again we have exemplified the arithmetical progression of varying intervals of motion that please the aesthetic sense. Its graceful movement has been recognized as one possessing a supreme quality of beauty, hence its use in various applications. The Egyptians used it on their painted borders, the Greeks made extensive use of it in their decorations as a running border; the Romans employed it in their Ionic capitals and it was appreciated to such an extent as to find a happy combination with the Corinthian capital of the composite style. The Gothic craftsman of the 16th and 17th century found its ready application in iron and the precious metals. The iron grills, the large church door hinges, consoles in architecture and the metal attachments on wooden chests are but a few examples where the spiral found expression. In all the fine examples that have survived we find the spiral was executed with the utmost skill and perfection. The delicate acceleration

of motion in each spiral is brought to the highest perfection in feeling and execution. Figure 201 is as fine an example of a double branched volute curve in its application as can possibly be found. The curve of this iron work should be studied and copied many times, nay, worked out in the metal before it can be appreciated. The goldsmith and jeweler of the guild made use of it in more ways than one. We find the scroll of many more turns in delicate filigree work. This is made possible by the softness of the gold or silver wire used. Oftentimes these spirals, making a double branched volute, are used in a series to make current scrolls.

The designs on Plate C show the application of these fine curves in brooches and lavallieres. They have been made to assume apparently different curves by combining them in unique ways. In some cases the same is repeated in varying sizes, in others the same curve is placed end for end, while in still others they have been so combined as to create the movement of running scrolls.

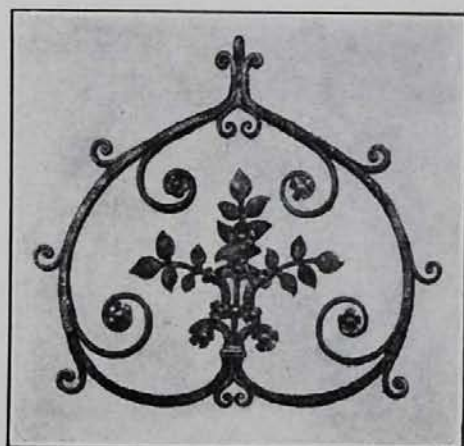


FIGURE 201

Chapter XXXVI

How to Choose Material for Jewelry Design

IN the foregoing chapters mention was made of such natural forms as the shell, beetle, butterfly, flower, feather, etc., as material which is full of decorative motifs, and particularly because they lend themselves to jewelry design very easily.

The sources of design from which may be obtained suggestions for new ideas are countless to the student whose mind has been so cultivated as to see ideas in whole or in the parts of things. It is needless to say that all things in nature are not suitable for this particular branch of design, hence the student must use discretion in his choice of material. From the material which we have selected we can easily see by a rough analysis that they have certain principles of order in common. We find in most of these a certain repetition of shape, a rhythm of line and shape, symmetry on a vertical or horizontal axis, and the principle of order of some kind.

Yet we may look around us and find much in the world of animal or plant which contains these principles and yet is not quite suitable for our particular line of design, simply because it does not lend itself easily to the character of the jewel. The material chosen should be made up of small units which, if repeated in groups, will form a beautiful pattern, and if taken separately will give fine shapes. This can easily be seen in such material as has been mentioned above, also very strikingly in the seed pod or in a bud of a flower when a section is taken. The material chosen

should be full of motives which are beautiful in themselves and which if placed side by side and repeated in a circle or a square will make a fine pattern or a beautiful spotting.



Chapter XXXVII

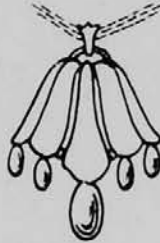
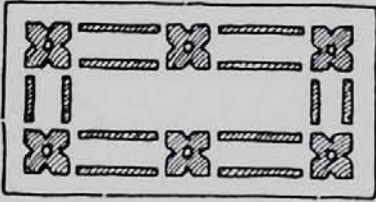
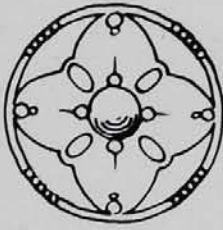
Designs Derived from Nature

*"Though we travel the world over to find the beautiful,
we must have it with us or we find it not."* — EMERSON.

IN designing jewelry we may use abstract elements which of themselves have no definite meaning nor suggest any natural form, or we may go to nature and use plant, bird, marine, and insect life, for suggestive motifs. However well the student may know and be able to represent natural forms he cannot use them as designs in any material unless he adapts them. Adaptation is the key note to applied design. When the motive is adapted, it forms an integral part of the material employed and the transition through which it passes is called conventionalization. This does not mean that the subject matter is put through a formalizing or stiffening process whereby beauty and life become extinct but that it is interpreted in a decorative manner, emulating nature's beauty, growth, and color in the material employed.

Nature's source of wealth for motives is vast and unlimited but the student cannot use them unless he has learned wherein the beauty lies through the study of such forms. The flower or other subject matter should be studied carefully line for line, turning it first one way and then another, and recording the most interesting aspects. The relation of lines and masses should be looked for and recorded when they appear to proclaim their most characteristic arrangement. Perhaps the grouping of the petals about a common center or the relation of stamen and swell of calyx exemplifies its beauty. The contour of the leaves and

DESIGNS DERIVED
FROM THE VERBINA



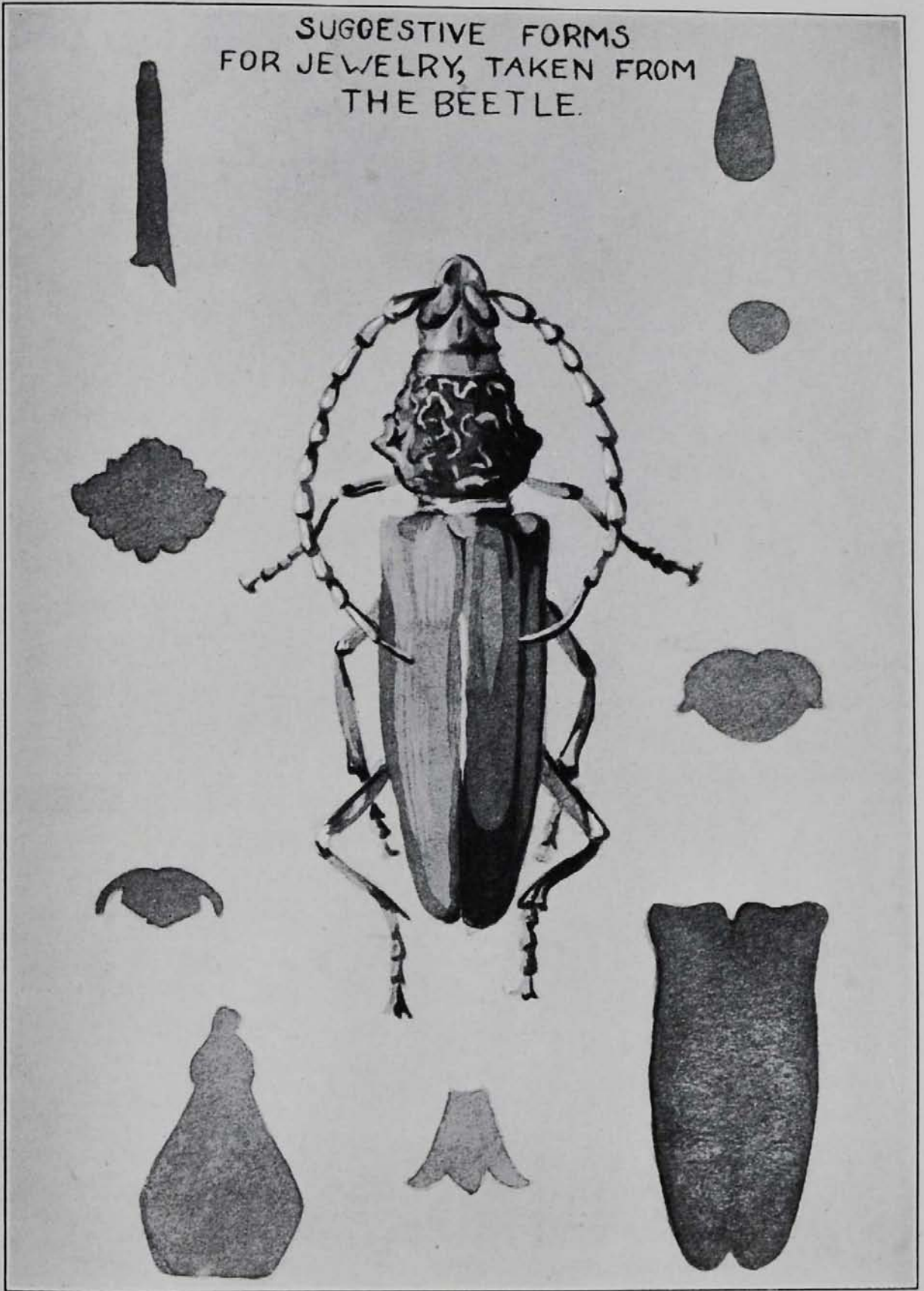
drooping of the flowers may make a strong aesthetic appeal. The beauty may not be evident at the first inspection but may reveal its charm only as the flower is viewed with careful scrutiny from different angles.

Choosing the most charming characteristic aspect of the flower calls for a sense of appreciation of fine line and beautiful proportion. It is useless to attempt a decorative translation of nature before refinement of line and space are understood. Natural forms used as decoration are never represented photographically, i. e., they are not interpreted by the effects of light, shade, and texture but rather decoratively, depicting the character as ornamental. When nature is closely copied and used as ornament art suffers a sure death. Design strives to enhance nature's beauty in terms of the medium used and does in no sense give a realistic interpretation.

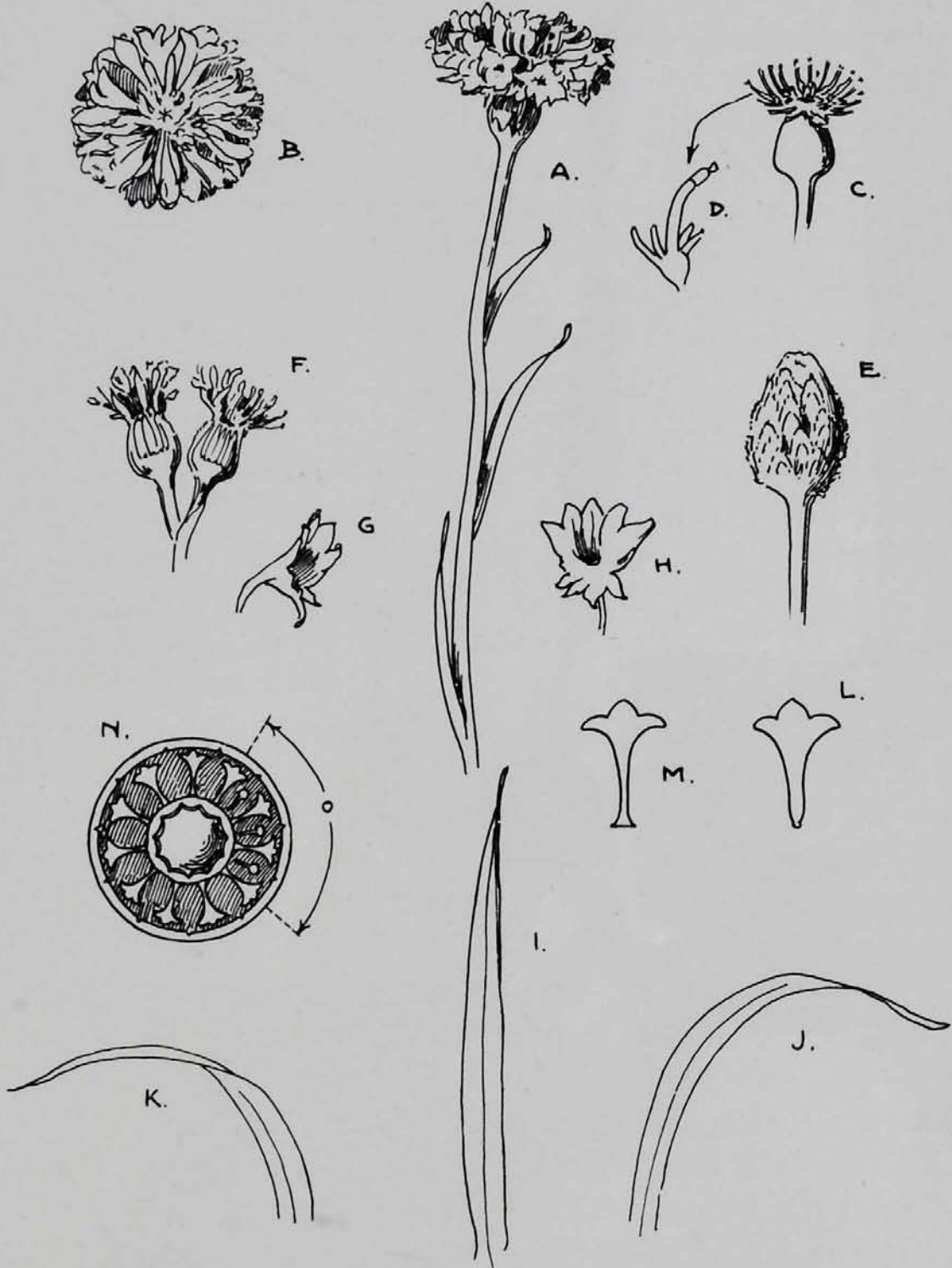
The illustrations, Plates CI, and CIII to CV, show careful drawings of sprays in different aspects representing the characteristic growth, detail of flower, leaves, etc. In making drawings such as these the student should choose those views and elements of the flower that lend themselves best to jewelry shapes. Drooping stamens with its spreading calyx suggests such forms as pendants, while the buds lend themselves freely for scarf or hat pins and drops. Facility to design from nature will depend largely upon the ability to select and conventionalize elements of flowers that have suggestive forms for jewelry. Plate CII shows the beetle and shapes that are suitable for this kind of work. It is the province of design to selectively interpret natural forms and not microscopically represent them.

When conventionalizing a naturalistic form, jewelry shapes as the ring, pendant, or brooch as well as the peculiarity of metal as a medium of expression should be constantly kept in mind. The results are first jewelry designs regardless of practicality and later they are reconstructed in terms of metals and stones.

SUGGESTIVE FORMS
FOR JEWELRY, TAKEN FROM
THE BEETLE.

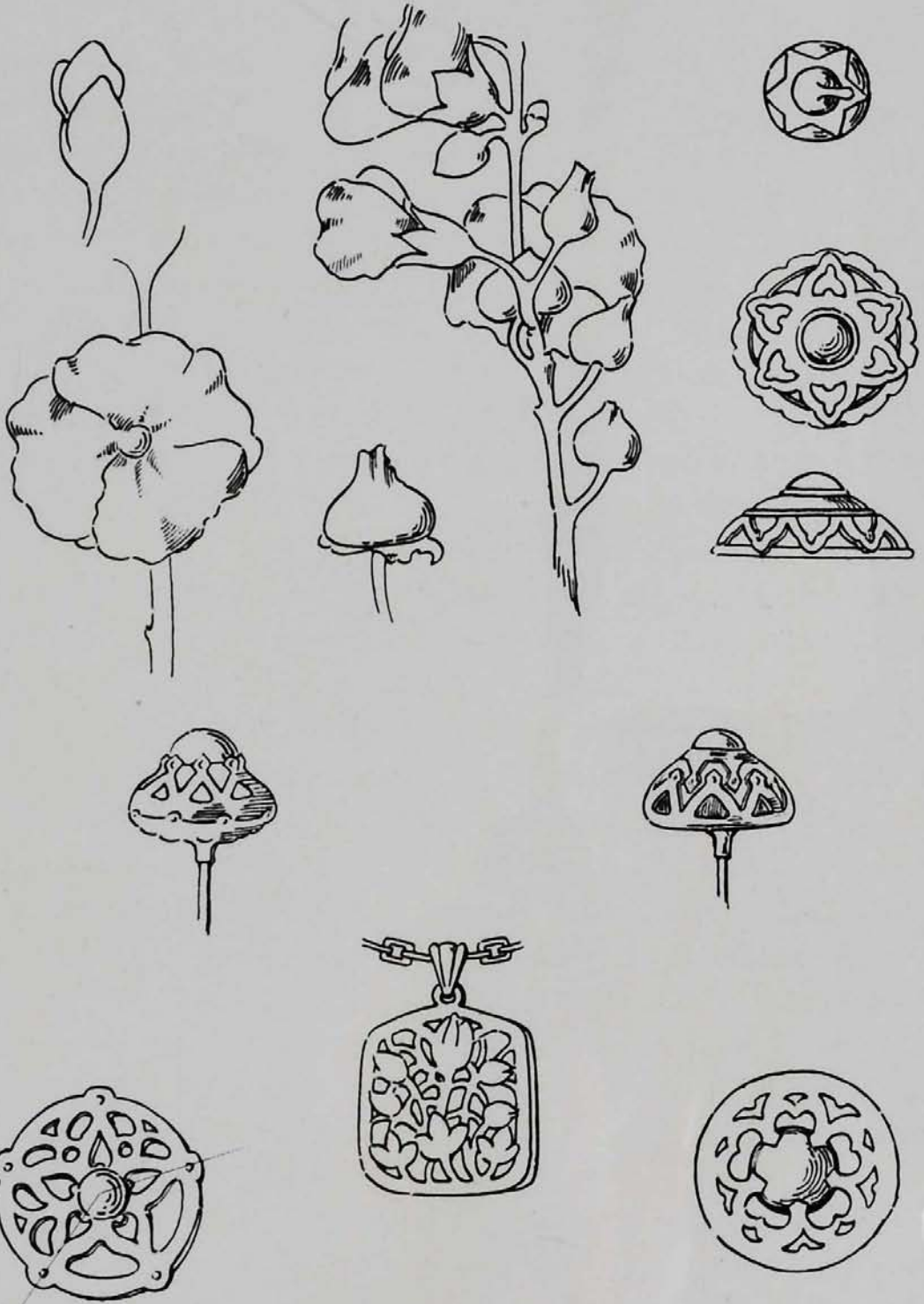


BACHELOR'S-BUTTON

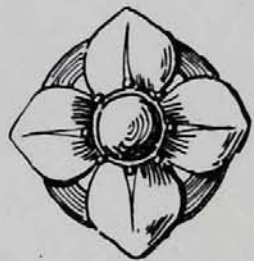
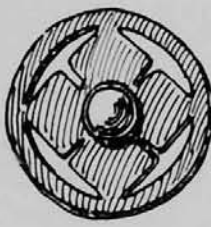
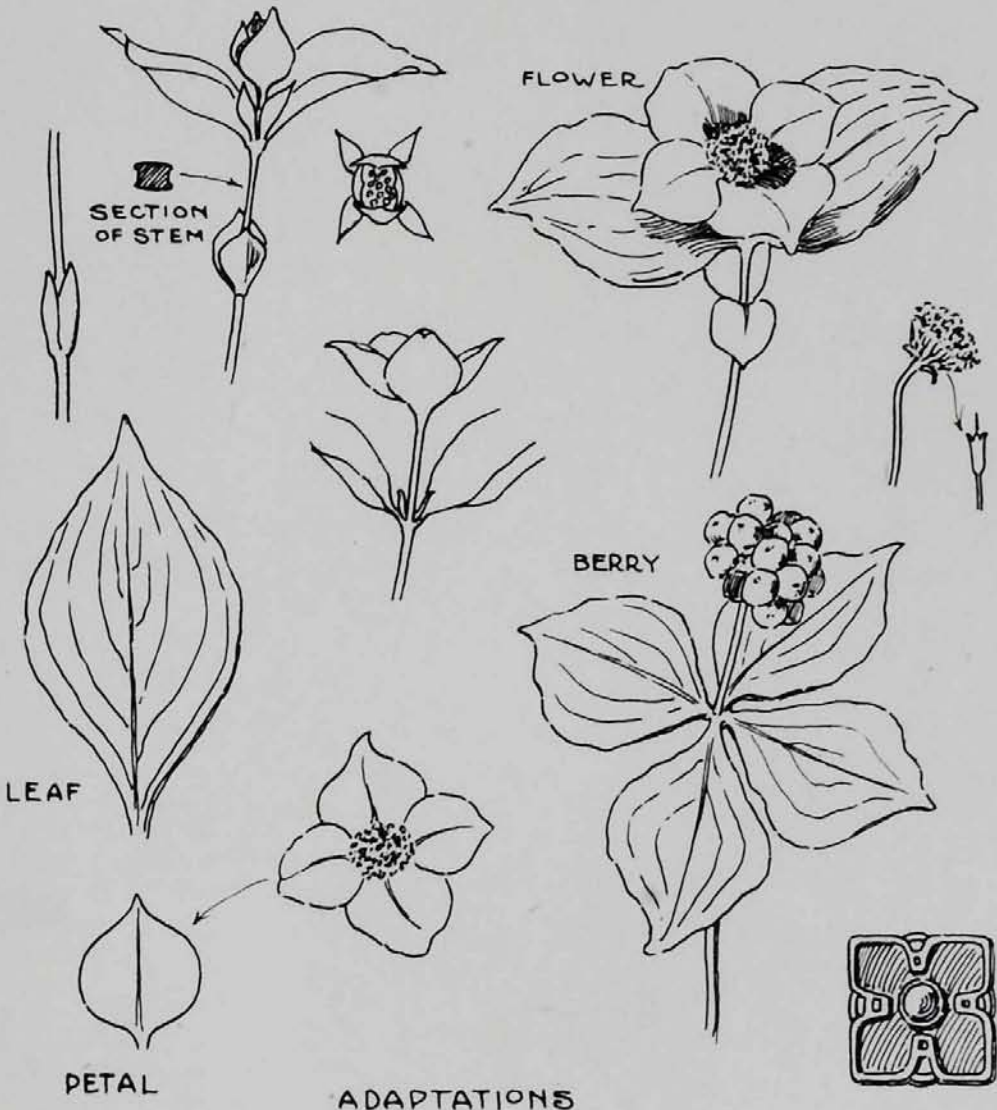


As was stated before there is no virtue in copying nature and using it bodily for decorative purposes. If it is desired, however, to maintain the characteristic features of some particular flower so that its identity is slightly apparent, the natural growth of flowers, petals, and detail used should be conventionalized the same throughout the pattern. Design demands uniformity of change throughout the scheme. If the plant form is used only as a suggestive motive the amount of departure from the naturalistic is arbitrary. It may be so highly conventionalized as to entirely lose the identity of the source, as some of the designs on Plate CIV. The proportions of the elements may be changed to suit the idea the designer may have in mind, e. g., if the unit is long and narrow and suggestive of a bar pin, it may be made short and wide through the middle or at one end for a brooch or pendant. It is quite evident in conventionalizing that it is not necessary to keep the proportion of the naturalistic form and that it may be modified to suit the needs of the problem at hand provided it is done in a fine way. In Plate CXI the manner of growth and contour of the leaves and smaller units with bell shaped flowers have been arranged to suit the outline of the pendant and brooches. These same designs in turn may serve as suggestive ideas for future designs. The illustration, Fig. A, Plate CIII, is a bachelor's button. The flower was studied carefully from different angles observing growth, contour, lines, masses and color of leaves and flowers. The most interesting aspects were drawn as Figs. A, B, C, etc. Details showing enlargement of different elements were carefully recorded, as D, G, H. For extended study, the petals were turned down and the flower opened. Drawings were then made as it appeared from the front and top. Buds were dissected transversely and longitudinally, as shown by Fig. F. The knowledge derived in making these drawings is invaluable when making conventionalized designs of them; Fig. L is formal interpretation of G, H.

IDEAS DERIVED FROM THE
HOLLYHOCK



THE BUNCHBERRY IN JEWELRY DESIGN

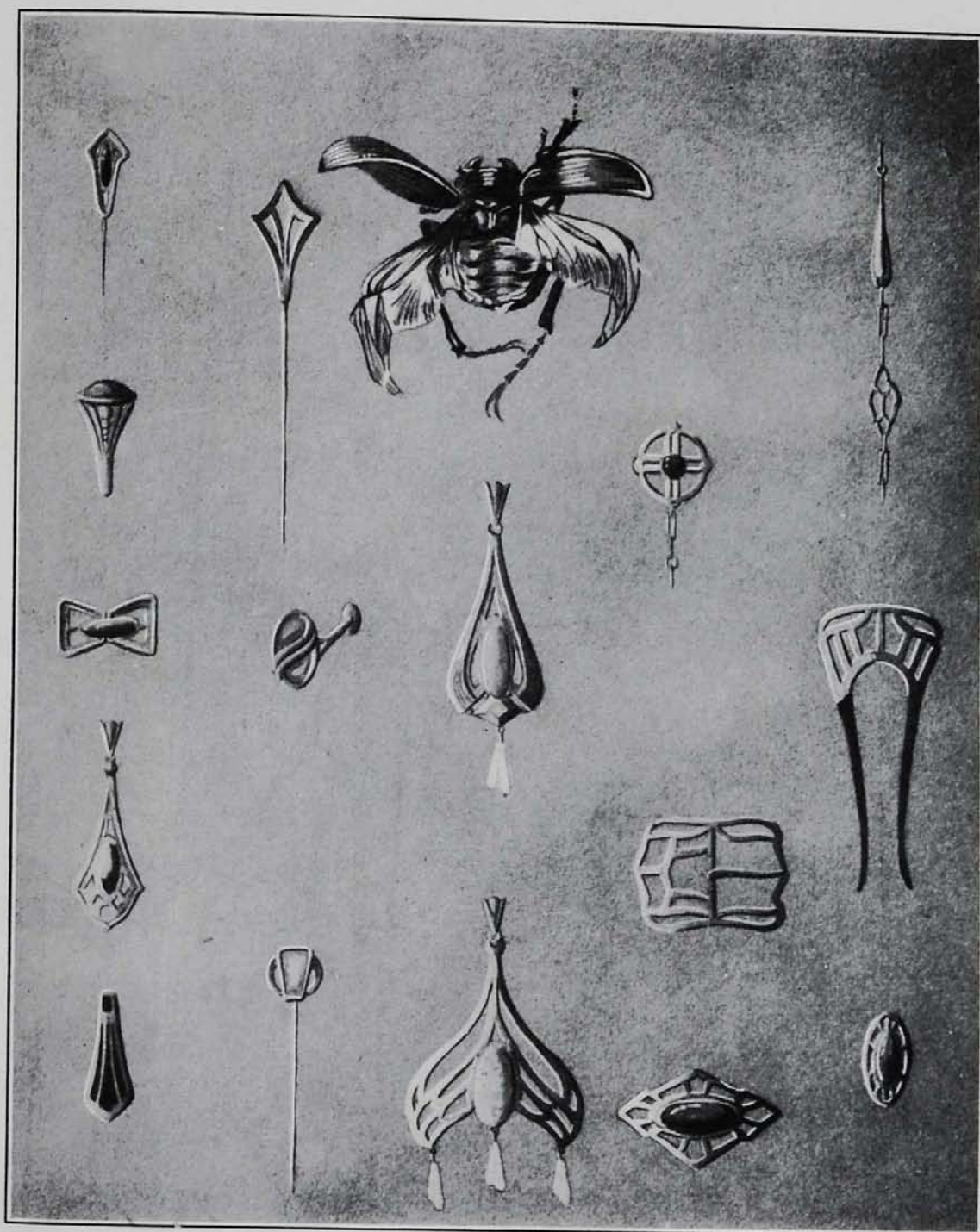


Thus far the drawings are mere records of this particular flower, although there is some slight modification in the proportion of the elements. In order to serve the purpose of decoration they must be subject to more change. They are now ready for adaptation or conventionalization.

In adapting designs to metal, the student must ever keep in mind the processes that are involved in making jewelry. Fig. A represents the flower as made up of several small units like Fig. G, clustered together about a common center as in B. This suggests a circular brooch which may be made by enameling, piercing or modelling. The unit G or H was simplified as M, L, the arrangement in the flower suggesting a radical arrangement in the jewelry. Hence a circle representing a stone as a center of attraction with these units around it at regular intervals as N. In doing this the aim is to secure beautiful proportion.

By beautiful proportion is meant a fine space relation. Two or more spaces may be in good or bad proportion according to the relation that one bears to the other. The contrast must not be too great nor must they be too much the same in area. In good proportion, monotony is absent while variety with unity reigns supreme. There is no definite ratio regarding space relation to denote when spaces are well related. Feeling and good judgment are the only guides to fineness of proportion. Differences of space is not enough to assure good spacing. There must be a fine adjustment of one space with another in order to obtain that quality in design which gives everlasting joy and pleasure.

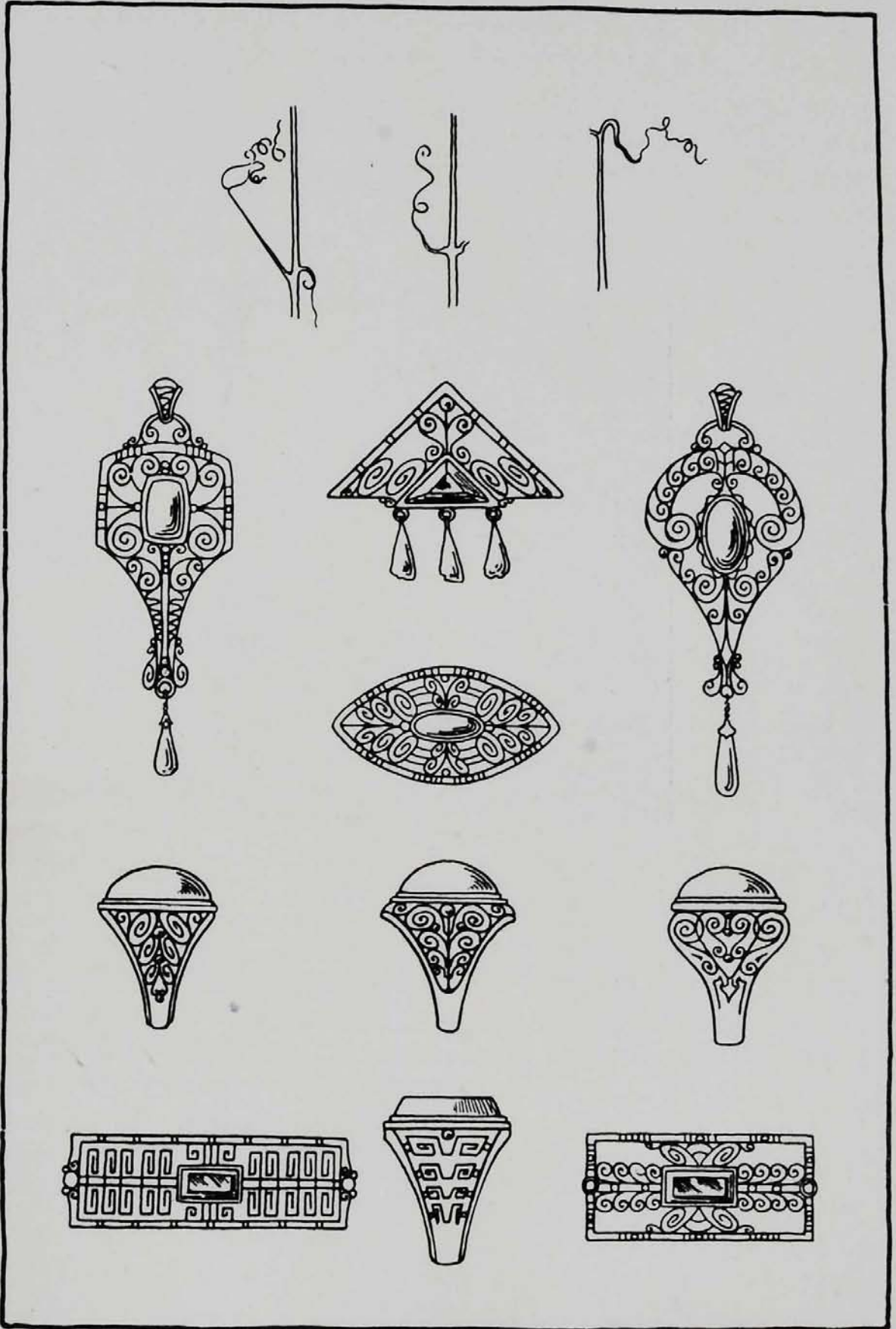
However, there is no virtue in repeating a unit over a surface unless we give as much attention to the background space that is left as to the unit itself. A fine adjustment of the units and metal left is the determining factor in securing a pleasant result. One spot should help the other and the whole should be free from confusion. If the unit chosen is too broken up and



irregular in outline, the metal left will not make a pleasing pattern specially if the design is to be perforated. We should not concentrate on the unit or spot and trust to luck that, when repeated, we will obtain a beautiful pattern in the metal that is left after piercing. The pattern made by the motifs and the metal after the motives are modified according to the process chosen should be thought of as one.

It will be seen that Fig. N has been modified in its repetition and a unit added. The unit was improved when it was spread at the smaller end, as Fig. M. The change modifies the background space and helps to create a pleasing pattern in the metal part. In Fig. N a unit was added because it was felt that there was too much metal, the design looked heavy. The additional unit is seen in Fig. N at O. The change lightens up the whole pattern, which, as it is, may be pierced, enameled or chased. Whatever process is employed at this stage the design has the appearance of being unfinished around the rim. A flat wire with nicks to relieve its plain effect or a line raised from the back will greatly improve the design. The bezel can also be modified to carry out the floral idea if it is curved on the edge as in Fig. N.

If this same design is to be chased the motive should be modelled only slightly above the surface. This element may be used less conventionalized so that the identity of the flower is more distinguishable. The unit may be a little more than the silhouette used in the pierced design. It may contain the characteristic turn of the petals and some of the light and dark effects, and adapted to the flat surface of the metal in bas relief. It should be remembered in designs of this kind that the more detail is represented in a single unit the fewer the times is the unit capable of repetition, and vice versa. The reason being that the more attraction it possesses, the fewer times it should be repeated. Plate CVII represents designs derived from



a tendril. It will be noticed how the spiral stems have been used in varying proportions, and modified to suit certain chosen shapes. This tendril is suggestive of many beautiful wire pieces of jewelry.

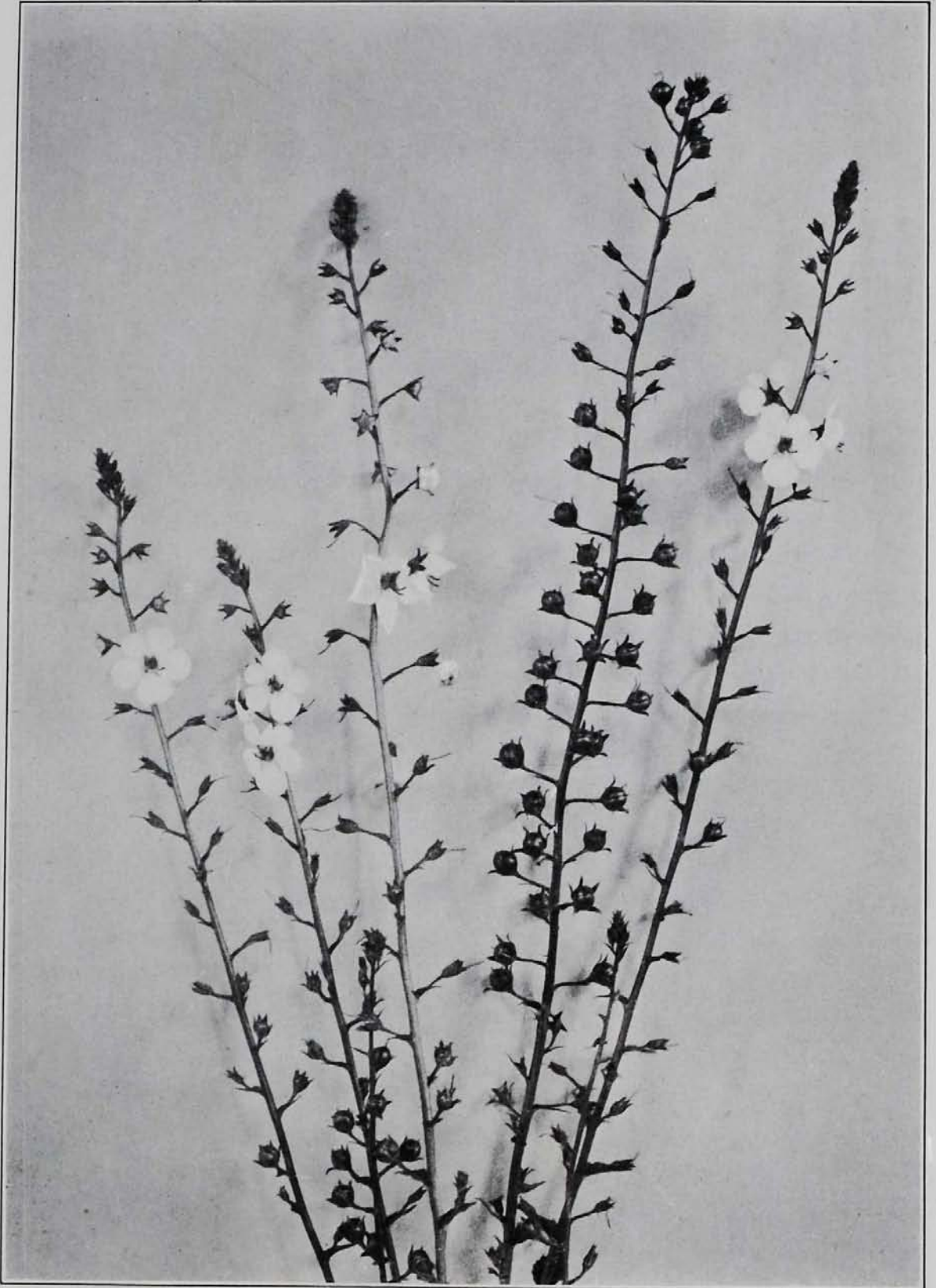




The Moth-Mullen in Design

IF we would keep our work alive and full of spirit we must revert to Nature, the inexhaustible source. Plant life alone offers a vast store-house from which the designer may draw inspiration and suggestions for ideas. Plants are endowed with shapes, forms, and colors that guide us in our endeavor to interpret them in terms of practical results. The vast number of motives that may be elicited from a single flower is beyond the conception of the untrained and at times is even amazing to the designer himself. Everything in nature, regardless of its importance, has a message for the trained observer. Small plants of insignificant size or color may stimulate the keen student of nature to produce wonderful results. Material which would not attract even a passing notice by the layman is often the incentive to beautiful and exquisite creations. But, as was intimated in the preceding chapter, whatever is used as motives to create beautiful patterns must first pass through the imagination of man. This is a process of change, adjustment, adaptation, and elimination that the flower goes through before it realizes its final expression.

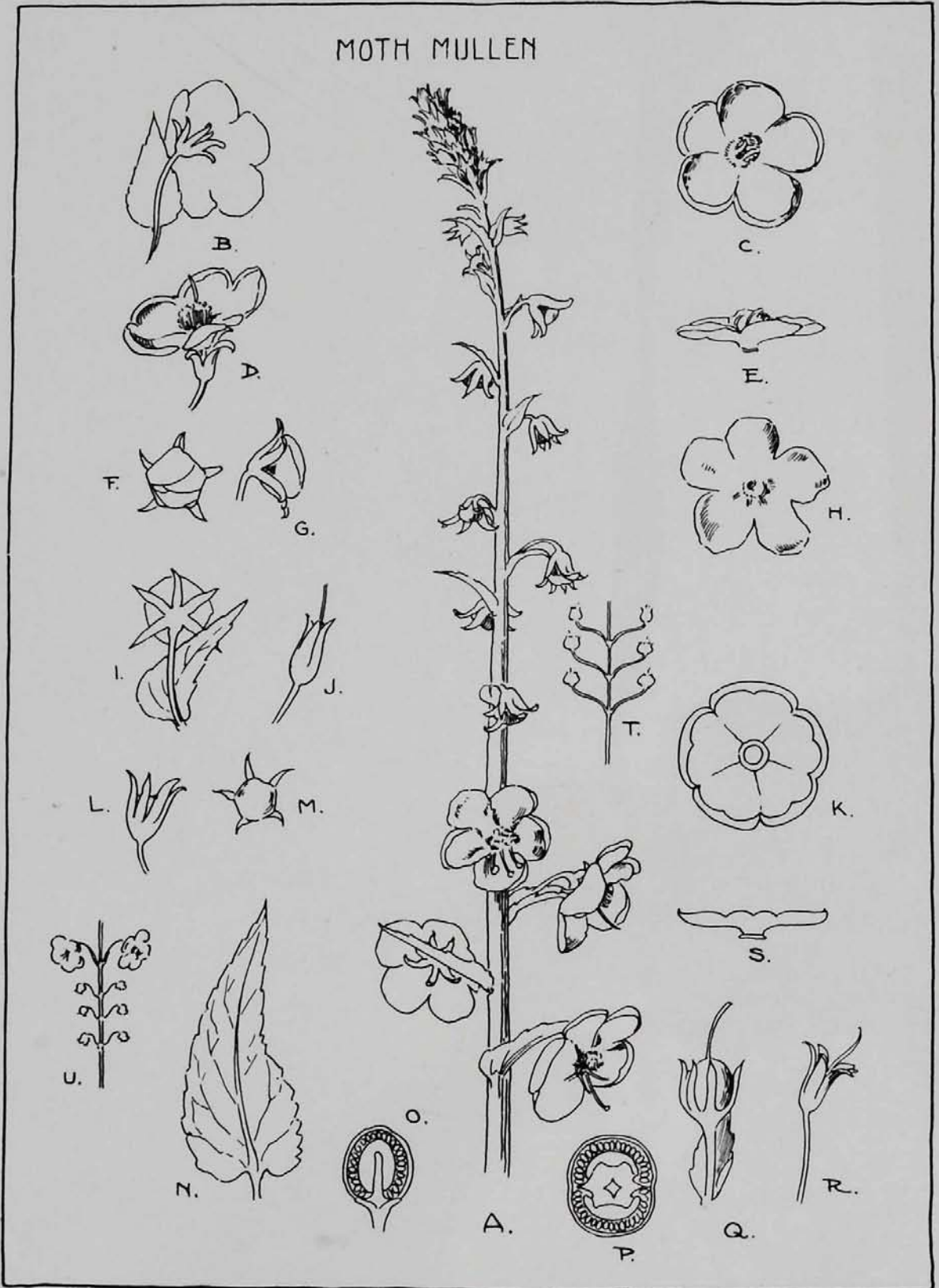
For our motive this time we have chosen the moth-mullen on Plate CIX. The designer who is quick to see the possibilities for designs at a glance can record the changes as decoration, without necessarily drawing out the different steps of approach as represented by the designs on Plate CX. This thinking process that goes on in the mind of the designer is demonstrated by the drawings on the plate



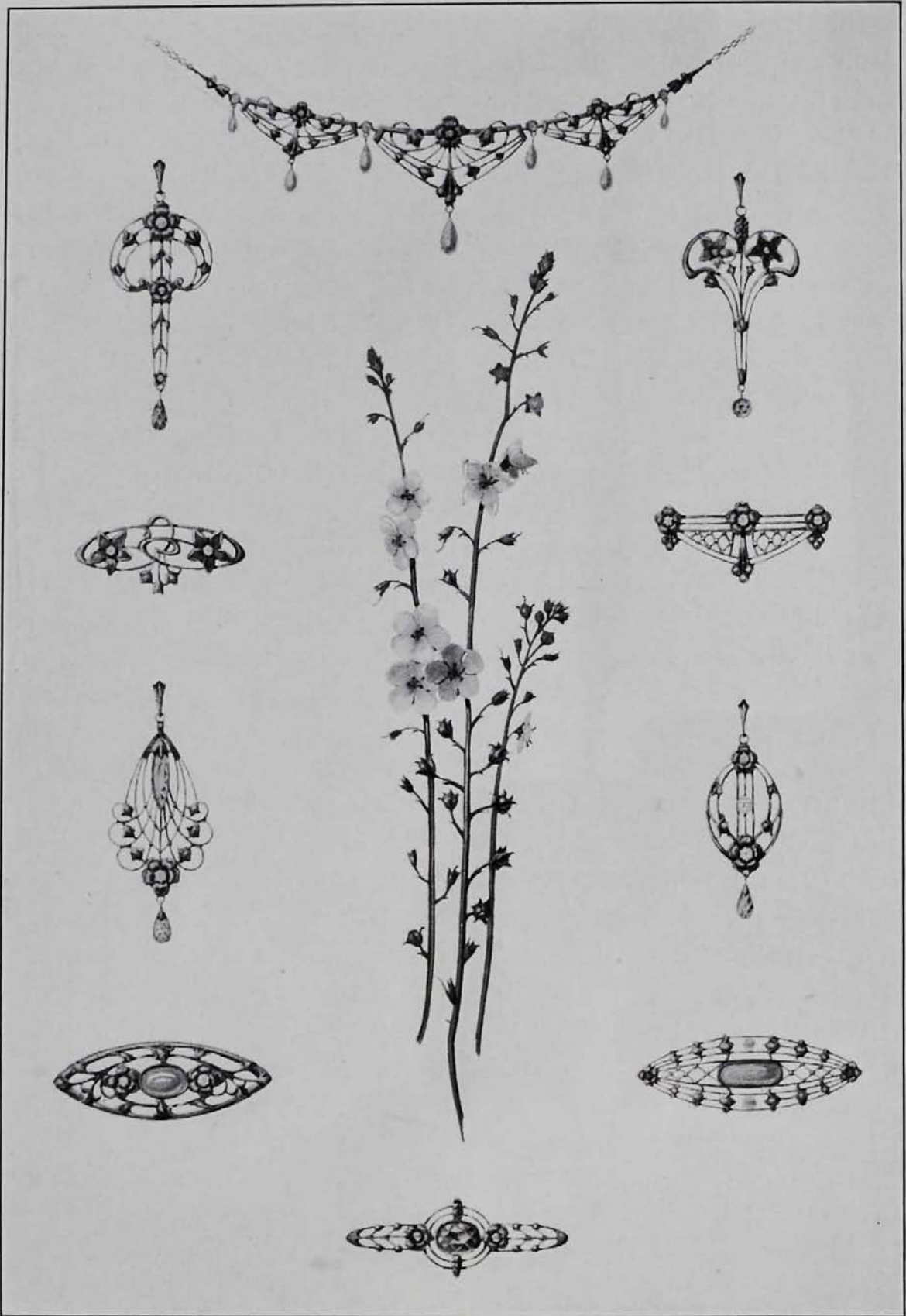
The Moth-Mullen

just mentioned to make clear the mental process involved when conventionalizing. When the external parts that have possibilities for design have been recorded, when each part has been drawn from different points of view in order to give the most interesting aspects, we should go farther and look beneath the visible parts of the flower. We now seek to get the beauty that lies hidden beneath the surface by folding over the leaves or by making sectional drawings of buds, flowers, and seed-pods. The cutting may be done with a sharp knife by passing it longitudinally or transversely through the bud or whatever part of the plant is used. A careful examination of the result will reveal the mysterious way in which order manifests itself in nature. The drawings, as represented on this plate, at once suggest many ways of adaptation. The various parts of the plant were studied for an idealistic interpretation rather than for a realistic representation. To the student who is versed in the craft for which he is designing, such drawings open up a vast field of ideas. These drawings show the parts of the flower that appealed to this student, to another student the selections might have been entirely different or translated in a different temperament or mood. These may be reconstructed for jewelry according to the ability of the student to display them with fine proportions and dignified contours. The designer sees possibilities of using it first in various ways and to this end tries many schemes of arrangements. As far as the plant itself is concerned it may not be beautiful, but it is what the designer brings to it, in the way of knowledge as to how it may be adapted, that is responsible for the beauty attained after all. The designer creates beauty out of the material at hand regardless of its inherent qualities. To this end he exerts his untiring efforts to change again and again in order to achieve an expression of beauty with the flower at hand. He subjects the plant to many trials

MOTH MULLEN



and errors, without necessarily interfering with its life or liberty, until some satisfactory arrangement or adjustment is brought out. The success of the result, however, depends entirely upon the temperament and ingenuity of the designer. He may ignore traditional methods and principles and achieve creations that defy the highest authorities, or he may use them in a formal or commonplace way and evoke only a casual commendation. By ingenious methods he may create works of art from the common place material. This ingenuity is a power in the individual which asserts itself in every line, every mass, and in every pencil or brush touch that the design possesses. The jewelry designs on Plate CXI have been derived from the same flower as shown on Plate CX. A careful drawing of a spray was first made to become thoroughly acquainted with the flower. The steps of conventionalizing the flower and its parts has been omitted in this plate and only the designs represented. They show clearly the part of the plant that received the most attention and consequently the part adaptable for jewelry. The way these stems typify the shape of the stone, their downward or upward growth, deserves no little attention. The translation of flowers, leaves, and buds into metal and stone is made in a thoroughly clear and simple way, there is no confusion as to growth or arrangement; each part is related to each other and to the whole. The stones used have been made to harmonize with the quality of the design. It was deemed necessary from the very outset to make the designs depict the delicate nature of the plant. The rendering of these designs indicate the forms and relief, and consequently point to the technical process necessary to reproduce them. During the designing process this was kept in mind and strictly adhered to. We might reconstruct these same designs in terms of another method of realizing them as by perforation or by enamelling. The method of execution plays an important part in the designing process.



The contour of the different designs, however, was not suggested by the plant or any part of it. They are simply the results of knowledge of jewelry shapes. The motive for decoration, however, was taken from the plant as is evidenced by the character of the designs. These motives, namely flowers, buds, and leaves, were adapted to the shapes selected according to the arrangements described in the chapter on structural elements. The massing and grouping were done according to principles found in nature as rhythm, balance, symmetry, and radiation. Rhythm is quite conspicuous in the small bud-like forms as they decrease or increase in size. Their arrangement around the stone accentuates the interest enough to make it the center of attraction. The lines of the brooches and pendants show how the stems have been changed from straight lines to conform to the shape of the jewel desired.

When we have done all we can with the plant we may turn to the designs just made and make many variations of them. After having made designs direct from nature and in turn having made variations of these designs we may look back with pleasure to the original source of inspiration, Nature, with a heightened feeling of reverence and respect for her humble objects.

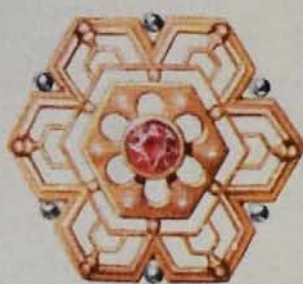


Chapter XXXIX

The Snow Crystal in Design

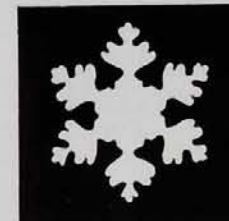
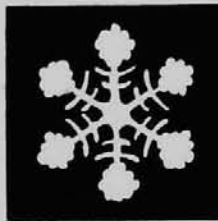
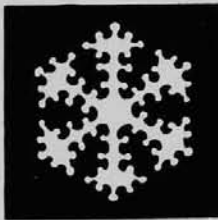
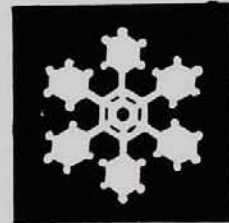
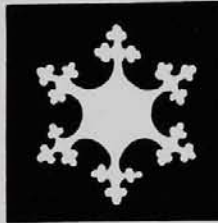
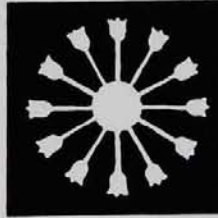
A STUDY of the three vast kingdoms of nature, namely the animal, vegetable, and mineral leads us to adopt the Platonic theory, that nature proceeds by geometry. This would convince us if we were to make careful microscopic examination of some of her small forms.

In this exercise we have taken the common snowflake that is so familiar. We know what beautiful effects the snow makes in winter as it covers the universe with its white mantle, but few of us have taken the trouble to study the minute and perfect geometrical structure of the evanescent snow crystals. These crystalline masses depend upon the degree of cold for the perfection of their geometric forms; the colder the atmosphere through which they fall, the more perfectly defined are their designs. The drawings on Plate CXIII indicate a few outline patterns from the handwork of Nature, while the one used in Plate CXII shows the modelling with detail. It is clear that their construction varies in design; this variation being due to a condition of the atmosphere other than that of temperature. But if the designer is not interested in the cause of their formation his keen observation must be arrested by their wonderfully beautiful designs and by the ideas they may suggest. In no form of nature that we have studied thus far, do we find shapes that approximate ready made designs as do the snow crystals. If we were to take them literally and apply a stone in the center, an edge to give the outline a simpler contour, and proceed to represent it as pierced or



enameled we would have, in most cases, a pleasing result. Although there is not much effort spent on the part of the designer to create beauty it gives us an appreciation of patterns made by nature. These crystals on Plate CXIII are set in their construction, hence we call the patterns geometric. They are not so pleasing as figures that are free and have less symmetry in their composition. But it is not necessary to take the crystal bodily and use it as was formerly suggested. We may concentrate on some one part of it and use the motive in any shape we may have in mind. This is much more difficult than repeating the same unit radially several times around, but the result has more artistic merit. This is clearly seen in the designs of Plate CXII. The crystal on this page has been partly rendered, giving its intricate pattern on the surface. The first idea that this crystal suggests is a hexagonal brooch, as is indicated by the hexagonal design. Upon examination it will be seen how much this brooch design resembles the natural snow crystal in its composition; as some of the units are used bodily, the design is only informally conventionalized. The pearls filling in the angular spaces made by the diverging lines show how the designer is able to overcome unpleasant conditions in the parts that do not permit any change. It is a matter of bringing in knowledge of the jewelry craft to aid in improving such places. Note how this same design has been worked out in the elliptical-shaped brooch at the bottom of the plate. Here the same motive has been used, but instead of being identical in size, it has been varied to suit the shape chosen. It makes a more pleasing design, because there is more variety in size among its similar units. The pearls have not been used in the angles of the contour, since there are but four in number, using them would create four disconnected masses holding the eye in fixed positions. Note in this design how much more attraction the stone has, with its size increased, than in the

SNOW CRYSTALS
SUGGESTING PATTERNS FOR JEWELRY



hexagonal one. Note how the design has been greatly simplified, although compared in parts it has many shapes and masses in common with the natural form. The design in the upper right is suggested by the inner part of the crystal, by the white lines that cross each other and enclose dark small masses of various sizes. This spot appears six times around the crystal while here it is used but four. A circle was made and then these lines were drawn to radiate from four diametrically opposite points on the circumference. As the circle was simply for construction, it was erased and a four-pointed star, enclosing a circular stone, was made to take its place. The contour was simplified by adding metal areas between the four principal units. This necessitated the addition of other lines as well as the pearls. In the design under this one, it will be seen that the horizontal units at the extreme ends are similar to some in the crystals and to those used in the hexagonal design, although somewhat modified in their outlines. The vertical motive can easily be distinguished in the hexagonal one and its variation, namely the elliptical brooch. In this design, however, there are but two of these used on the vertical axis, the other parts of the design have been devised to make up a harmonious result. This design is conventionalized to a greater degree than those just described. The design to the left is a variation of the one in the upper right and has very little in common with the snow crystal itself. It will be seen that the method of making ideas from nature becomes more and more formally conventionalized as we proceed in the evolution of design.



The Sea Horse in Design



FIGURE 202

IT really matters little how elaborate a motive or how humble a natural form one may choose; in the hands of a designer the most pretentious and artistic designs may be evolved from very commonplace subject matter. It is true that designs of some sort may be derived from almost anything in nature provided one possesses the ability to construe them in terms of material and art principles. The rain, snow, or wind may inspire designs which combine abstract and natural elements in a symbolic manner. The waters of the deep sea with its foam and whirlpools may be

combined with marine life of charming colors in such a way as to give rise to most fascinating designs. The material itself is but a suggestion for an idea, and nature, beyond its laws of growth and arrangement, can do nothing for us in adapting it. This is the part that man must play in his endeavors to create beauty.

Nature stands ready to surrender to man her wealth of subject matter with all its mysteries. She leaves it for us to rearrange, modify and choose according to the dictates of our best thoughts, thus creating

a nature all our own. Nature gives us the material from which it is possible to create beauty, but unless we approach her with laws and principles of harmony, balance, rhythm and the knowledge of how to use these, our efforts will be in vain. This nature made by man is an effort to realize some ideal to which he aspires or to idealize some reality which fascinates and charms his emotions. It is the province of design to express a thought in the language of line, dark and light, and color through the medium of material things. Those designs are best which are animated with the spirit of the subject they attempt to express and which meet the purpose intended. The design must construe the idea or present the impression on the mind in a simple, clear, and yet in an artistic way. For the purpose of demonstrating that it is an easy matter to evolve designs from the commonplace things in life we have selected a sea horse, Fig. 202, a subject not beautiful enough to arouse any contradiction.

The sea creature with its curled tail, peculiarly marked body, and its horse-like head is a real curio. We might investigate into the life of this animal and find that it swims and crawls among sea weeds, clings to marine plants, and that they are found clustered together by virtue of their curling tails. All this aids in explaining their different shapes and forms. With a knowledge of their life and habitat the student is prepared to interpret the curio in terms of art principles. It may be used in a very formal conventionalized way or it may be so highly conventionalized as to lose its identity altogether. Fig. 203 shows one article in which the sea horse has been used for a hat pin in a very informal interpretation. The two sea horses here wind about each other as they often do in life. This arrangement was suggested by a study of the living subjects. As it presented itself in this aspect it needed little change to see it in the light of a possible hat pin. This same arrangement, with a



FIGURE 203

little stretching of the imagination, may be adapted to the shank of a ring as is represented by the cast in Fig. 126. The treatment is rather naturalistic since there is but little modification in its form. When they were designed for the ring they passed through slight changes in order to conform to the peculiar shape of the shank of the ring. After the sea horses were adjusted in place, an empty space was created between them that demanded due consideration. The motive to be used for such a space should bear some relation to the ornament already employed. The question first asked was what kind of motive may be used that will be consistent with the idea already expressed and at the same time fill the space adequately. The naturalistic treatment of the sea horse is well apparent so that whatever natural form is used it must also be conventionalized to the same degree. After much thought and search for a motive it was deemed wise to select something from the fish's natural environment and nothing seemed more appropriate than a sea weed. This was carefully studied and drawn in its various positions to secure the knowledge which is necessary to enter into the spirit when designing. When it became familiar it was drawn between the sea horses, allowing it to come gradually from the shank of the ring as though it grew out of it and to attain full growth between the fishes. Thus we have used this humble subject in a rather informally conventionalized manner, retaining to a large extent the character of its features and at the same time we have interpreted them in terms of metal as a means of decoration for the finger.

But this is not all that is possible. If we can think of it in its simplest form, merely its contour, and then simplify it still more we can use it as a motive for repetition in a circle which, when arranged on the right and left of a stone, makes an attractive bar pin.

The curl of the tail makes an excellent spiral and is easily applied to many forms of jewelry. If the spiral tail is accentuated we find it will lend itself to many forms of jewelry, producing exquisite designs. This part constructs one of the vital curves that was mentioned in chapter XXXV and which is capable of so many applications. The stones chosen should be suggestive of the environment of the sea horse.

Careful study of the body discloses many interesting shapes. The rectangular shape figure, in which is inscribed a diamond, is repeated over the body in decreasing and increasing measures. Although each spot resembles the one above and the other one below yet it varies to such an extent as to suggest a different idea or motive. The motives seem meaningless at the first impression to stimulate any aesthetic feeling for design. However insignificant the motive may seem it should at least be given a passing consideration; this becomes a good test for the designer to display his ability in creating ideas and his ingenuity in adapting them. In spite of its humble character this motive is used to demonstrate the possibilities of which it is capable. In the two rings on Plate CXIV the idea can easily be traced back to the sea horse and be readily recognized. On examining this subject again we find a diamond-shaped unit which apparently has very few possibilities for decoration. This motive like the other was not chosen because it seemed highly enriched with ideas but simply to demonstrate what is possible. It was not chosen with the hope that it might fit some jewelry shape, but the motive was adjusted to a particular article, in this case the elliptical brooch. It was planned to have the designs in wire with any number of stones. The diamond shape motive was modified in order to fit the shape of the brooch chosen. The motive can easily be recognized in Fig. C, although there are many of them in an interlacing arrangement.

In Fig. D the rectangular shape has been modified so that it has assumed the shape of an oval. This can easily be distinguished at the right and left of the large elliptical stone. The diamond in the original rectangle has given way to lines that radiate from the extremities to the central stones. Half of the original diamond shape still remains while the other half has been converted into a double-branched volute curve holding a small circular stone. The circular brooch, Fig. F, represents the sea horse highly conventionalized and simplified to such a degree as to retain only the contour. They have been clustered in pairs about a central faceted stone. As the problem was to be kept very light in its appearance and executed in round wire the motive was translated with this in mind, hence the piercing in the sea horse unit. When placed side by side a place for a small circular stone was formed between the heads of the fishes. The student should take advantage of all these opportunities that arise but should treat them with judgment and discrimination. When these units were placed on the vertical and horizontal axis, they seemed to leave much space between them, perhaps just enough to allow four more units. As it was deemed wise not to use these again in order to avoid monotony, it was necessary therefore to search for some unit that would fill the empty space and that would harmonize with the motive already used. Such a motive might be suggested by or taken from the units already in the design. The triangular shape unit selected was suggested by the opening in the sea horse already conventionalized. It has been made symmetrical and the curly endings have given way to curves that blend into the bezel of the stone. The finish which appears at both top and bottom of this triangular unit gives it the appearance of growing out of the brooch itself. Fig. E is another brooch of wire that has been evolved from the same motive, although the conventionalization of the diamond-shape motive

DESIGNS DERIVED FROM
SEA-HORSE



a



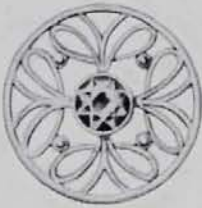
b



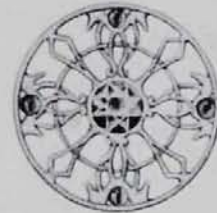
c



d



e



f



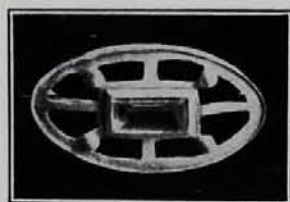
g

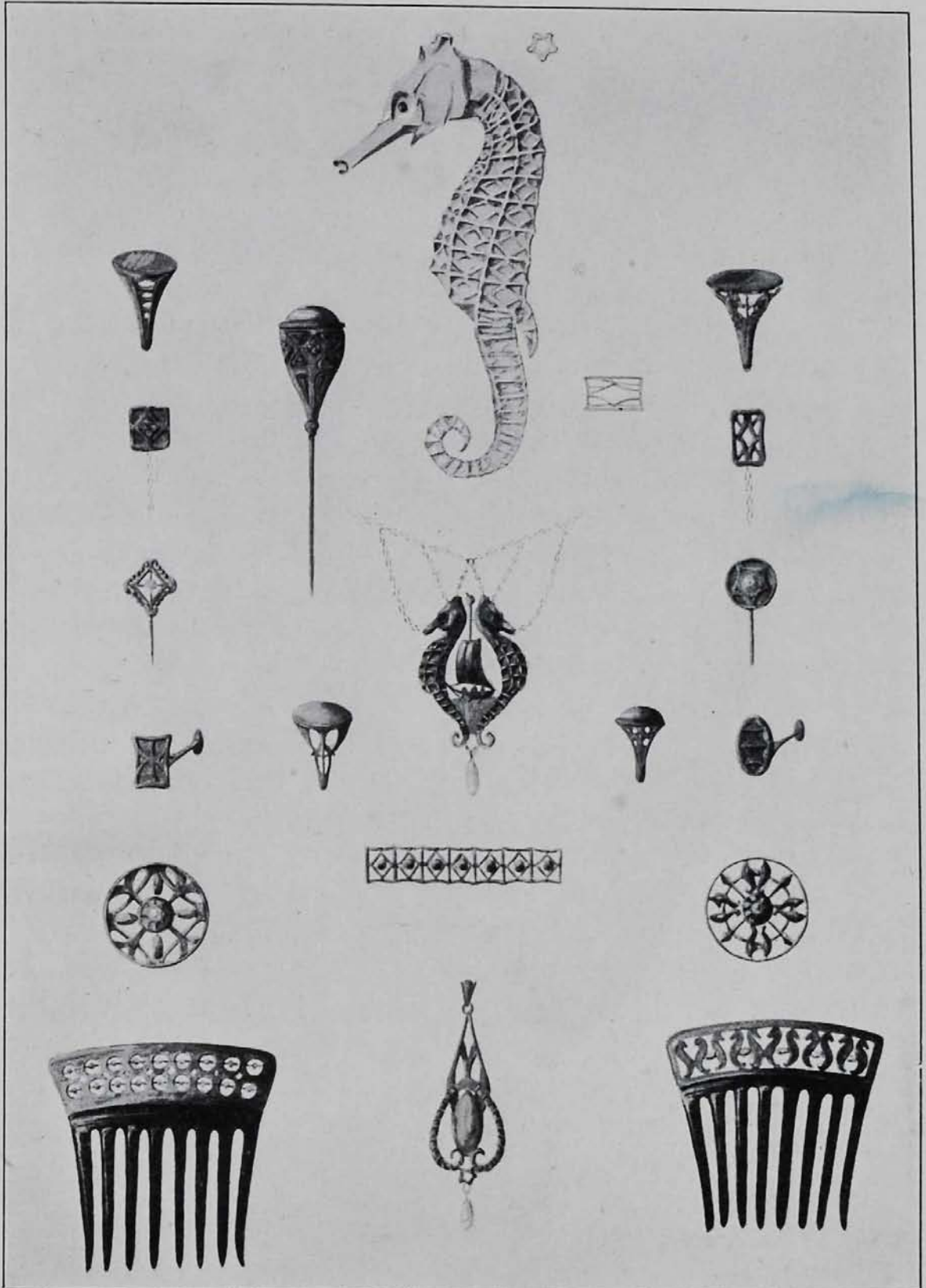


h

is very formal. Its identity has vanished to such an extent as to give rise to an apparently new unit. When the transition from the original motive is so great it may demand the introduction of other forms to create the desired result, as it happened with this brooch. The two lower bar pins, Figs. G and H, show how the same rectangular motive with the inscribed diamond figure has assumed a geometric appearance. In Fig. G the rectangle is quite long, while the diamond is made to fit the varied proportions. This unit by virtue of its proportions created a place for a gem stone. A circular stone was chosen in preference to other shapes, in order to emphasize the long bar effect of the pin. As the rim was flat and uninteresting it was enhanced by cutting away some of the metal, thereby creating a dark and light effect. These spots are square in shape, again keeping to the straight line character of the unit chosen. Fig. H makes a very interesting bar pin. The diamond shapes have been subjected to such variation as to create a motive which, when placed side by side, evolves semicircular shaped figures. The modified squares have been filled with stones and alternating spirals thus carrying out the curl of the sea horse. Interest has also been added by the contrast of stones of different sizes.

Plate CXIVA represents a number of designs derived from various parts of the sea horse.



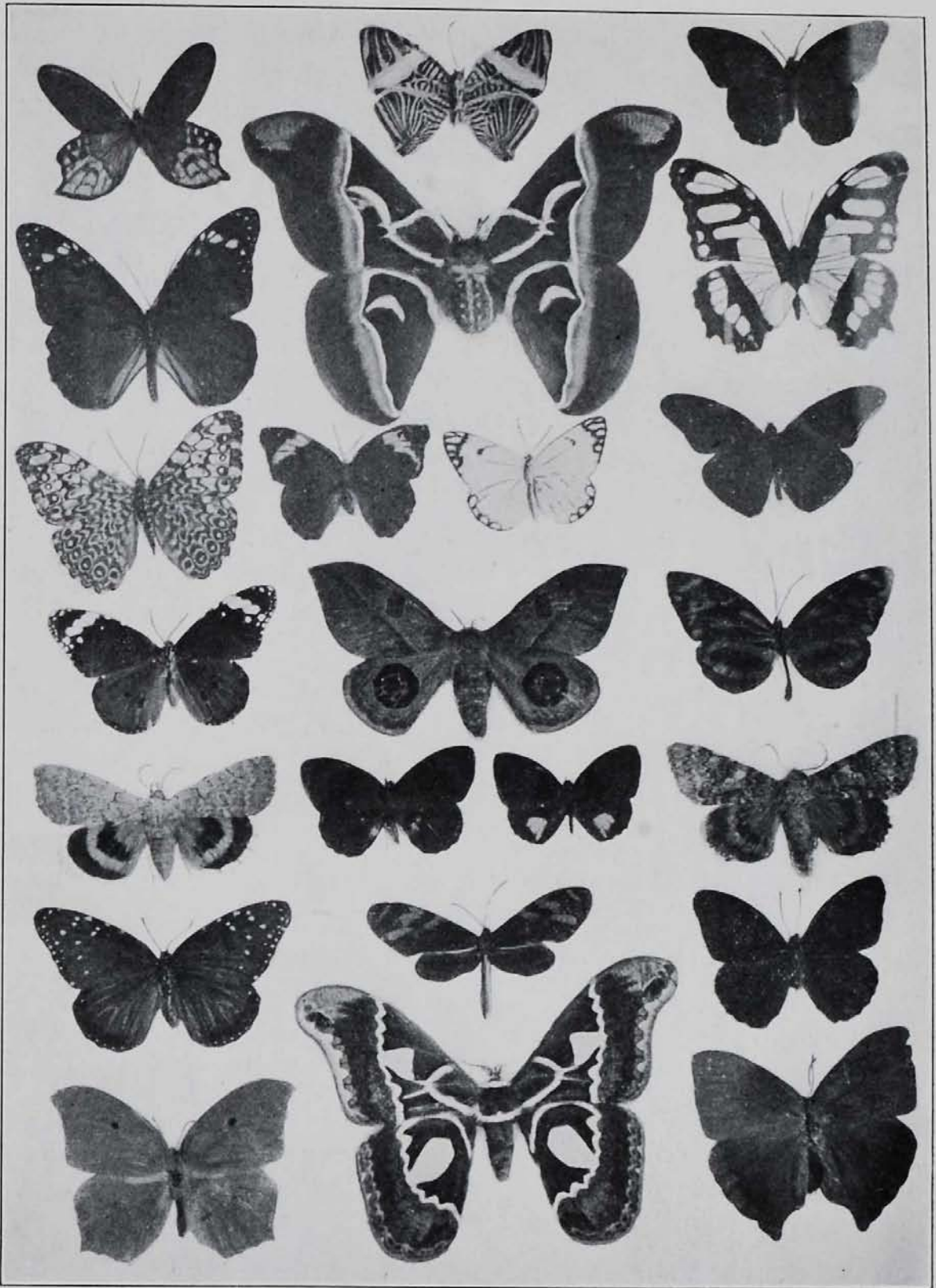


The Butterfly in Design

DESIGNING from the butterfly or from any of the sources of nature involves on the part of the student not only ability to see motives which the untrained would not see but also the ability to interpret such motives in terms of design. Copying from the different sources of nature in the foregoing problems was not suggested to the student that he might hope in the course of time to find ready-made designs. The subjects chosen were given to inculcate a feeling of balance, rhythm, beautiful proportion, and harmony of line and shape, the principles which the student will learn to use in his production of designs. While copying, the student should strive to keep these principles in mind or better to make notes of them as he goes along; and unless this is done with active attention and intense interest the copying will be done merely for its own sake and the vital aim of the problem will be entirely missed.

When designing from nature the student is asked to make an exact copy either in pencil or brush as shown by the illustrations Fig. A, Plate CXVII, and Plate CXIX, in order to gain a wider appreciation of its rhythmic lines and shapes, harmonious color, and balance or symmetry of spots. Butterflies with such beautiful spots as those on Plate CXV will be found very suggestive for ideas. The student may prove himself to be very skilful in this and yet be utterly unable to make up a design of the crudest sort even after you have shown examples and illustrated plates. The amateur cannot see how this

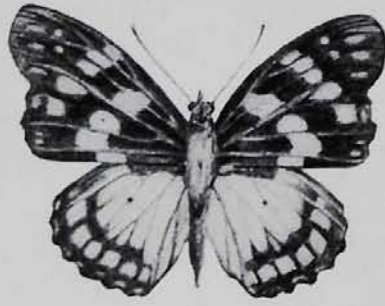




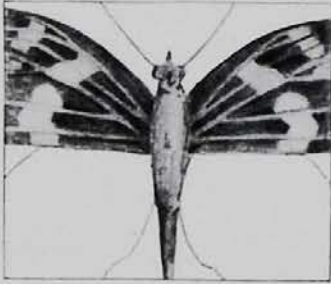
insignificant weed or that worthless seed-pod was enough to suggest so many beautiful designs. Even though the students be shown where the different designs came from, which part of the flower suggested this design and which that, they cannot sit down and make them unless a more psychological method of presenting this problem is evolved.

Plates CXVII and CXVIII show just the way the designer thinks when confronted with this problem. Fig. A is a very careful pencil drawing of the butterfly showing all detail. Fig. B shows a unit that apparently has possibilities of suggesting some idea. Fig. D shows that the unit has been simplified thereby becoming a formal representation of this part of the fly. Fig. H in Plate CXVIII still bears the characteristic features of Fig. D, but with much more formality. The lines representing the ribs of the fly have been increased in number and the upward rhythmic movement has been accented. The rectangular spots at the ends of these lines have correspondingly been increased and modified to carry out the upward direction of the lines. The upper part of the body of the fly has given way to a stone while the lower part has been replaced by a drop. The head conveniently made way for three circles which might be granulations while the antennae are curled into involute curves around the three circles. The design thus far is in abstract terms, no thought having been given to the method of execution, the aim being first to produce an arrangement with no idea as to practicalities. Fig. J shows how such a composition of lines and masses can be reconstructed or interpreted in terms of metal and some definite process of execution. The result here attained is for a pierced brooch although we might have made it for enamel or even for the repoussé process.

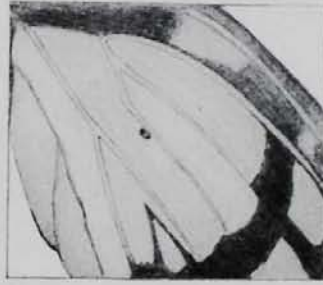
Fig. C is another part of the same fly. Part of this was taken and inverted as shown by Fig. E. By



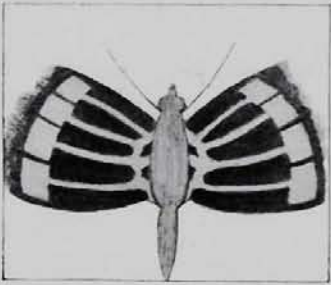
A



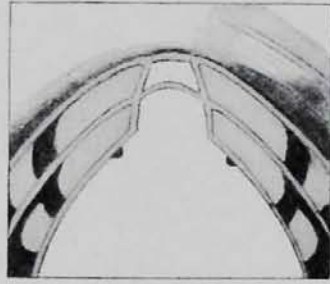
B



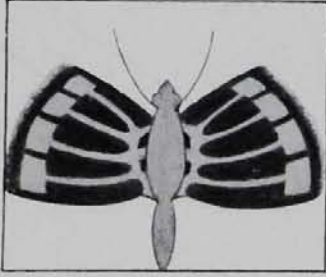
C



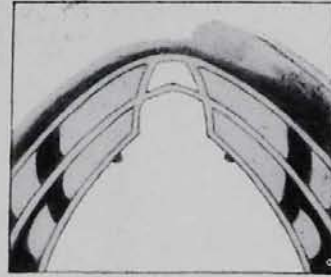
D



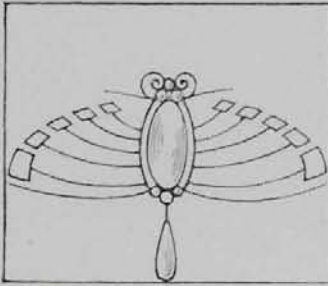
E



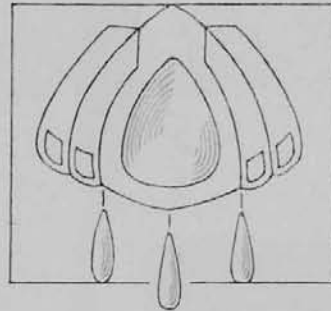
F



G



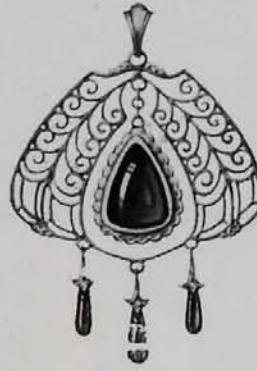
H



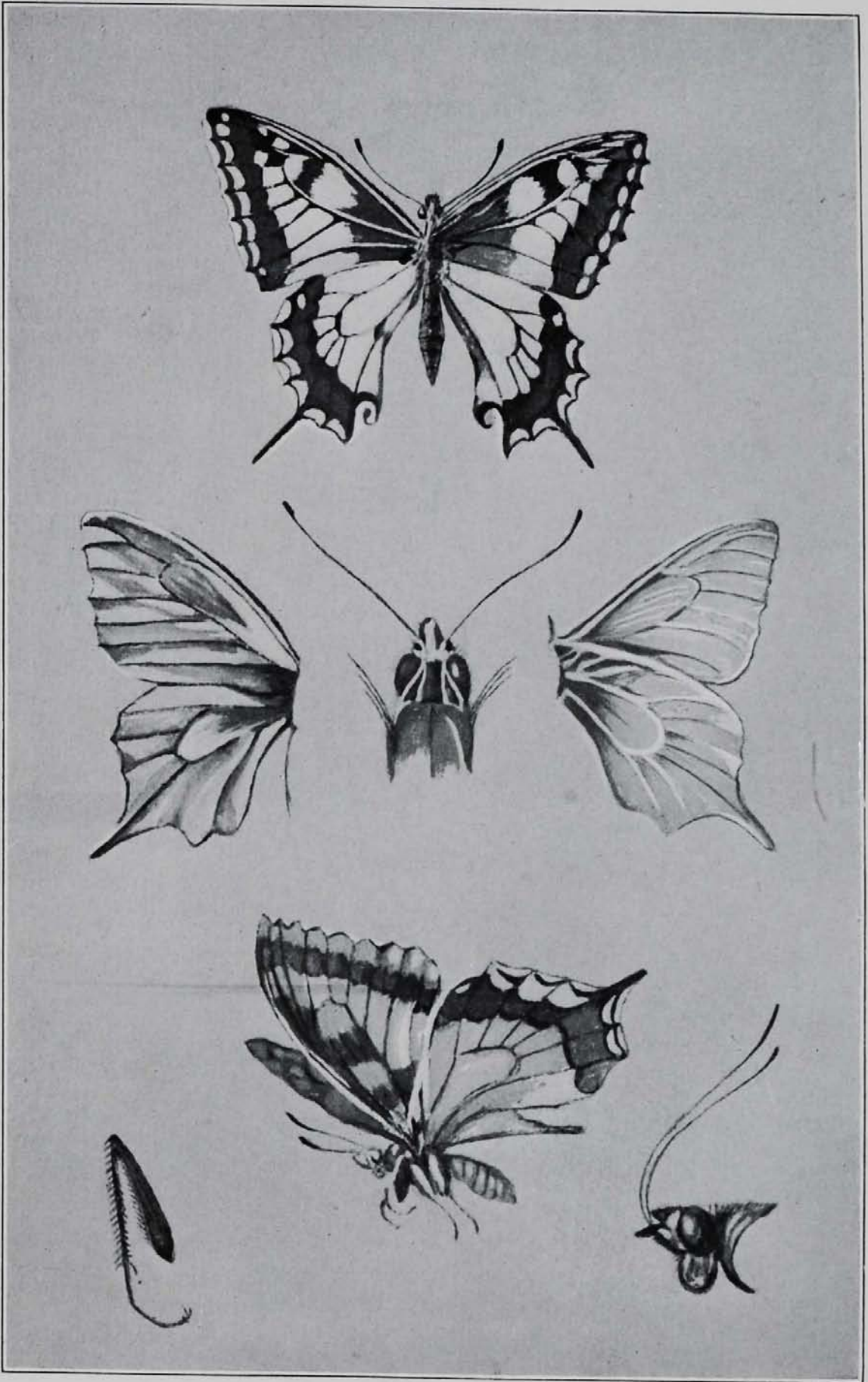
I

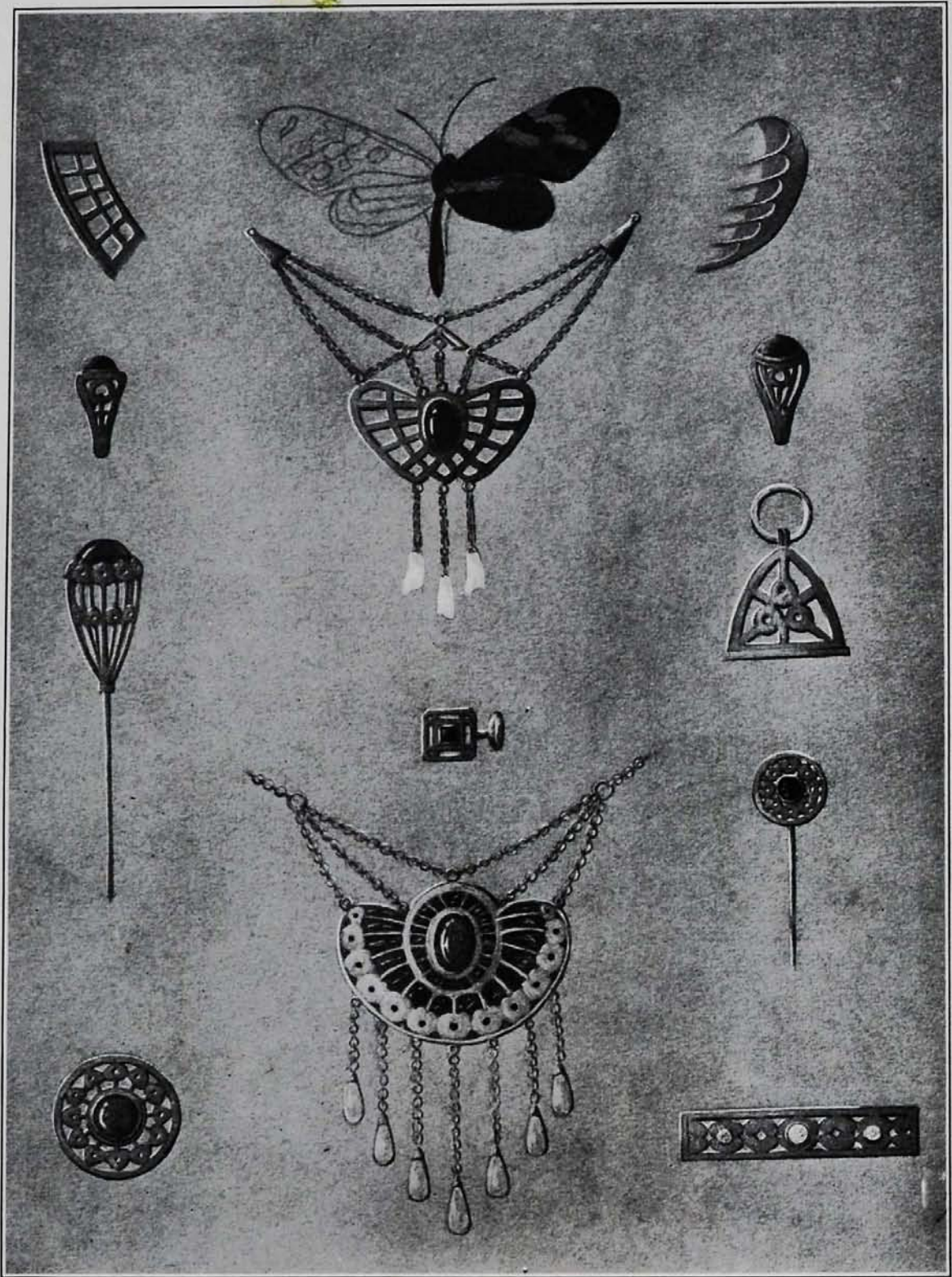


J



K





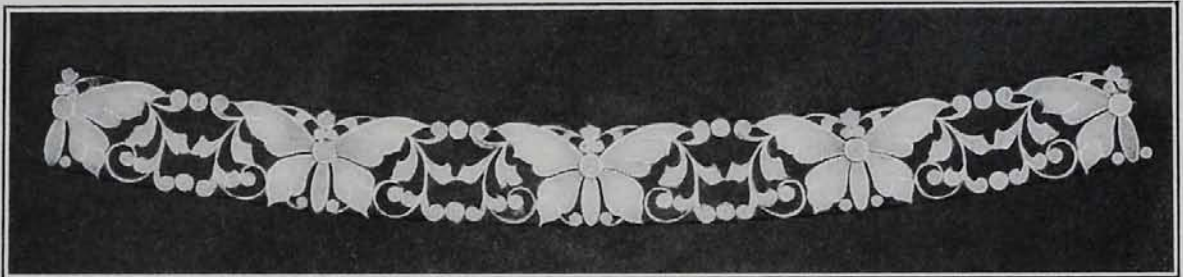
this simple process of inversion we have created a series of lines radiating downward to left and right from a common point. Familiarity with jewelry suggested a hanging of some kind, a pendant possibly. Hence Fig. I in Plate CXVIII expresses the same downward effect of these lines with some modification of the ends and the spots between the lines. These lines created an open space and it was taken advantage of by inserting a stone that echoed its shape. The three drops were added to emphasize the downward effect of the pendant. This design as with Fig. H is merely in abstract terms. It is a cluster of lines radiating downward from a common point. The design is now to be interpreted in terms of metal, stones, and a definite process of execution. Fig. K shows that it has been interpreted in fine wire. The spaces between the main lines of the design have been filled in with scrolls since they looked empty and unattractive. The other modifications and additions have been made to create a harmonious whole. The result is a complete design for a jewel which the novice marvels at, wondering how unit B or C was the origin of that beautiful design. A collection of butterflies such as Plate CXVI is invaluable for this kind of work. Plate CXIX shows studies made from a butterfly in this collection while in Plate CXX we see a number of designs evolved from the butterfly.

The question may now arise as to whether it is necessary for the student to have some knowledge of the making of jewelry in order to design practical jewelry and do it with facility. Of course it would be of great help to know how the jewel is put together but it is not absolutely necessary. When the student has made many copies from photographed jewelry, and has some creative ability, he should be able to produce excellent results.

When the student has grasped the method of attacking the problem or better the method of inter-

preting units for design, he is beginning to develop creative power that can evolve designs from almost anything. Just as soon as the student is able to look at any part or unit of the butterfly and see in it endless possibilities in design he will never be hampered for ideas, he will see more possibilities in a single motif than ever before, and his pencil will not work fast enough to record these ideas.

If this method of designing is followed the student will never be wanting in ideas since they are anywhere and everywhere if he only knows how to interpret them. Designing from nature will prevent the student's work from becoming monotonous and the method described will render the designs free from strain and overlabor; they will look fresh, possess a feeling that will tell that they were done with freedom and spontaneity. Furthermore the student will not feel like many students of design who give it up after working for a few hours because of a scarcity of ideas.





Designing the Elliptical Brooch

IN designing a brooch it is first necessary to ascertain the exact requirements and conditions. This brooch is to have a stone, cabochon preferred, and must have a design with perforations. Its dimensions may be arbitrary in length and breadth. The motive for ornamentation is to be abstract in its meaning. As stated, the abstract motive may be arranged in many different ways but must be reduced to some tangible idea in order to facilitate the problem of the designer. It becomes necessary then to state it in more specific terms, such as, motives that are concentric or eccentric, or motives radiating from the center along the vertical and horizontal diameters, or any other arrangement as suggested in the circles on Plate LXXXI and in Fig. 199. Some such conception of arrangement is necessary to create design. It should not be left to the element of chance to determine the manner of breaking up the surface. The scheme should be clear in mind and tenaciously adhered to. Suppose then that the surface is to be broken up by motives that are concentric and are intercepted by vertical and horizontal lines. The first step is to sketch a number of ellipses of fine proportion, having in mind sizes that are suitable for brooches. Next draw the long and short diameters, and then inscribe a concentric ellipse of such diameters as to make fine space relations among the areas made by the curved and straight lines. It is well to draw enough ellipses to have ample chance for experimentation. When this is done draw another ellipse in the center for a stone appropriate in size. In order to

make the exercise as profitable as possible, the stones in each ellipse should vary from a small to a fairly large size. Up to this time we have been dealing with pure line, now it behooves us to realize what we have in terms of metal and stone. Instead of thinking of them as mere lines, think of them as bands of metal of various widths and draw them as such. When this is done it will be quite evident that we have a design, severely simple, nevertheless one fulfilling the above requirements. As simple as this may seem, it calls for judgment and a sense discrimination for fine space areas.

Good spacing will determine the success of these as well as other problems of more complexity. The design must display a fine adjustment of one perforation with another, of perforations and metal that embodies them. The intricacy of the pattern should increase with each design,—instead of a single metal band radiating right and left, we might double them, creating more metal and more small spaces. Each metal band added creates additional light effect and consequently complicates the solution. But, regardless of the number of spaces created by the metal, the problem is one of dark and light, and its charm consists in its contrast of small and large areas of the right relationship. It must ever be kept in mind that the real interest is attained in the metal and that whatever perforation is made must ultimately leave a fine pattern in the metal. These ellipses should be filled by spontaneous efforts without stopping to erase errors for modifications. When a result is not satisfactory begin with a new ellipse or by tracing over the design making the necessary corrections. Each attempt should be made with confidence and surety of purpose. There should be no hesitating efforts; every stroke should be a direct result and a convincing thought. The good designs in turn might be elaborated by the use of tracing paper. This method is advocated so as to keep the original design intact. The perforation

may be modified so as to assume more shape and character. This is accomplished by adding a line or area here and there which influences the shape of the metal in which we are primarily interested.

Plate XIII A, page 61, represents a number of designs constructed on structural elements of various types to show some good examples of pierced elliptical brooches. It should be noticed in these designs that the success is due to a fine relation between the length and breadth of the ellipse, to the proper relation of openings and metal, to an agreeable contrast of small and large openings, and to the unity and simplicity of the idea expressed.



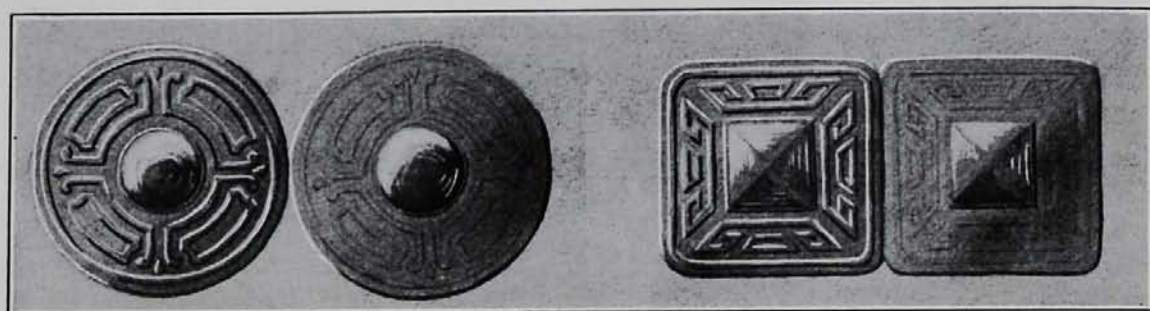


FIGURE 204

Chapter XLIII

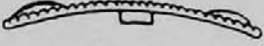
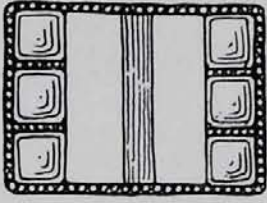
Buckles, Clasps and Bar Pins

THE buckle is made of one or two strong pieces of metal, usually with a pin placed horizontally across to be inserted into the ribbon or belt. Buckles are also used for shoes, as illustrated on Plate CXXIV with a narrow strip of metal on the under side to which the ribbon may be sewed. The pin originally used to fasten the belt has remained, soldered on to the upper surface as a mark of tradition, performing no particular function, but lending an artistic effect.

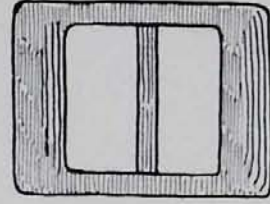
Often times this device, when used on a belt, is made of two distinct pieces one placed at either end of the ribbon. The piece at the right end of the belt having a hook, while the other has a slot. This kind of buckle is called a clasp as Fig. 204. In either case the designer must take into consideration that there is a horizontal pull to overcome and consequently must meet this condition with metal strong enough to withstand the strain. The fact that it comes in contact with parts of the garment makes a simple outline imperative. It must be free from points or edges that will cause unnecessary wear and tear, hence the simple outlines in Plates CXXII and CXXIII. The size may vary to suit the fancy of the designer or it may be governed by the particular belt it is to serve. The

BUCKLES
CLASPS
AND
BAR
PINS

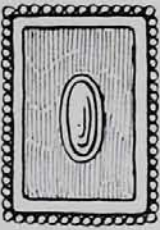
A.



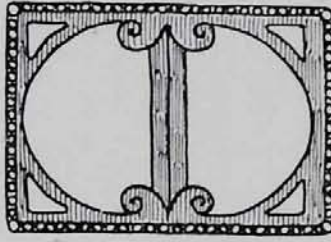
B.



C.



D.



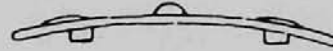
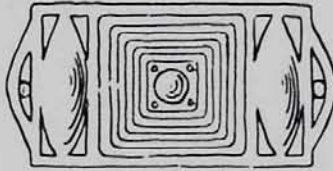
E.



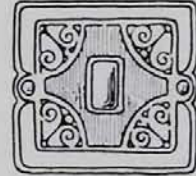
F.



G.



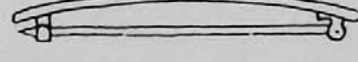
H.



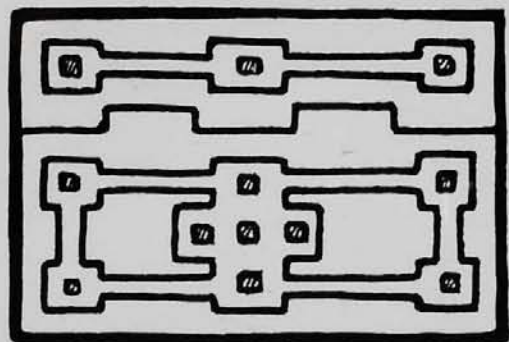
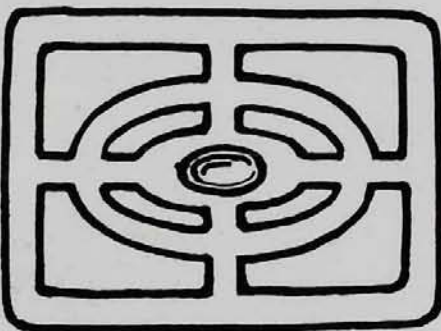
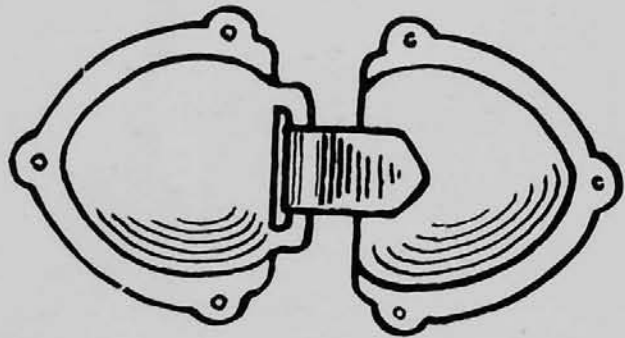
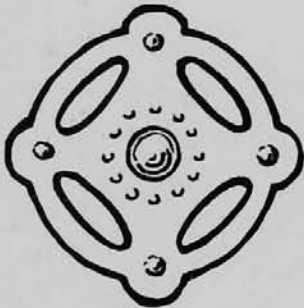
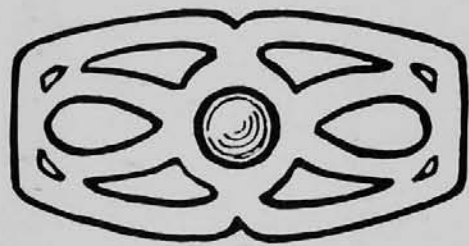
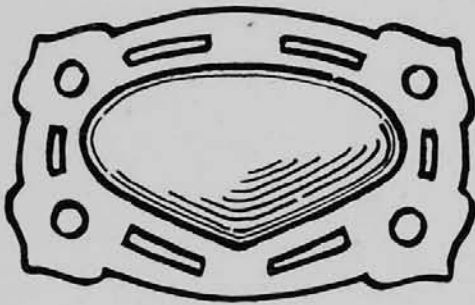
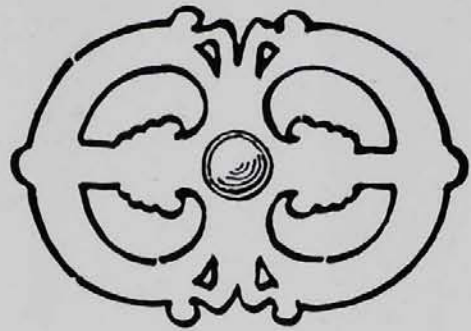
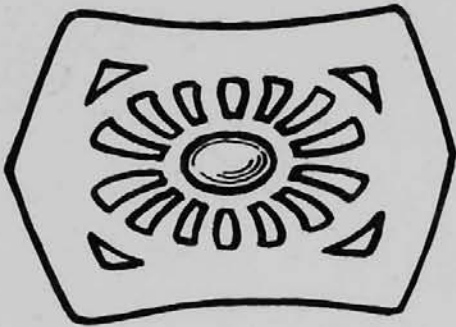
I.

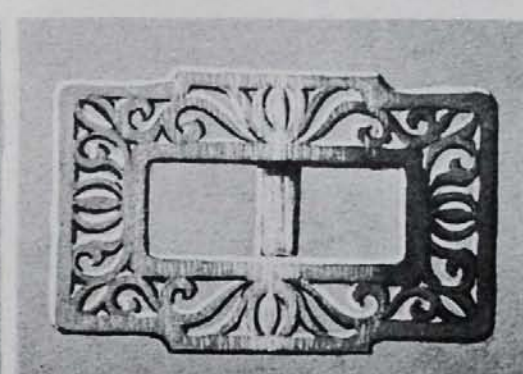
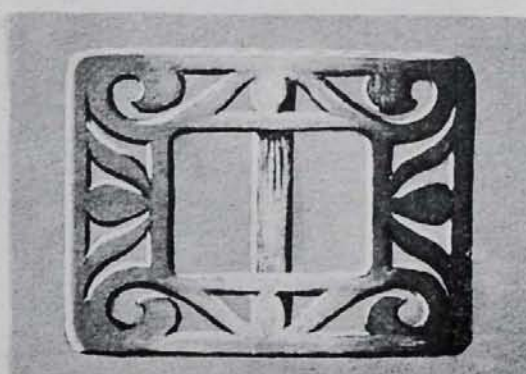
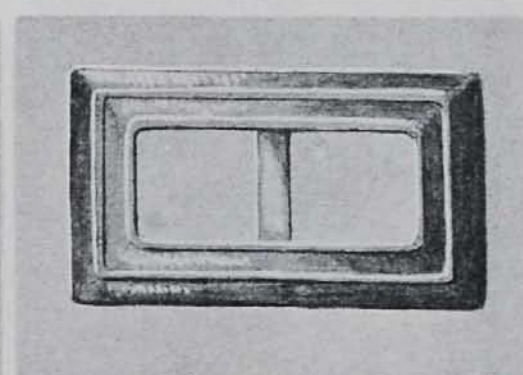
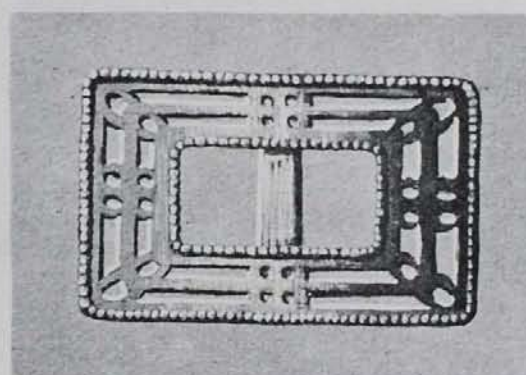
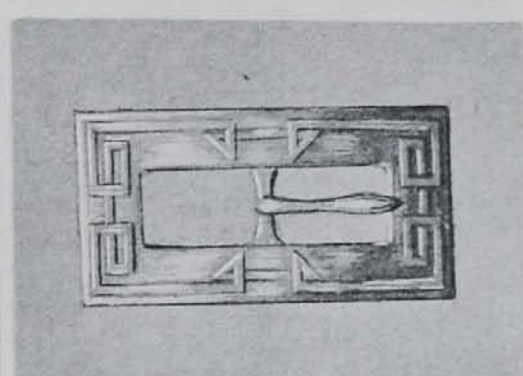
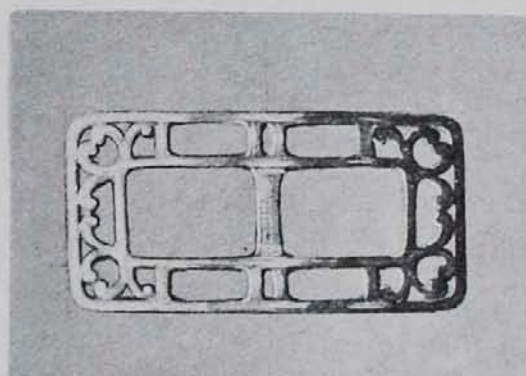
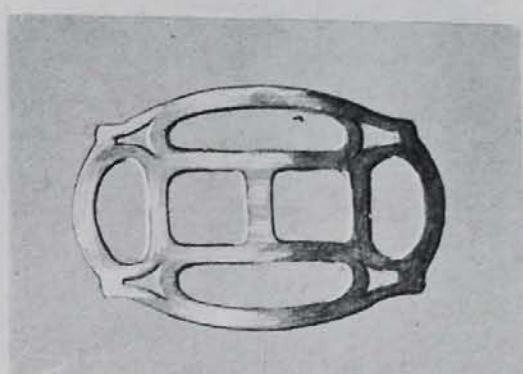
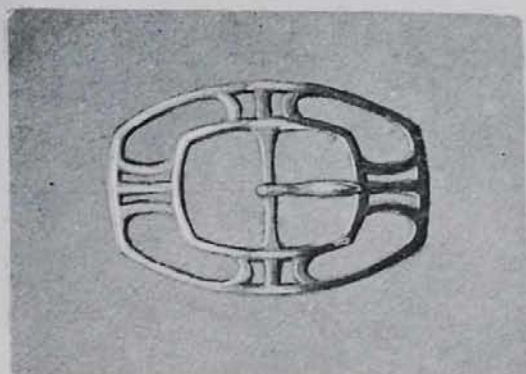


J.



DESIGNS FOR BUCKLES





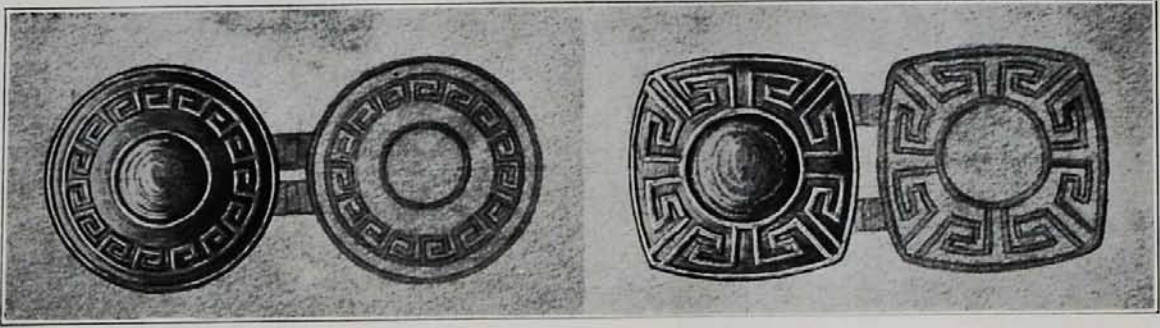


FIGURE 205

contour should be a simple rectangle, square or oval, or a slight modification of these, the surface may be enriched by an etched, chased, enameled, pierced, or applique design, keeping it always in low relief. A large cabochon stone, as Figs. E and F in Plate CXXII, with a small border design around it or even fancy wire, make pleasing and serviceable designs. The catch and the clasp of this problem are placed on the back. Such parts should be concealed, whenever it is possible to do so and should not project very much above the surface of the buckle, as the latter in turn will protrude too much from the belt. With the foregoing facts embracing the limitations and possibilities of the article, the design confines itself to a small latitude, which, instead of being a hindrance to the designer, as might seem at first, is indeed a help to the solution.

The bar pin is much the same as the brooch and buckle both in design and construction, the only difference is in its length and width. The bar pin being used horizontally has a dominant horizontal axis hence the outline and whatever ornament used should emphasize this effect. Fig. I, Plate CXXII, consisting of three rectangular stones with beaded wire around them and about the edge of the pin, carries out the idea above mentioned. Fig. J, however, at first glance seems to contradict the principle governing the bar pin. The units possess a dominant vertical axis, but these units are so short and so simple in their effect that the long horizontal effect of the pin itself is not disturbed.



Pendant, Lavalliere and Necklace

THE pendant is an ornament that is suspended from the neck by a chain.

Its size varies to suit the wearer and it is invariably worn over the garment. Another form of pendant smaller and more delicate in character, is now in vogue, namely the lavalliere. This is worn, almost without exception, with a low neck dress and is often set with a small brilliant. It is sometimes worn about the throat. Whatever the distinction, they are both types of pendants and are governed by the same principles of design.

The pendant may be arbitrary in its size and set with one or more stones of varying dimensions. The idea of a pendant must be set forth in a conspicuous way as the dominant characteristic in the design. This is done by emphasizing the vertical axis. The ornament used in conjunction with the stone, whether applied, carved, pierced, or enameled, should be consistent with the qualities that the stone or stones possess. A common shape for a pendant or lavalliere is pear or oval. The widest part may be above or below the center of the horizontal axis as examples shown by Figs. A and H on Plate CXXVI. Other contours used are the elliptical, rectangular, diamond shaped, and circular. Whatever the shape the stone or stones should form the center of interest and should, therefore, assume a conspicuous position on the pendant. When one stone is used, it is often more interesting to place it a little above or below the central point of the pendant. The



FIGURE 206

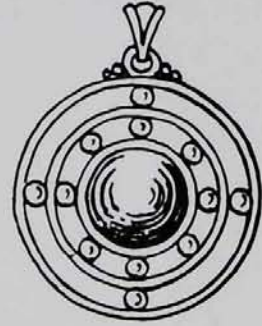
STRUCTURAL ELEMENTS IN PENDANTS



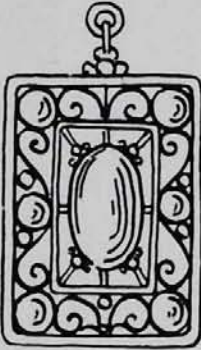
A



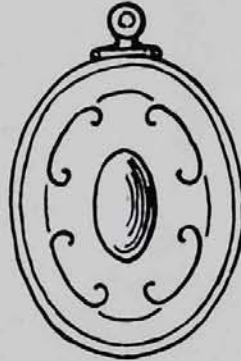
B



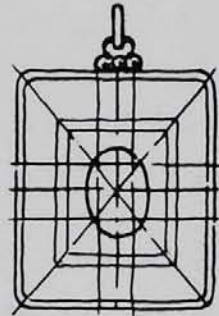
C



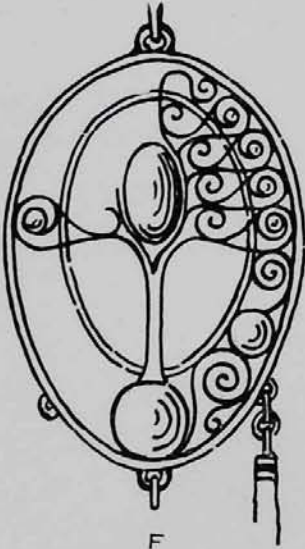
D



G



E



F



H

examples of pendants just mentioned represent typical outlines used and the structural elements upon which ornament may be constructed.

Fig. A, shows the use of the curve of force, radiating from a common point on the upper side of the stone to form the contour of the pendant and terminating into scrolls on the inside and on the outside of the oval shape. The smaller scrolls at the bottom of the pendant grow out of the larger ones, making a fine terminal for another stone or drop. All the lines of this pendant seem to echo the shape of the stone with pronounced rhythm and perfect unison. The scrolls must vary in size and grow out of each other in order to secure interest and variety. The scrolls must describe such curves as possess fineness of proportion and unity of movement. In each design there should be some dominant scroll pronouncing a definite movement. Fig. B displays the same rhythmic lines about a common center of interest. The lines here generate upward from the bottom of the stone and make their way into the pendant area, echoing the shape of the stone. The movement is in harmony not only with

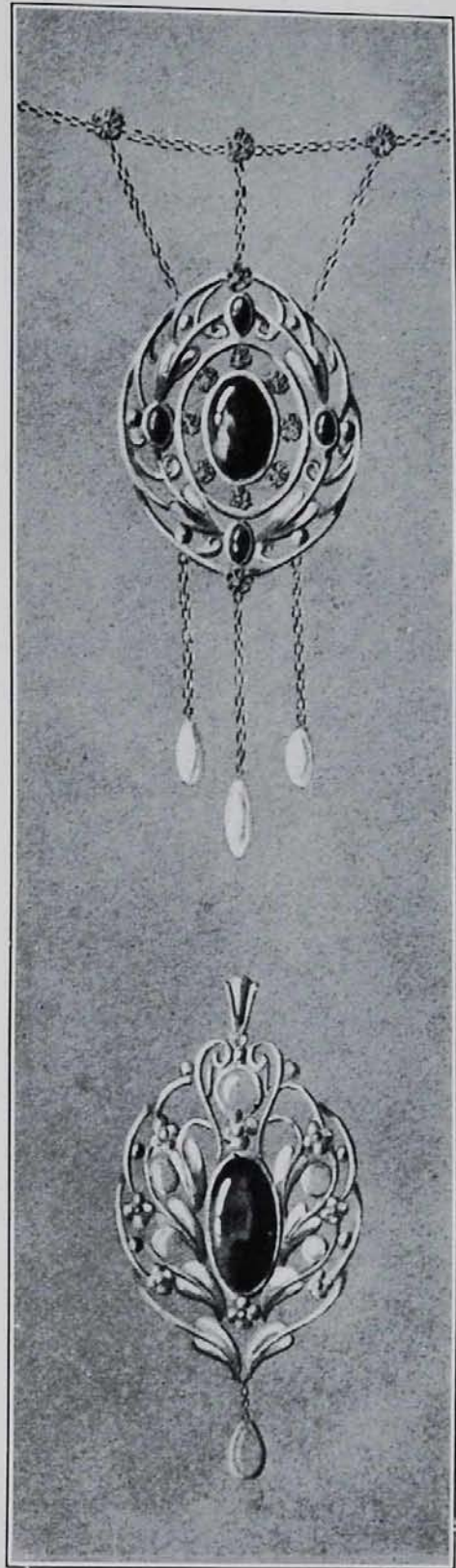


FIGURE 207

PENDANT DESIGNS



the stone but also with the contour of the pendant itself. The dominating structural lines of the pendant lead the eye gracefully to the slide and eventually to the chain. When possible the chain should appear to grow gracefully and tangentially out of the pendant, and never abruptly or at right angles to the main curves of the pendant. The interest of this pendant has been intensified by allowing the structural lines to terminate in leaves and flower. The interest of the stone has not been sacrificed by the addition of these forms since some of the leaves carry their interest to it, while those above the stone deliberately move toward the chain, thereby equalizing the interest. The drop in this pendant has taken the form of a bell-shaped flower, conforming to the naturalistic effect of the whole design.

Fig. C is a pendant showing a large stone. Because of the size and color which this stone possesses it is deliberately intended to make these qualities the dominating features of the design. For this reason very little ornament is ascribed to it, in order to allow the stone to make the appeal in the interest of the pendant. Nothing could be more simple than plain bands of circular wire interrupted at various places with silver shot to relieve the simplicity.

Fig. D illustrates the way in which it is possible to adapt elliptical and circular stones to a rectangular contour. The corners have been rounded to soften the angularity. The main structural lines here are concentric with the contour. The small circular stones find places in the corners and on the horizontal axis. This pendant needs no additional feature in the nature of a drop.

Fig. E represents another rectangular pendant with vertical, horizontal and diagonal lines ready to receive the ornament.

Fig. F has, besides the structural lines, one quarter of the design suggested. Interest has been added by making the ellipse on the same vertical axis but on



different centers. The two stones are placed in an unusual way relieving it from the formality that accompanies the ordinary position of stones in jewelry. The scrolls that form the decoration in this pendant grow out of the vertical axis. This construction is analogous to the structure of a tree, the elm especially. These scrolls repeat themselves till they meet at the vertical axis again. The area in the lower half of the two ellipses which form the frame of the pendant are filled with scrolls which have an upward movement. The round stone forms a strong point of attraction, but not enough to detract from the central feature. It serves to conceal the construction of the two scrolls which radiate right and left from underneath it. The area in the lower half of the small ellipse has been left blank to contrast with the parts that are filled with scrolls. It is not to be understood that all spaces must be completely filled to secure good space filling. The drops on the right, left and middle serve to break the monotony of the contours and also emphasize the pendant-like effect.

Fig. G represents an elliptical-shaped pendant with four scrolls on a concentric ellipse about a stone. The scrolls are merely starting motives of structure and whatever interest is added should resemble the first thought, if not harmonize with it.

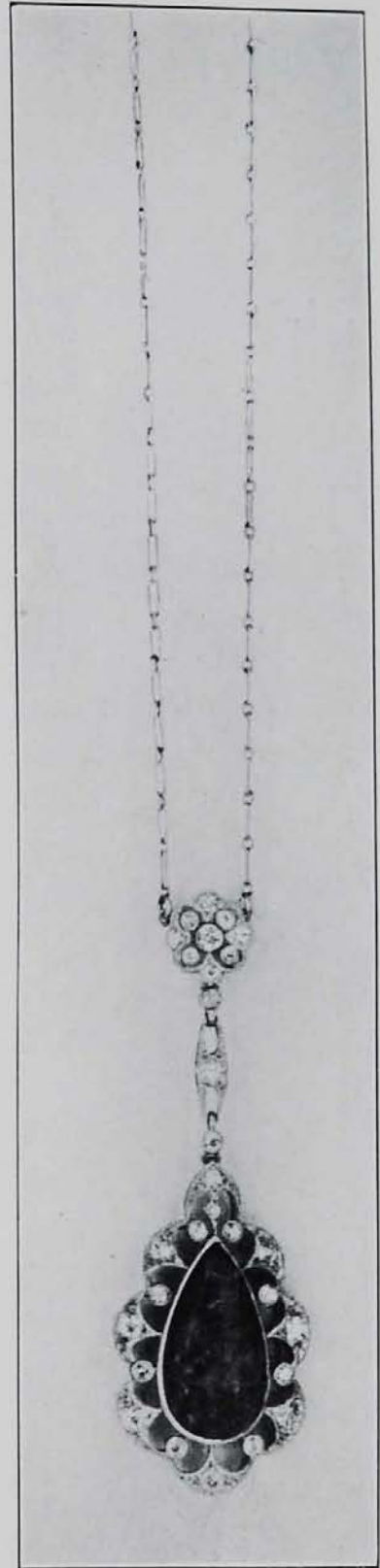


FIGURE 208

Fig. H is similar in contour to Fig. F but the oval in this case has been filled unsymmetrically. Although the scrolls radiate right and left into the oval area there is an occult balance that is pleasing to the eye. The stone is the center of interest but is not placed in the center of the pendant. It serves at this place as a point from which the scrolls may radiate. The small end of the pendant below the stone is made more interesting by working the metal into small ornamental units thereby relieving the stone from an otherwise heavy appearance acquired by its location. The method of distributing the ornament is less conventional than those previously described but much more interesting.

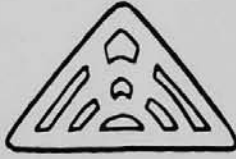
Plate CXXVII shows pendant designs using square and rectangular shape stones. The straight line effect of these designs is in keeping with the angular effect of the gems.



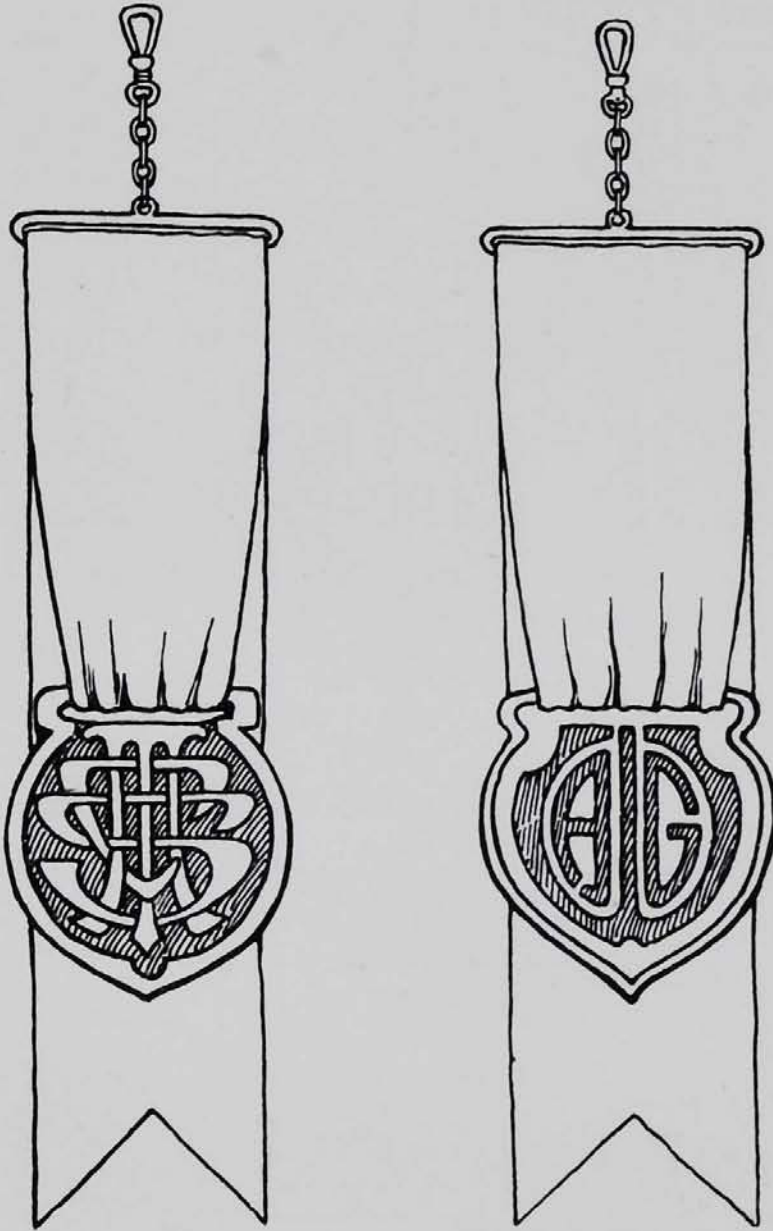
The Watch Fob

STRICTLY speaking a fob is a small pocket attached to the waist or belt. The word has been extended in meaning and made to include the appendage that hangs from the pocket and connects the watch, hence the so-called watch fob. The watch fob takes the place of a watch chain. Ordinarily a plain ribbon one inch to one and one-quarter inches wide suffices. In order that the ribbon may keep its shape, some form of weight is attached to it. This device is designed to suit the aesthetic idea of the owner and has assumed an important place in the jewelry industry of today. The ribbon has often given way to metal parts connected by links or by hinges, which makes it more durable and allows more opportunity for aesthetic expression, as Plate CXXXI. The watch fob is of comparatively recent origin. For all intents and purposes a plain flat piece of metal attached to a ribbon with enough ornament to keep it within the realm of good taste is sufficient to fulfill the requirements of a watch fob, as Plate CXXX. The seal-type fob, Fig. 106, adds to the practicability because of its size, it being easier to take hold of than the flat one. However, if the flat type is desired, it is possible to use a large, deep cabochon stone, mounted on a piece of metal about the width of the ribbon, thereby securing the necessary weight. On this type the ornament must be used sparingly and simply, especially if the stone takes up most of the area. Fancy wire, such as the twisted, braided or beaded, makes a very good border effect around stones when very little ornament is to be used. The pendant-

DESIGNS FOR SEAL FOB

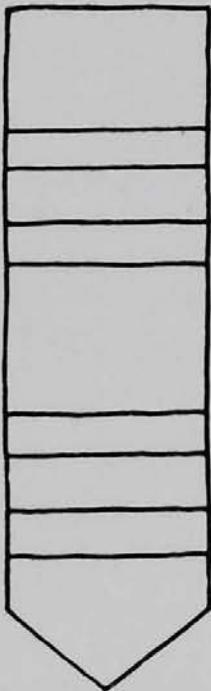


FOBS IN ENAMEL

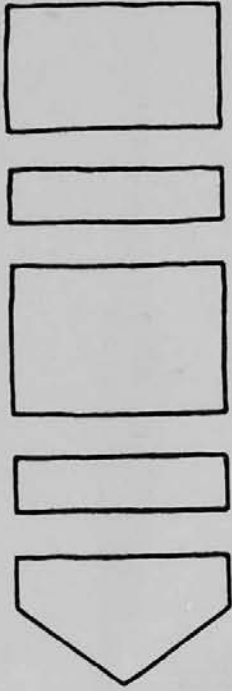


FOB IN ENAMEL

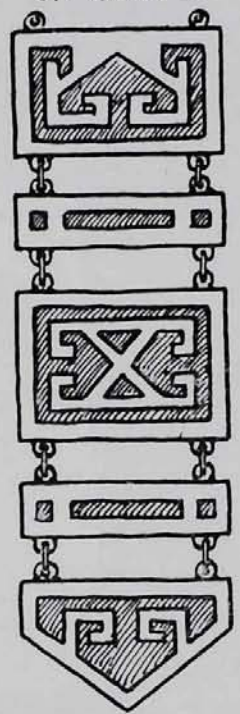
DIVISION
OF MASS



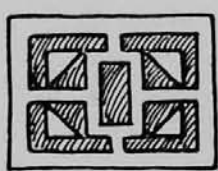
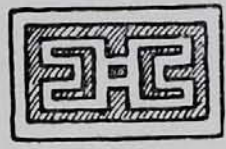
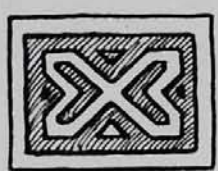
PROPORTION
OF UNITS



ORNAMENTATION
OF UNITS



SUGGESTIONS FOR UNITS



shaped fob, swinging by a loop or ring, is a good one and preferred to the square, oval or elliptical. Whatever shape is used, the fob must be free from rough edges that cause wear on the clothing. The triangular shape, which is a modification of the pendant hanging as described in Chapter XLIV, can be brought within the limits of the above restrictions and made to serve the purpose excellently. These contours admit very little modification if the outlines are to conform to the requirements previously stated. The base of the fob is designed with curved sides to do away with the angular corners, while the sides are domed to conform to the outline of the base. The triangular-shaped area may be enriched with any of the technical processes employed in the jewelry craft. The designs illustrated on Plate CXXIX are pierced. The elements here are abstract in meaning, although natural motives might have been used with equal results. The designs present diverse ideas in practically the same outline. Whether taken from natural form or geometric figures they may suggest movement, leading up to the loop or movement radiating to each of the three corners, or may be purely static.

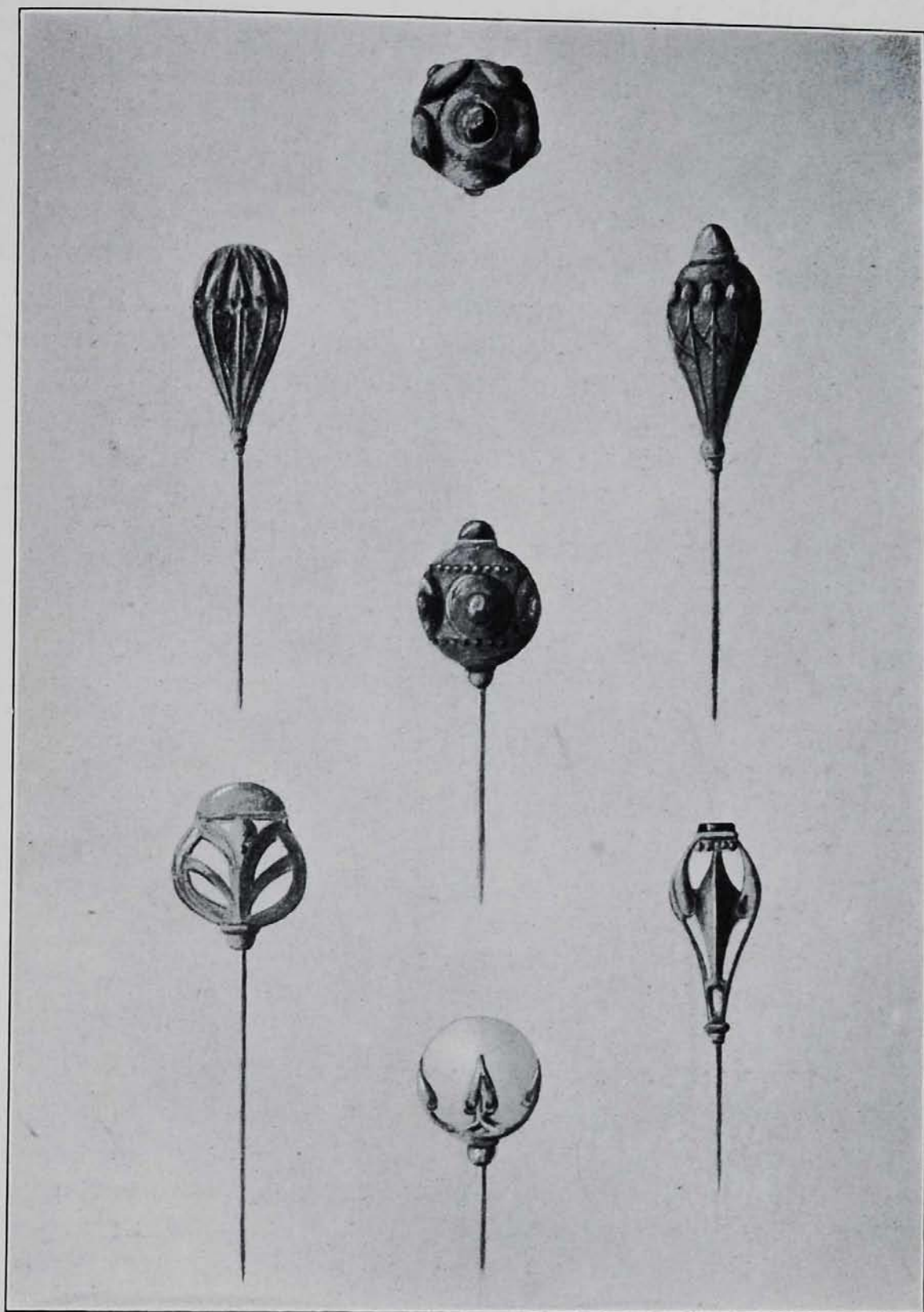
The Seal Fobs, Fig. 106, suggest the relative proportion of seal to length and width of ribbon, and also the amount of chain needed. Fig. A, Plate XL, represents different views, illustrating how the base is made to conform to the sides. Plate CXXXI shows the Ribbon Fob designed in metal, with the same rectangular spaces and variants, while the spacings at the left on the same plate, illustrate the steps taken in working out pleasing relations of the different parts. The ornamentation on this fob is produced by enameling the design with harmonious color. Plate CXXX represents fobs in enamel with monograms as the motives.

Chapter XLVI
The Hat Pin

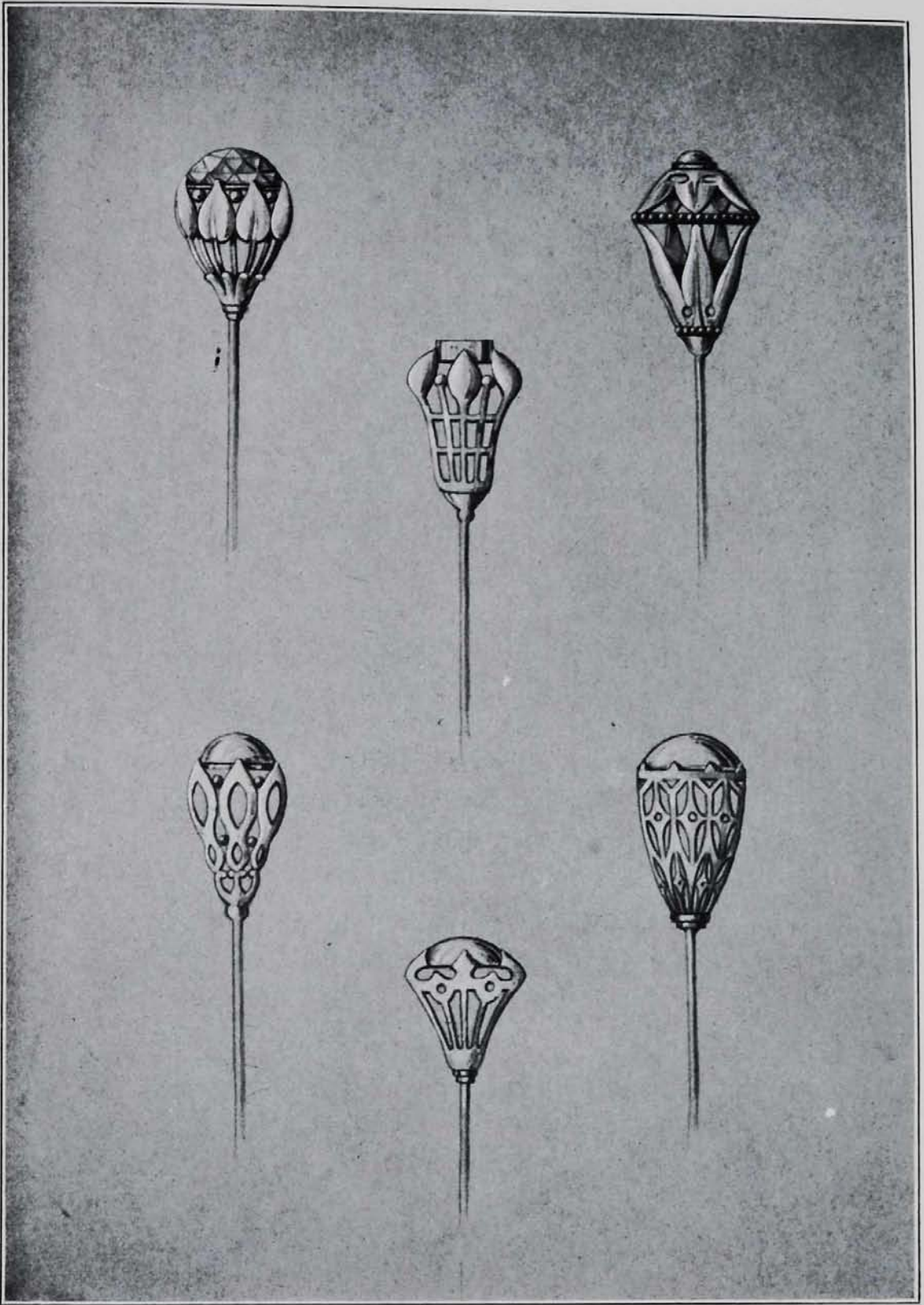
THE function of the hat pin determines its design and construction. As this article of ornament is a fastening which comes in contact with veils and other material of like nature it must be made free from objectionable projections or points. The length of a hat pin stem is governed by the size of hat in vogue. In designing it, the thought must be kept in mind that it is to be inserted with the hand. The size of the head should not be so large as to look conspicuous when on the hat and not so small as to render it difficult to insert. With the requirements and limitations thus stated, the most practical shapes for the head seem to be such forms as the sphere, hemisphere, cone and their modifications. The surface enrichment of these may be either pierced, embossed or built up of many parts. Nature forms such as buds with perhaps the calyx turned down suggest many good ideas for hat pin designs. The natural stem with the bud or open petals on one end needs little interpretation in terms of metal and stone to make a suitable hat pin. The upward growth of leaves, or spreading petals of a flower, are ideas that lend themselves to this problem as to no other. In Plate CIV we have a naturalistic drawing of the hollyhock. The sepals surrounding the bud form have been used to serve as a setting to hold a stone. As this setting would look too plain and barren, if used bodily, it becomes necessary to introduce some opening in a



FIGURE 209



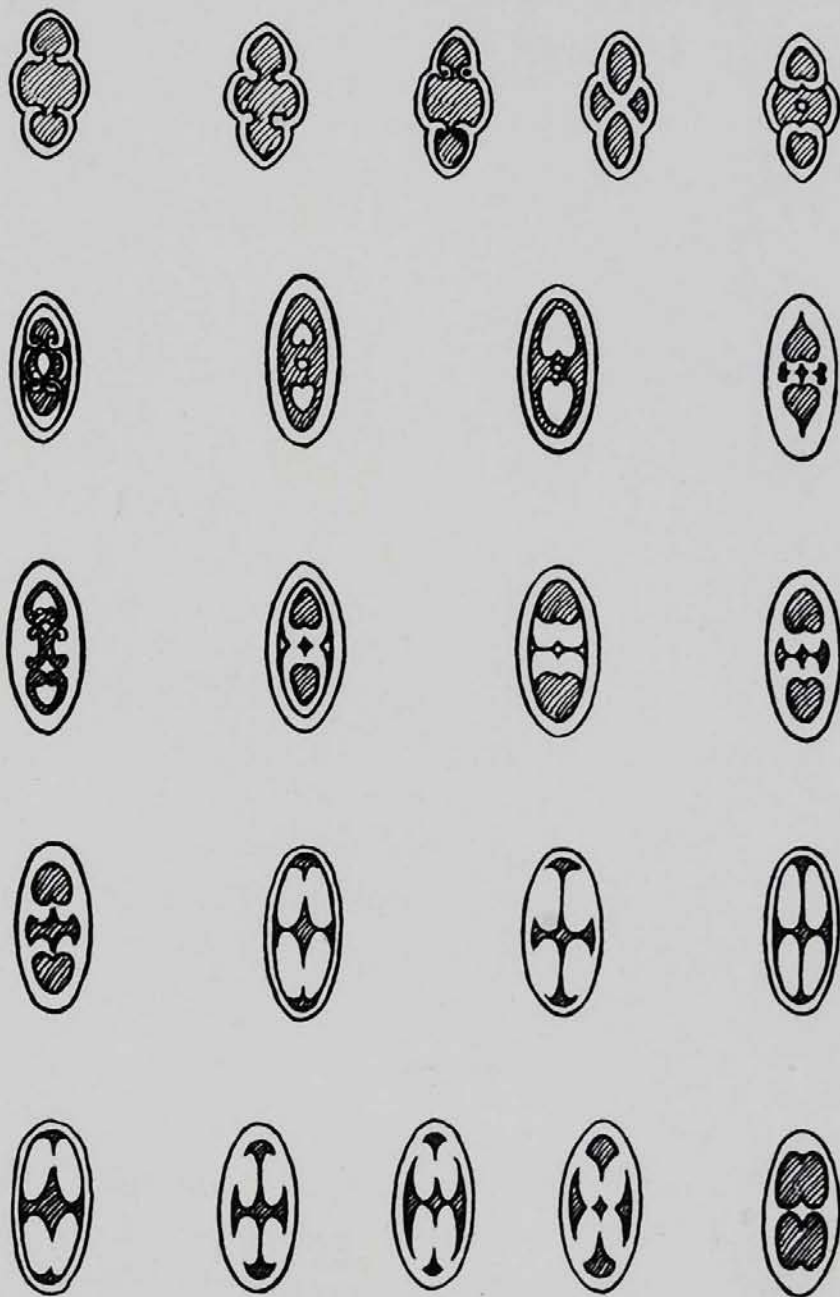
definite and orderly way. The result is a border design around the form, adding interest in dark and light and at the same time producing a more delicate effect, from the standpoint of design. Some of the designs on Plate CXXXIII show how leaves and stems have been repeated in a border-like manner about a stone. The border, however, must not be so large in spots as to weaken the metal. The practical side of the problem must be constantly kept in mind. In designing, the designer should have some knowledge as to how it may be made. The torus part of the bud has been made to serve a practical as well as an aesthetic purpose, this form not only strengthens the union of the two but also helps to fill the angle made by a straight line of the stem and the contour of the head. Hence the head appears as though it grew out of the stem as in the natural form. The approach from the stem to the head should be gradual and graceful, the curves of the contour spreading out till they reach the widest part of the head. The motives used in the designs of the above mentioned plates are arranged in a border and form a part of the stone they embrace. The openings are not too large nor too small to interfere with the practicability of the hat pin. The relation between openings and metal is carefully considered and worked out till the proper adjustment is secured. The openings tend to emphasize the pattern made by the metal. The leaves of some of the design have been slightly modelled to relieve the otherwise flat effect. The design is expressed in clear and concise terms because the proportion of metal and openings is in harmonious relation. The relation of the height of the head to its widest part was worked out when the contours were sketched roughly for consideration. When this relation was found, motives from nature or abstract ideas were made to take place with the hat pin and the stone to be used.



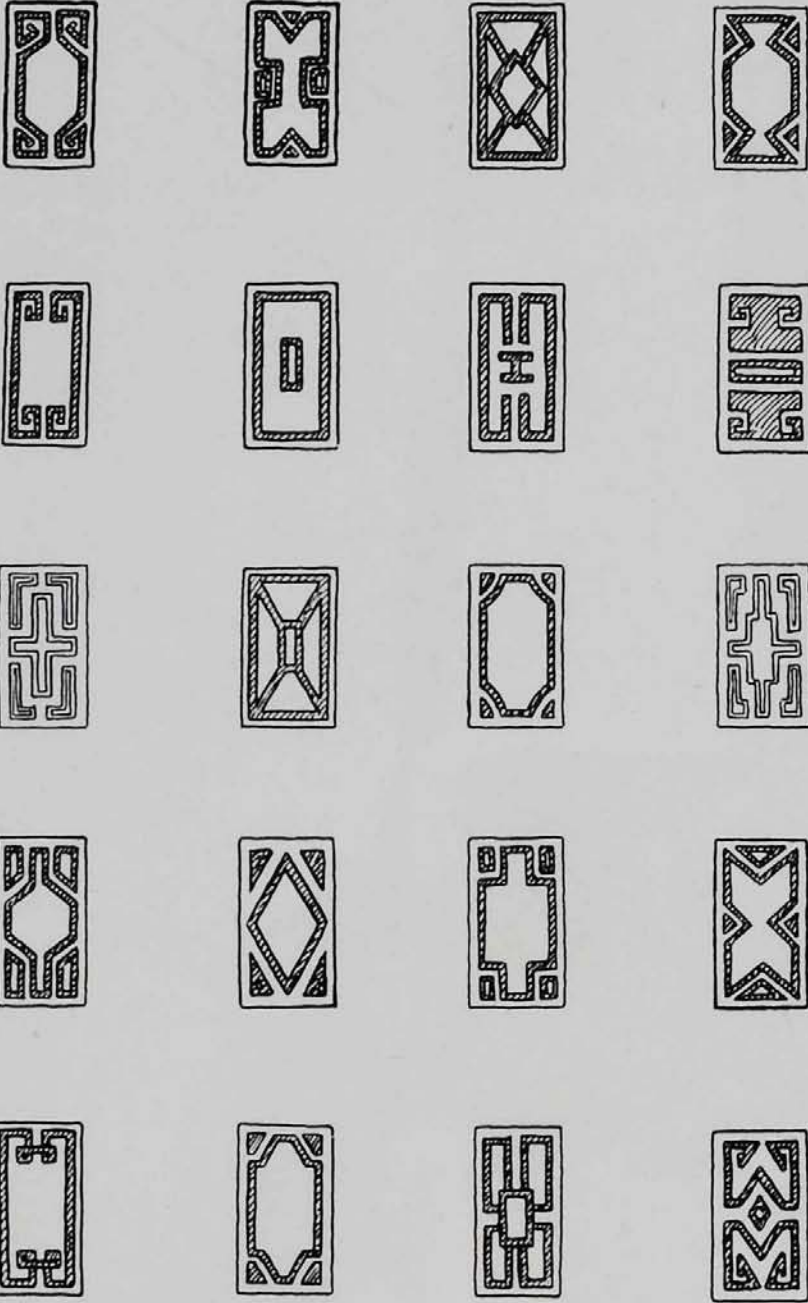
The Cuff Link and Cuff Button

AS was mentioned in the chapter on the principles of jewelry design, the cuff button or cuff link is one of the pieces of jewelry that may be called useful. It serves to keep the ends of the cuffs together. Cuff links may be made on the principle of a link with a loose disc on either end. Sometimes a button is duplicated on either end of a stem but it often has a bean at one end. The stem is curved in order that the cuff may come together when the button is in place. The use to which the cuff link is put determines the nature of its ornament and its contour. In order that it may be serviceable, it must be easy to insert into the cuff. This demands that the shape be of a convenient size and the ornament in low relief. If the button is used with a bean, it may be spherical or lentil shaped. The button may be made any shape so long as its outline remains unbroken. The shapes preferable for this purpose are rectangular, circular and elliptical. The elliptical designs on Plates CXXXIV and CXXXVI are variations of the same idea. The designs herewith illustrated are curves which harmonize with the outline of the button. The design may be executed in a number of different ways; it may be etched, chased, or enameled. Those illustrated are designed for enamel as this is an attractive medium for artistic expression. The rectangular shaped designs on Plate CXXXV are also for cuff links or cuff buttons. This problem is simply the breaking up of a rectangular space. Whatever the problem, the technical process of execution should be foremost in the designer's mind, since in many ways

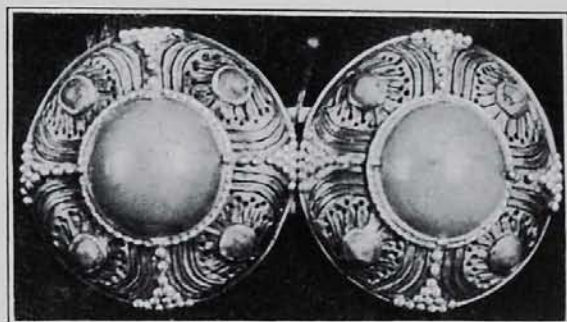
CUFF LINKS FOR ENAMEL



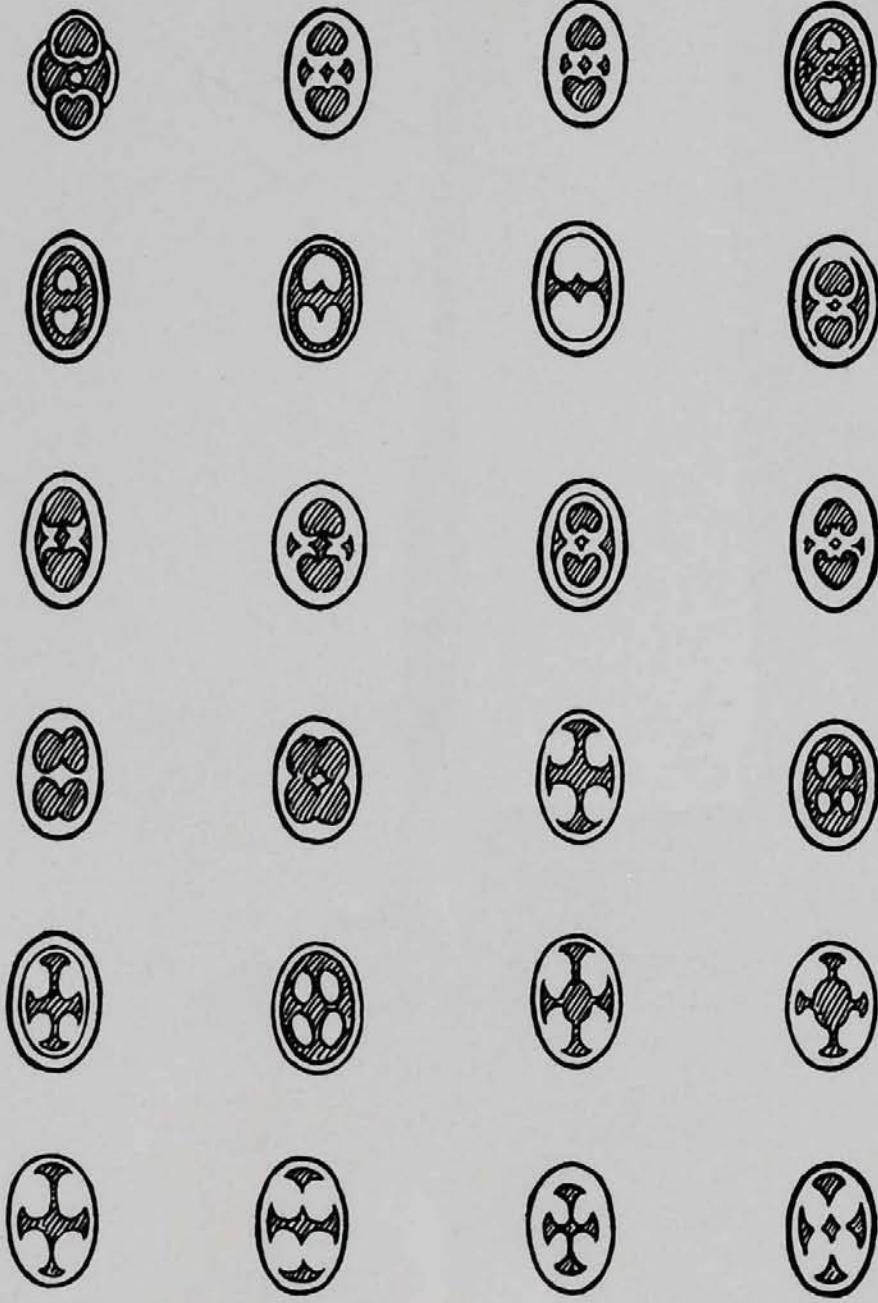
CUFF LINKS FOR ENAMEL



it determines the nature and the structure of the design. It will be noted by the surface decoration in some of these designs that the patterns are impossible for pierced work, but may do very well for other technical processes. These illustrated are best adapted to enamel and are designed to be executed in that medium. The design is thought of in terms of channels that are to be cut out of the metal to receive the enamel. These channels may be of various widths but the pattern is determined by the outline of the button. The simplest design would be a repetition concentric with the outline. A modification of this may be made by the addition of another small concentric spot, again repeating the shape of the outline. Further developments of the first idea may be made by modifying the outline to a slight degree.



CUFF LINKS FOR ENAMEL



Chapter XLVIII

The Finger Ring

AS a personal ornament the ring is the most common form of jewelry. The design is limited in shape and area. All rings have a point of attraction either in the stone or in the ornamentation, the wedding ring alone being an exception. The ring form is a device to display a stone which in turn adorns the finger. This fact makes the stone the main point of interest in this form of jewelry. Some of the Egyptian and Roman rings, consisting of plain bands of metal set with roughly cut stones with extremely little if any ornament, illustrate this point. As in all forms of design the ring must comply with the principle of fitness to purpose. The part of the ring that is on the inside of the finger must be narrow enough to cause no discomfort to the wearer while the top of the ring may be light or heavy as desired. The lines forming the sides of the shank should be simple curves although they may be slightly modified. When ornament is used it should be kept subordinate to the stone and all other interest added as decoration should lead the attention from the shank up to the stone in a graceful manner with increasing interest. The stone should be the center of interest while the decoration on the shank and around the stone should echo its characteristic features. If the stone is light and delicate in color the design of the ring and the decoration should be in harmony with these qualities. The stone forms part and parcel of the metal band and should be thought of as such in the process of designing. The method of setting it whether by prongs, gypsy, belcher, or in a

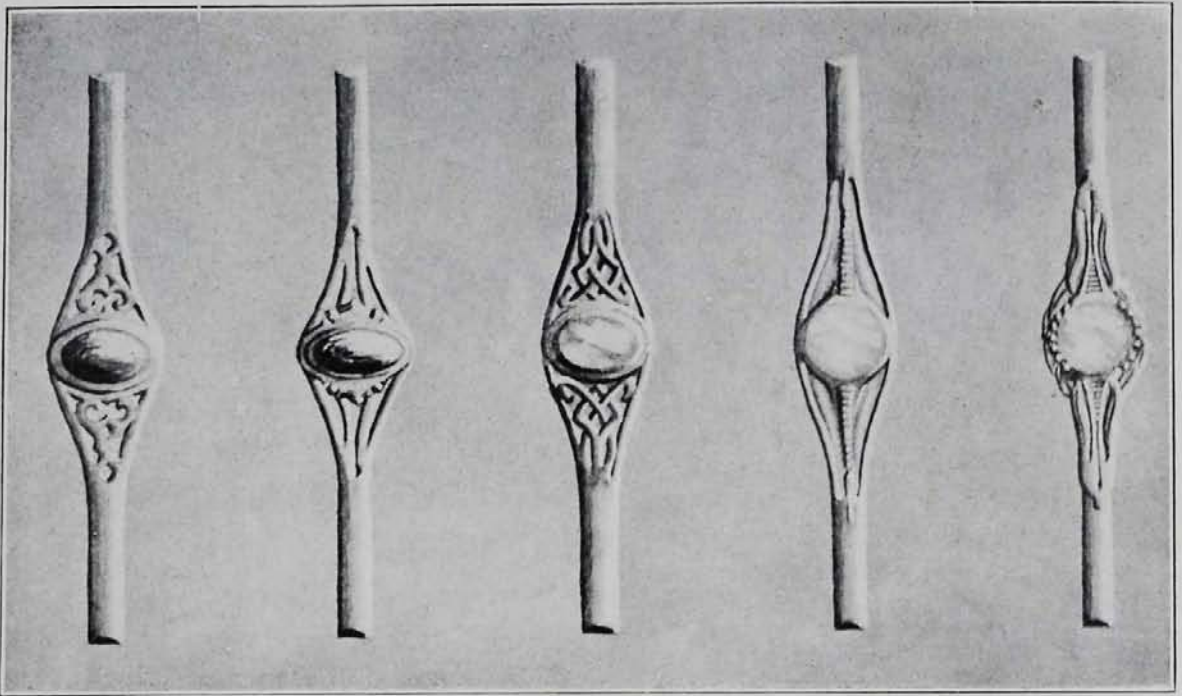


FIGURE 210

box setting is determined by the nature and cut of the stone. A small stone of brilliant color can be made important if set in prongs while soft stones may be set down into the metal in a gypsy setting, to protect the stone. Large and high stones should be set in this way in order that the gem and the ring may have unity of effect.

Plate XXXIII-A represents designs that can be executed by the amateur craftsman. The simplest modification of the plain band would be two or more saw-piercings on the shank, increasing in width as they approach the stone. Variations of these piercings should keep the vertical effect of the ring. Although Fig. 210 represents designs for cast, chased, or dye work the same principles of design are involved as in the pierced ring. These are more appealing since they represent those fine subtle qualities of modeling in basso rilievo which are necessarily absent in the pierced ring. We have in these designs an attempt to extol the qualities of the stone. The decoration is



restrained and simple, neither overdone nor detracting from the interest of the gem.

The platinum ring presents a charm that is all its own. The color, hardness and rarity of platinum have restricted the workman in its use in a most judicious manner. Hence instead of the synthetic method of building on the ornament, or by carving, it is preferable from the economic standpoint to make the design apparent by perforation. The very fine saw-piercings impart the effect of delicate wire work. When designing for a platinum ring as those illustrated on Plate CXXXVII it should be considered much the same as fine wire work. The designs are to be governed by the same principles as those previously explained.

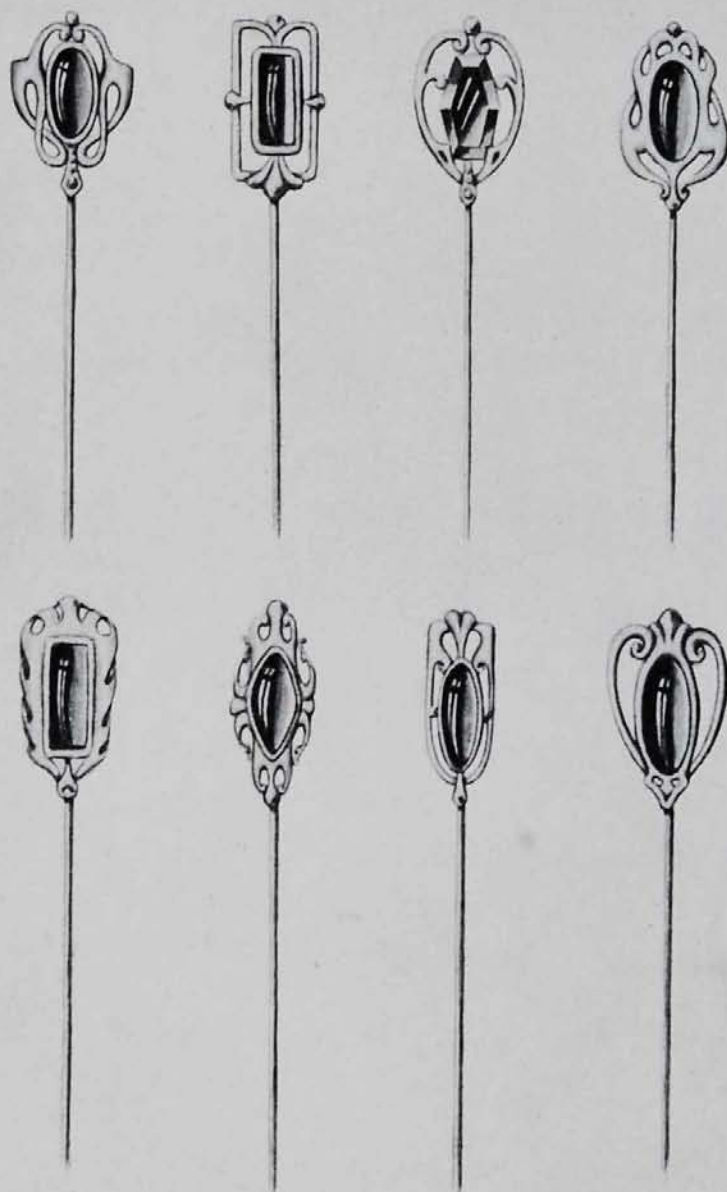


Chapter XLIX
The Scarf Pin

THIS is an ornament that has a practical as well as an aesthetic value. It serves to hold the necktie together, hence its practical value. It calls attention to the necktie, therefore its artistic effect. As in all problems, the scarf pin is governed by its use. Like the hat pin it must be free from points or prongs or any projections that are apt to interfere with its use. It should also emphasize the vertical axis. The design, in most cases, is determined by the shape of the stone, and, in all cases, the contour must be kept severely simple. The amount of ornament that the scarf pin may have depends upon the size of the stone. The pin as a whole must not be large enough to detract attention from the necktie. Having determined the size of the stone, the next step is to make a shape around the stone that will be in keeping with it and at the same time limit the size of the scarf-pin. This should be repeated a half dozen or more times with stones of various sizes and shapes. The areas around the stone are then ready for the ornament which may be placed around in border like manner or with simple units at the intersections of the contour, with the vertical and horizontal diameter. The first attempts should be extremely simple, progressing in complexity as the designs increase in number. It was suggested in previous problems that if the stone is to occupy most of the area, a beaded, or braided wire around the edge is very effective, especially when the stone is opaque or heavy



FIGURE
211



in appearance. Such simple designs as a plain wire concentric with the stone, connected to the bezel with granulations at equal distances, may be made to express fine relation between primary and subordinate masses in the same degree as the most complex problem in art. After the wire and granulations have been used, fancy wire either round, square, or rectangular may be considered as scrolls, either two or more in number, clustered about the stone and connected at the points of contact with silver granulations. Very fine filigree work made up in scrolls presents unique ideas for stones of delicate colors, especially the faceted ones. The number of ideas made with the scrolls, leaves, and granulations is unlimited. This problem is analogous to the brooch, except that its size makes it more difficult to design and to execute. Scarf-pins, designed with enameled borders of color, that accentuate the stone or harmonize with its color produce excellent effects. Extremely fine pierced work, having the effect of wire about a stone, and an enameled line around the rim of the metal, produces a fascinating design. The designs on Plate CXXXVIII represent domed surfaces with rounding parts. The contours are varied about as much as the pin will allow on account of its use.



FIGURE 212

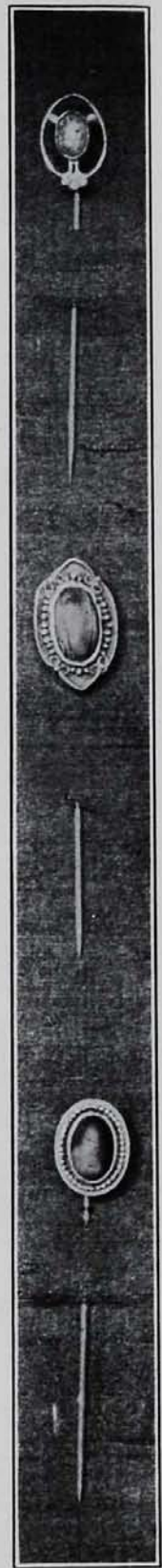


FIGURE 213

Chains, Pendant Slides and Pendant Connections

A CHAIN is a common device for suspending pendants, watches, lorgnettes, fans, muffs and various other articles. It should be designed strong enough to insure strength throughout its entire length. This condition being complied with, the chain may be made to assume interest by modification of some of its many links or by the intervention of a bead, stone, or an enameled unit. A chain of plain links cannot possibly stimulate any interest, but if a link of a different character is used at some regular interval, the monotony is relieved somewhat and the chain becomes more pleasing since it arrests the eye at these various points. A few inches of chain alternating with a round pearl of a proportional size will add much interest to the chain. This interest can be increased by using more pearls, say in groups of three, or alternating three pearls with one pearl or with two pearls, etc. Many such combinations may be considered to add proper interest and variety. The pearls, however, must not be used to excess or the result will be vulgar rather than refined. Plate CXXXIX shows combinations of pearls, long rectangular

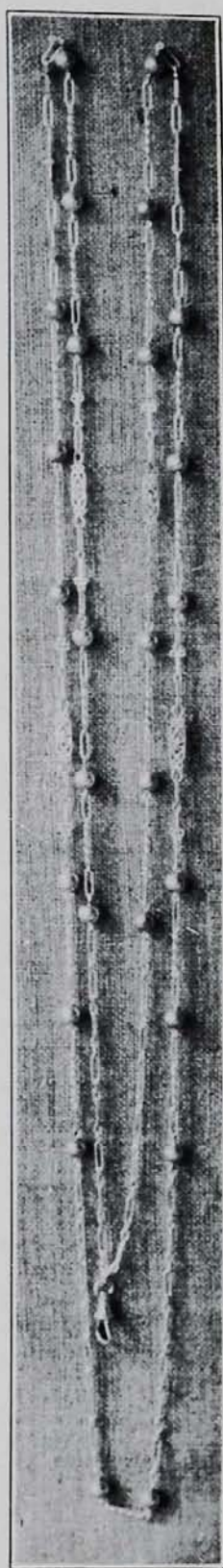
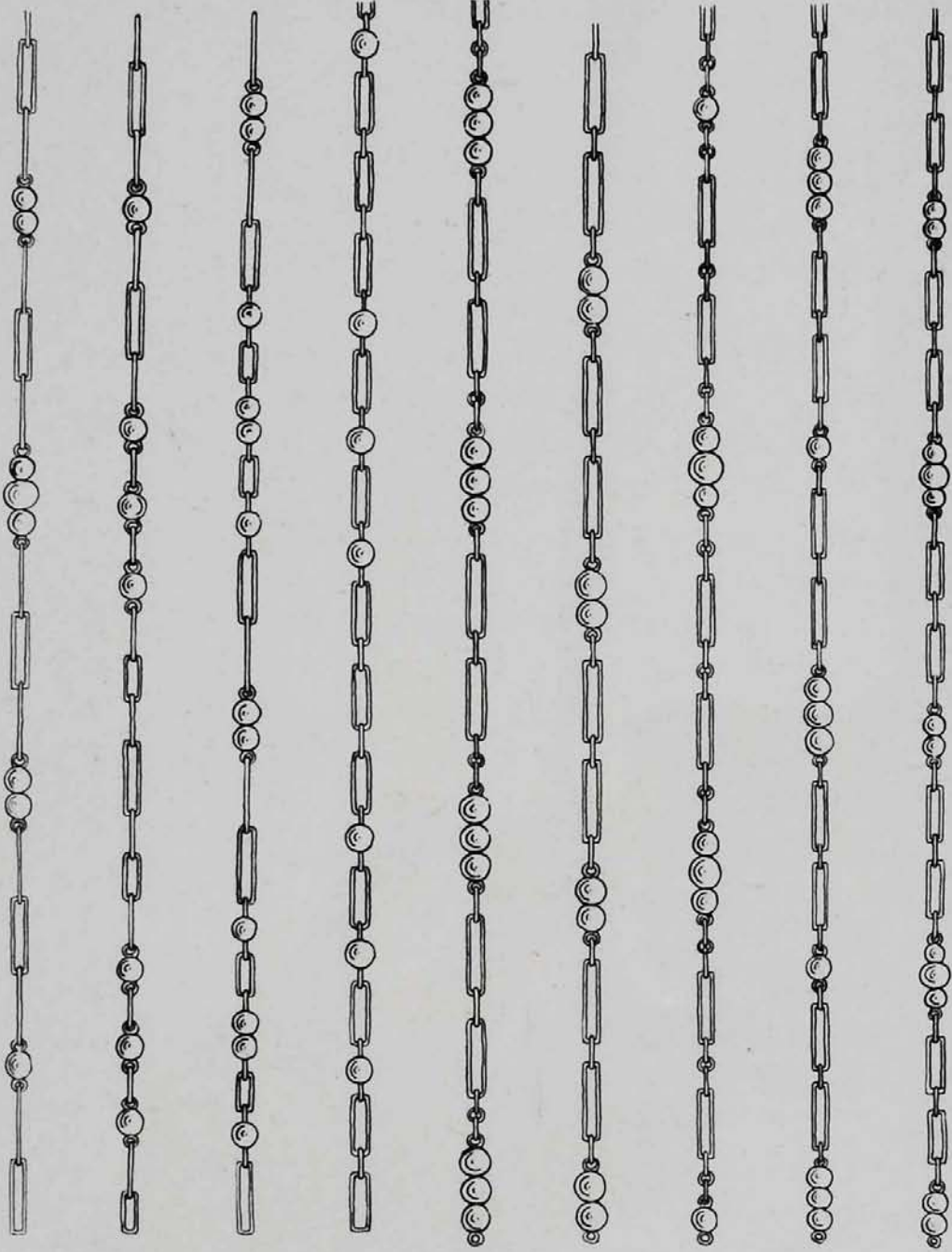
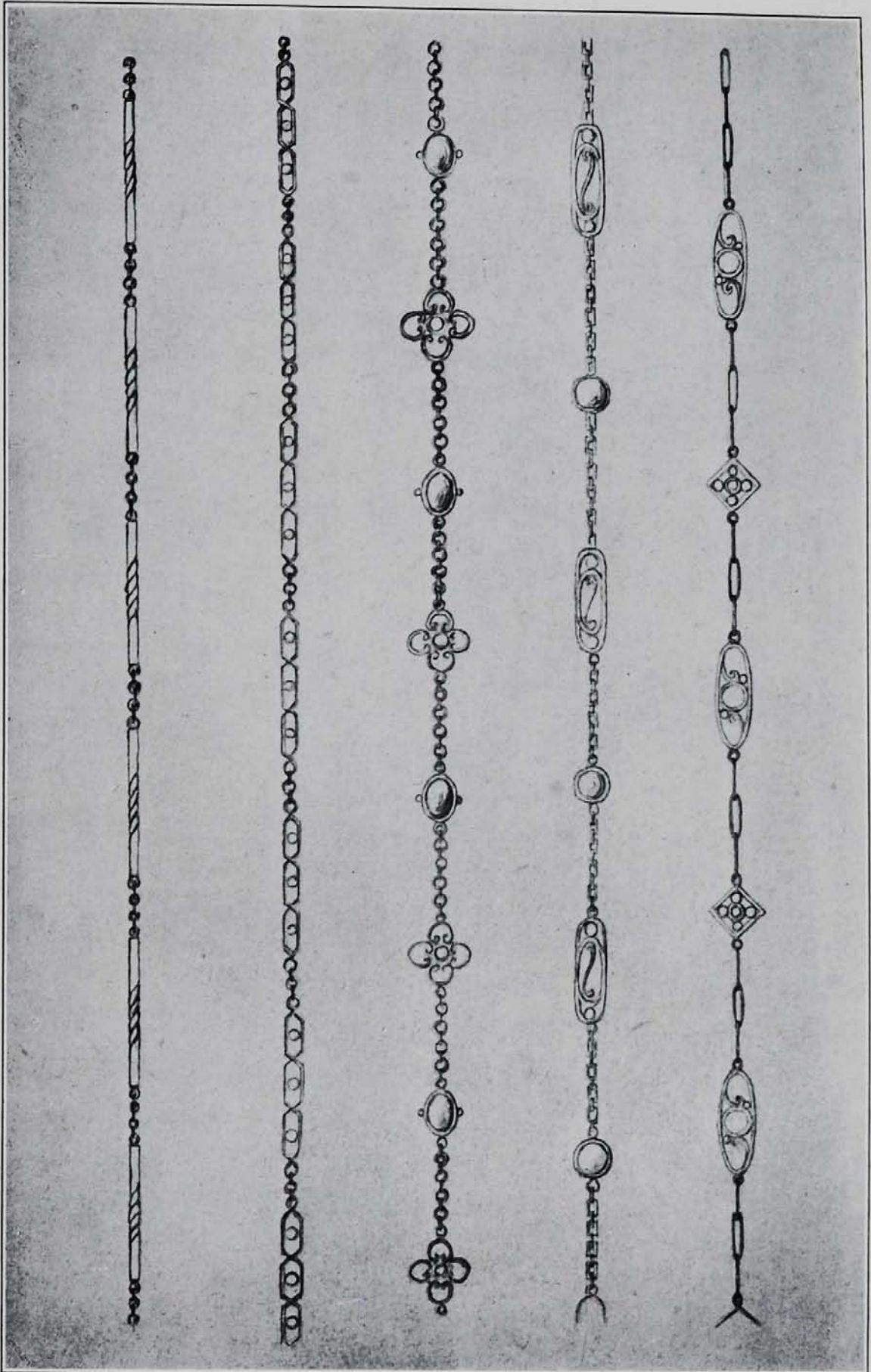


FIGURE 214

BEAD ARRANGEMENT
IN CHAINS



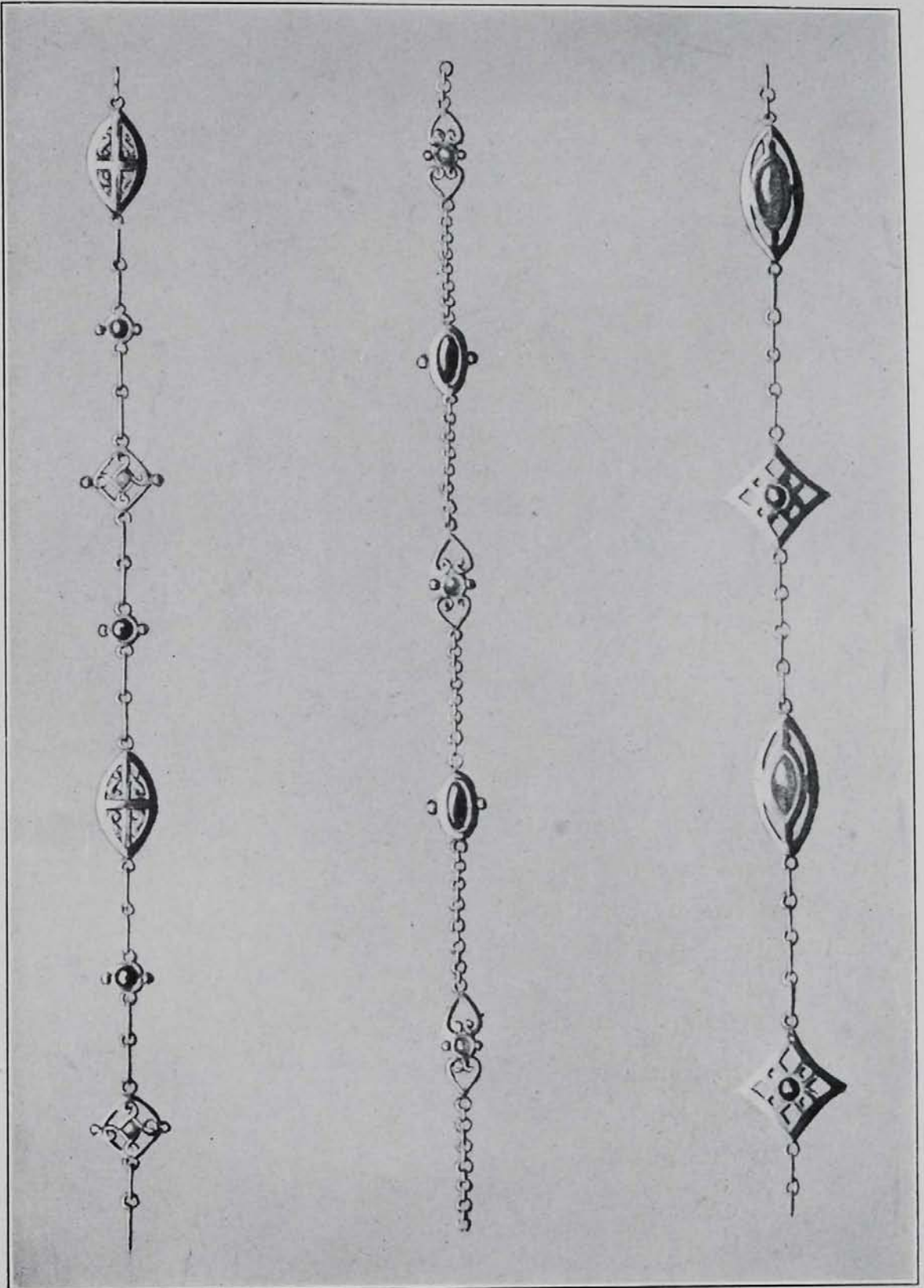


links, short rectangular links and round links, all used with a sense of discrimination that makes for fine relation between links and beads.

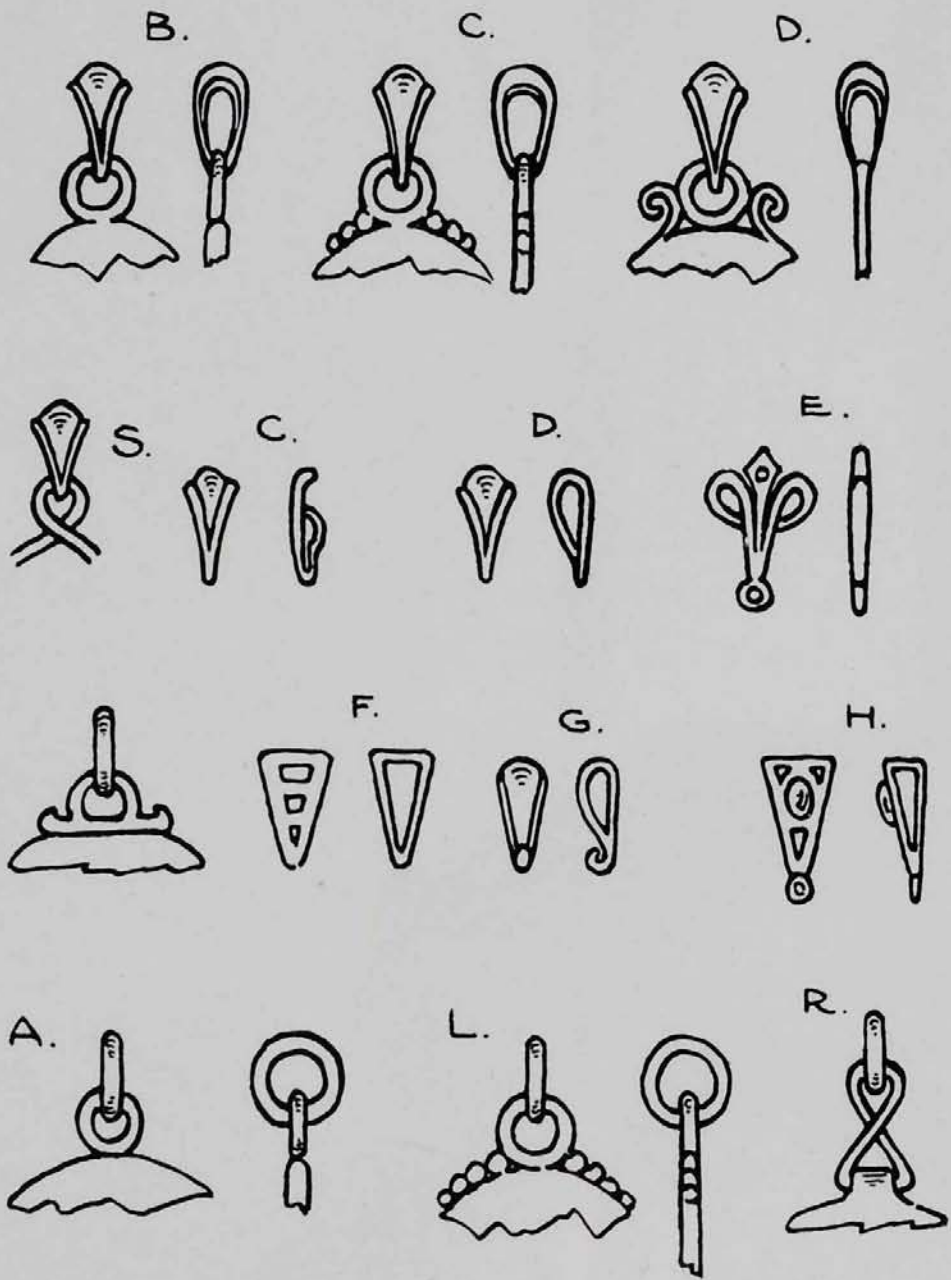
Plate CXL illustrates some good examples of simple but attractive chains. Bars of metal with a few twists in them, spaced at proportional distances and connected with very plain links, make good designs. Plain round or block links with bright colored stones at the proper intervals to alternate with some fancy links are exceedingly interesting. The fancy link placed between small plain round links may be rightly considered like the design for a small brooch. The more interesting this fancy link becomes, the less, of course, it should be repeated through the chain. The chains on Plate CXL have been designed for watches, fans, and lorgnettes, hence their delicate appearance.

Plate CXLI represents heavier designs. They are good examples to show just how far variety may be carried without endangering the interest it conveys. In the chain on the left it is noticed that there are three distinct units; although apparently different in design and size, they seem to bear the same relation in character, enough at least to make them duly related. The second chain is very simple, yet the eye is arrested by the difference in the large and small stones alternating at regular intervals. The large stones act as accents along the chain. The secret of success lies in this idea of obtaining chain units rightly spaced and imparting the right accent. This accent, accomplished in a fine degree, will set up a subtle feeling of rhythm that is very pleasing to the eye.

The simplest way, perhaps, of hanging a pendant may be done by the use of a ring as Fig. A, Plate CXLII, showing a front and end view, through which the chain may pass. A slide may be substituted for the ring as Fig. B which must be large enough to admit the chain to pass through freely in order that the pendant may assume a vertical position when worn. Figs. A, B, C, D, E,



PENDANT SLIDES

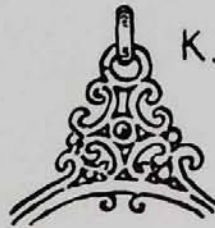
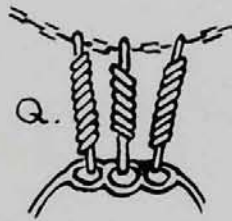
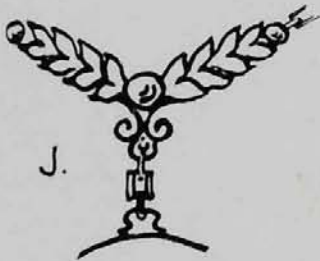
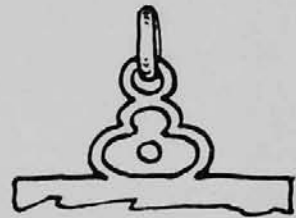
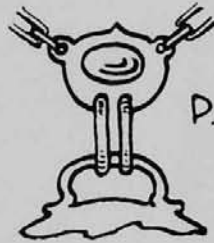
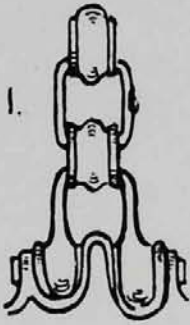
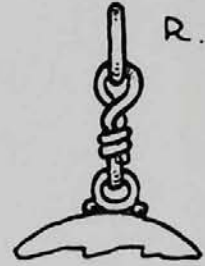
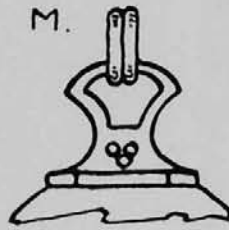


F, G and H showing front and side views, are modifications of the same style of slide, offering various treatment in design. This slide may be so affected by decoration as to become quite elaborate as Figs. I, J and K, Plate CXLIII. Oftentimes a small faceted or cabochon stone is set on the face of the slide when no other ornament is used as Figs. E and H, Plate CXLII. The slide may have a link soldered to it which in turn passes through a link of the pendant proper. The link of the pendant is often reinforced by granulations of decreasing sizes as they recede from the link around the pendant as Fig. L.

The three shot on the right and left respectively not only help to strengthen the union of the ring and pendant, but serve to simplify the contour.

In a heavy pendant the link may be replaced by a hinge fastening as Fig. M, Plate CXLIII. Although this may seem less decorative than the former ones it has more durable quality than the more ornate kind. Fig. I is another device for suspending large pendants. The rings are modified so as to assume a more decorative effect and their connection with each other is on the same principle as the hinge, although it is less conspicuous. Figs. J, K, N, and O represent very artistic ways of solving this problem. In Fig. J the slide has assumed the shape of a "V" fastening on the right and left of a stone which serves as a center of attraction. The leaves carry out the direction of the chain pull, by having it coincide with the lines of the chain. The main part of the pendant may be attached by a small chain or simply by a good size double link as Fig. P. Fig. Q is perhaps a rustic method of connecting the chain with the pendant. It consists of three wires made into a loop connecting the pendant and chain, each twisted about itself several times. This twisted link is shown in a simpler type by Fig. R. The twist not only adds to the decorative effect by breaking up what would otherwise be a long and mo-

PENDANT CONNECTIONS



notonous line but also helps to strengthen the connecting wire. Oftentimes when the soldering of links is not possible this method serves as an excellent substitute and the twist relieves it from the severe simplicity. The twist in a loop at the top of a wire pendant may be modified by this twisted effect as Figs. S and R. This lends much of the charm that is characteristic of hand-wrought jewelry. Whatever method is used to unite the chain and pendant, it should be in harmony with the character of the whole design.

The clasp or catch of the pendant may be a very simple device, made up of a bar and a ring, or it may be made in two hooks. Either of these is secure and easily constructed. The complexity of such a device may depend upon the mechanical ingenuity of the designer. However intricately made, its mechanical parts should be so treated as to become decorative features. The decoration which may be introduced to conceal the mechanical construction, should not lessen its serviceability as a catch. However the catch is devised, the fact that it must be made both secure and easy to manipulate should be kept in mind, also that it must harmonize with the design of the pendant.

The ring snap is a commercial product that offers good service as a means of unifying the chain. As it has been used for a long time, its merits are to be gauged by its favorable acceptance as a connecting link for pendant chains.



Keeping Freshness in One's Work

DESIGN is always the expression of a thought, a feeling, or an emotion, of a personality. Jewelry design is no exception. Design for jewelry is to realize an idea in terms of metal and stones. The thought may be to display some beautiful gem with a metal that may be so treated as to accentuate the qualities of the stone and to harmonize with the characteristics of the wearer. The success of such an attempt depends largely upon the ability to see these gem stones in their proper relation to the person; in a word, the designer must not only know the laws of beauty which make for artistic expression but also personal characteristics, that the two may be happily combined. Unless the designer, then, is a wide awake student of life itself the expression of his thoughts will become monotonous, meaningless, and dead expressions. As life changes it becomes necessary therefore to make designing a changing conception of these relationships. The process becomes one of continual change and adaptation to life. In making these adaptations the designer must look to nature for inspiration and use her boundless resources in new ways. If jewelry is considered as an expression of individual taste, and as necessary to happiness, it becomes a live subject stimulated by a human desire. These creations must be as different in their manifestations as personalities are in their varieties. In order to assure that the design may vary for each stone and for each individual the student must forever regard each problem as peculiar to the conditions at

hand. Nature with its inexhaustible supply of motives may serve to keep the designs different and at the same time fresh and full of living qualities. The student must seek not only new motives for expression but also new ways of interpreting these motives for the ideas. New structural arrangements must be invented, informal ways of arranging the stones and new ways of disseminating the interest of the motives must be tried at the expense of time and labor. Instead of the usual conventional method of distributing motives, instead of the obvious ways of securing balance, the student should endeavor to strike out new avenues of approach. The ingenious designer is constantly inventing new ways and means of obtaining the desired result. Instead, for instance, of beginning with the boundaries of the design and working toward the stone, the center of interest, the process may be changed, working in zones from the center out to the confines of the design. Above all, the designs must be done with ease and freedom if they are to look crisp and vivacious. Designs must be a direct result of a thought and whatever changes or corrections are desired should be carried out in a new drawing. The results should look free, easy and appear spontaneously expressed. If this method is adhered to the designing will never become tiring nor will the designs look labored or strained.



Chapter LII

The Note Book

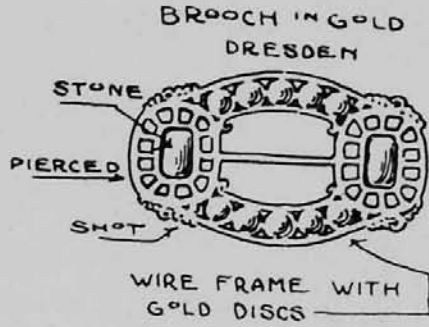
MANY times the art student who is open minded sees things in nature that inspire him to action; at other times, as he sits by himself dreaming of things beautiful, fleeting ideas come to him that may be startling. These moments which are filled with thrilling beauty and that excite the artistic impulse should be recorded else they be gone never to return. It is this idea, this inspiration, that comes to us while our mind is unconsciously at play with the artistic Muse that later proves to be the incentive to a work of art. The ideas which are but imaginary in the beginning should be given visible interpretation. At these particular moments the notebook is invaluable. There are many beautiful motives around us that may be helpful in our work, but unless they are recorded and thought of they will mean little or nothing, and we shall possess only a meagre storehouse of ideas. This is one of the ways that the student can gain an abundance of material as an asset in designing. The notebook ought to be the student's constant companion since he may have occasion to use it at every waking hour. Sometimes it may be the little wild flower in the field, or the line of the creeping vine, or perhaps, the beautiful shape of the alderberry; and, may be the beautiful pattern made by the shadow of the big tree by our house is worth making note of. But let us not stop here; if we look toward the open sky it may be the shapes of the little clouds as they appear over the horizon in rhythmic procession; then the beautiful

MUSEUM SKETCHES

BROOCH
SILVER



PIERCED SETTING



BROOCH IN GOLD
DRESDEN



FLAT STOCK AT BACK

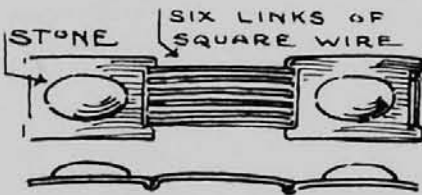
BROOCH
DRESDEN MUSEUM
GOLD WIRE
STONE IN
CENTER



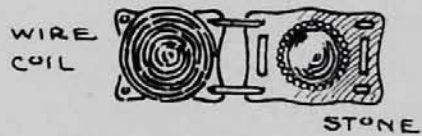
BIRMINGHAM
PIN
GOLD WIRE



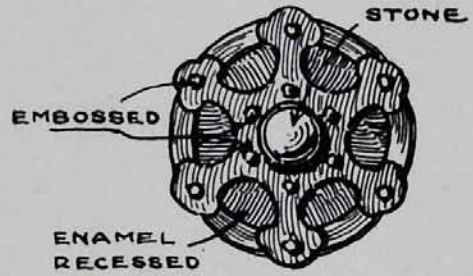
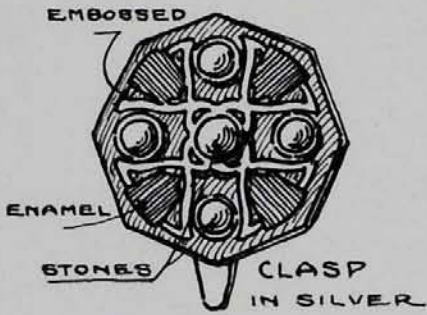
BRACELET



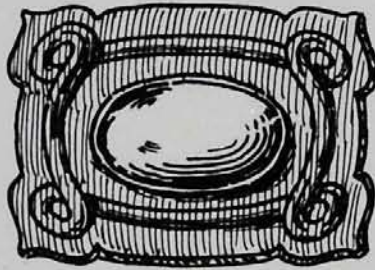
UNITS OF BRACELET



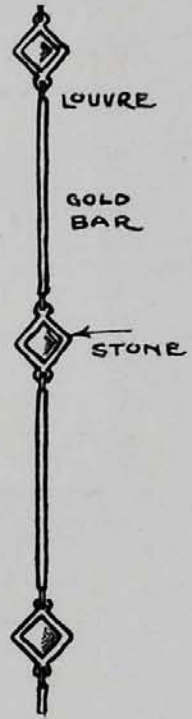
MUSEUM SKETCHES



BELT BUCKLE
SOUTH KENSINGTON

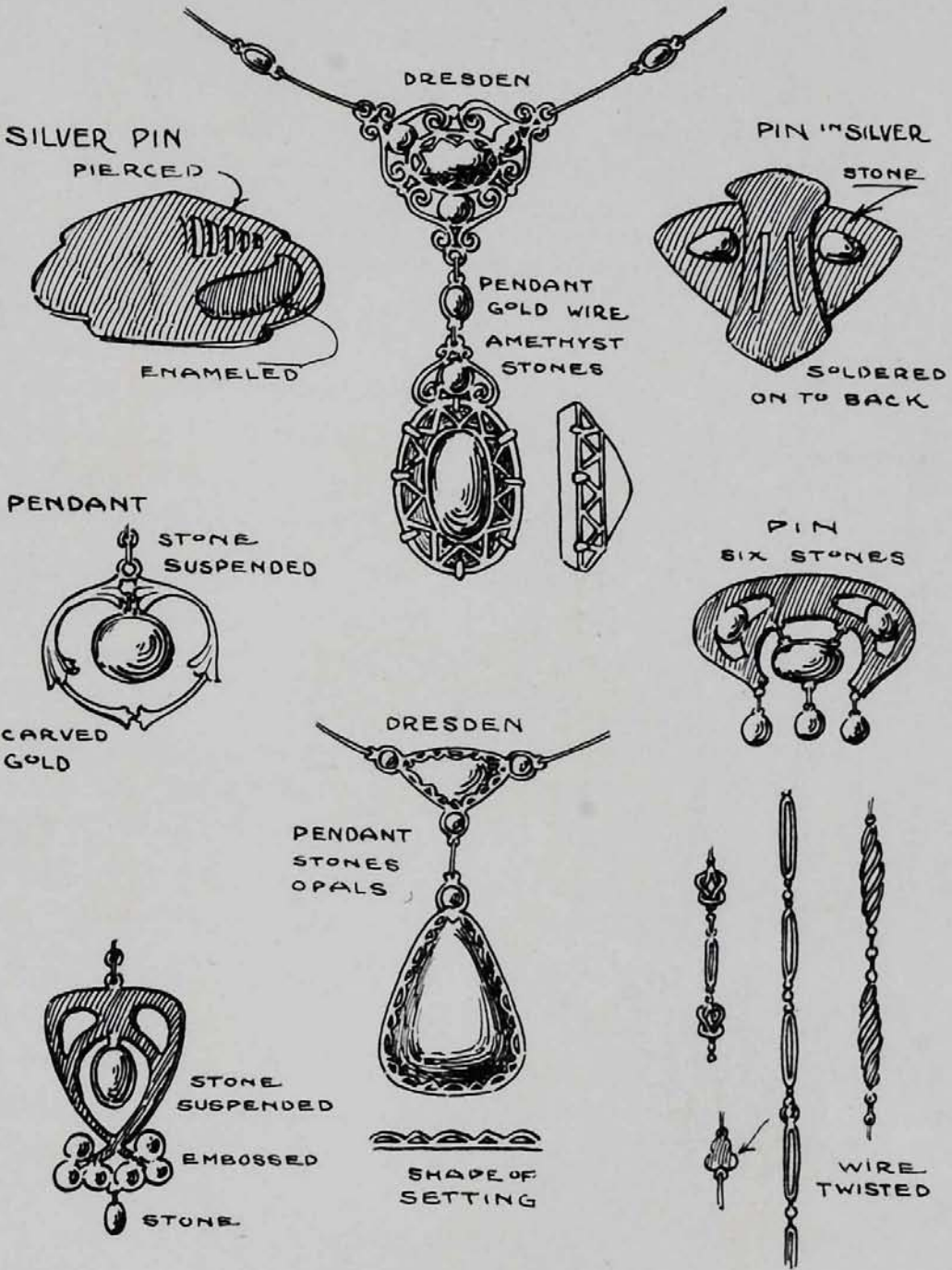


TWO VINES RUNNING
ABOUT ENAMELED CENTER.
MADE IN SILVER, OXIDIZED



BUTTONS IN COPPER
WIRE AND SHOT SOLDERED
TO BACK

MUSEUM SKETCHES



lines made by the smoke of the old farm house chimney is perhaps interesting with its long sweeping curves as it dies away. Then too, while our eyes are still in the heavens, we note the line made by the swallows as they are soaring side by side. There are so many things that might be mentioned if the space only permitted. The winter with its Jack Frost patterns on the window panes as we awake early in the morning may strike us with awe and wonder. The drooping icicles from the twigs of the lofty elm after a cold rain may suggest so much with its rhythmic curves, or sparkling glassy beads on the frozen buds may excite the student of jewelry design to practical ideas.

Then when going to the museum the notebook fulfills another great service and one which reminds us in later years of our visit to the Louvre of Paris, the British Museum in London, or the Metropolitan of New York. It will enable us to live again the joy we had in viewing the beautiful works of art, those which interested us most and arrested our attention to such a degree that we stopped to make a note here and there. Perhaps it was the wonderful hand-wrought jewelry of the Egyptian or of the Greek. All this we find in our precious notebook. The note may be no more than one quarter of a bilaterally symmetrical design as this is sufficient to recall the whole. Then with the aid of words and enlarged details as Plates CXLIV, CXLV, and CXLVI, the note means still more so that, should we feel at any time like making a replica, it would be quite possible to do so. The illustrations show the methods of recording notes of interesting bits of jewelry.



Equipment for Jewelry Drawing and Design

TO secure the best results in any kind of work, it is essential that good material be used. Poor tools in the hands of a novice are certainly not conducive to good work. This applies so much to jewelry designing that, from the very beginning, the best material is recommended.

Drawing materials such as papers, pencils, brushes, and colors, are so numerous that no attempt will be made to discuss all the varieties but simply suggest those that have been found, from experience, to give excellent satisfaction.

For the beginner for jewelry drawing a 10" x 14" pad of ordinary drawing paper does well. The advantages of such a pad are economy and the manner in which the paper is put up. The sheets will always be flat, free from cracks and wrinkles, which is very desirable for good results. As the work becomes smaller and more erasing is necessary, a paper with a better surface should be used, especially for color work and pencil shading. The ordinary drawing paper has not enough body for this work and if erased very much the surface becomes rough.

Pencil shading requires a paper that has a smooth surface and more body than common drawing paper. The smooth surface is very desirable for fine detail work. A Keuffel & Esser Normal Paper will give excellent results for pencil shading. A number seven Strathmore water color paper is generally used for the brush work although for large work a paper with more

texture takes the color much better. Colored papers are often desirable, especially when rendering in black and white. When a quick result is wanted a colored paper like the Granit Rendering Paper is excellent. The colored papers have the advantage of showing off the gold or silver colors much better and producing a more harmonious effect. The white papers are often tinted with a flat wash to obtain colors that will best harmonize with the design to be rendered when the colored paper is not suitable. Platinum work may be rendered on black paper or on celluloid. When using celluloid, that with a dull finish on one side is preferred since it holds the color better than the smooth finish. The advantage of using this material is that the design may be washed off and the celluloid used again.

Gray mounting board is sometimes preferred to the other papers because of its color and thickness. When a design is to be subjected to much handling a board of this weight preserves the design in an excellent manner. Although the surface does not permit any erasing it takes the color so well and the harmony produced is so satisfactory that the effort made to keep the drawing free from erasures is well worth while.

As tracing paper is used quite extensively in this work, a good grade will save time and trouble. A paper that is strong and transparent is recommended while the use of thin ones coated with a wax film is discouraged.

Blotters such as are used for commercial purposes render good service in soaking up color and in drying brushes. The colorless blotting paper is to be preferred because oftentimes the colored ones when wet stain white drawing paper.

The number of drawing pencils on the market is so numerous that only those suitable for drawing and designing will be given consideration. The Koh-i-noor pencils have always had the preference and for this work the HB and 2H grades are used with few excep-

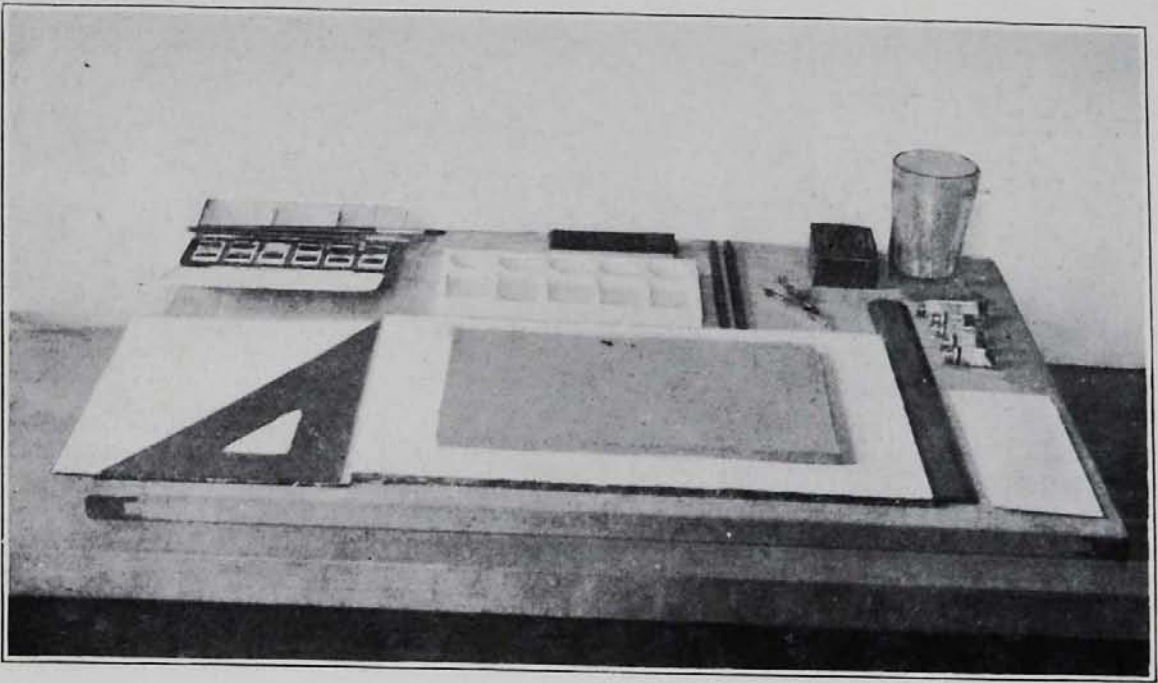


FIGURE 215

tions, the Venus HB and the H, however, are good substitutes when the former cannot be had. Some device for sharpening the pencil point while at work should be devised. A pad of No. 1 sand paper will serve this purpose.

Brushes for jewelry designing should be chosen with all the discrimination that the student is capable of exercising since they make for good or for bad results. The best brushes for this work are Sable Brushes. These brushes come in various sizes designated by a number on the handle; e. g., the smaller the number the smaller the brush. For laying on flat washes over the whole sheet a number 5 or 6 brush is used and for the rendering numbers 1 and 2 are used. The size of the design usually suggests the brush to be employed so that at times larger brushes than those mentioned will save time if they can be used. The brushes, however, must be in a perfect condition, i. e., the hair must come together to a point when slightly moistened; this is one test the brush should be subjected to before buying. The brush should never be clipped with the scissors to adjust it. If the hair refuses to come together to

a natural point it indicates that the brush is worn and must be replaced.

The fact that the expensive colors are readily soluble and fade very little with time makes them the cheapest in the end. Moist colors in the tubes are better than those in the cake form, although the latter have been used with good results. Such colors as Chinese white, charcoal gray, pale cadmium, gamboge, emerald green, cobalt blue, vermilion, alizarin crimson and veridian would furnish an adequate assortment although more could be added to make up a more elaborate set. If the cake form is used, such boxes as Talens No. 7 or with the addition of Chinese white and pale cadmium in the tubes will make up a less expensive equipment. The recesses in the water color boxes, or a nest of cabinet saucers, of a sloping tier of five or six divisions will furnish a good pallet for mixing the paint. Unless the water color box has a compartment for holding water, an ordinary glass makes a good receptacle for a mixing medium.

For erasing, the emerald eraser does well for line work, while art gum is employed for general cleaning. By virtue of its composition the design is rubbed to a grayness while all the finger marks are completely removed and the surface of the paper is left intact. This is very desirable for color work.

If a whole set of mechanical drawing instruments cannot be afforded a good steel or boxwood scale and a small compass will serve their place from time to time.

Fig. 168, Page 247, illustrates an inexpensive table which might be made at a moderate cost. A more comfortable but expensive table is one with an adjustable top fitted to a cast iron standard.

Jewelry Coloring

DESIGNS rendered in color show the kind of finish a piece of jewelry is to have, indicating whether it is to be finished in white, yellow, green or Roman gold, or matted, sand-blasted, or oxidized silver. These shades of color are determined by the designer after a careful study of the color of the stone which is to be mounted. It is important, therefore, that the designer have some knowledge of the colors that can be obtained with chemicals in order that he may design intelligently.

The natural oxidation of silver is due to the presence of sulphur in the atmosphere. This very desirable color may be produced by the use of chemicals in a very short time, with the following solution: one ounce of potassium sulphide to one quart of water. The solution is prepared by bringing the water to a boil, then dropping the sulphide in and allowing it to dissolve. The liquid is more effective if applied when hot to the metal, after it has been thoroughly cleaned. It is best to use a weak solution so that the oxidizing may be produced gradually. The piece of work may be submerged in the solution until the desired color is produced, but if it has a stone that is comparatively soft, it will absorb the solution to such an extent as to ruin it. It is therefore best to apply the solution with a brush. When it has dried, sprinkle a little pumice powder over the piece of work and brush it with a stiff brush until the desired shade of gray is obtained. If the color rubs off too easily, it shows that the solution was too concentrated and if light and dark

spots appear with an uneven appearance, it shows that the work was not thoroughly cleaned before the solution was applied. The color may also be rubbed off the high places by taking a little moist pumice powder on the end of the thumb and working over it till the desired effect is obtained. It is then rinsed and, when dry, rubbed briskly with a cotton flannel or a chamois cloth. The high places should have a bright polish and if more polish than that obtained by the pumice is desired, a powdered rouge or a hand-buff may be used, or, if a polishing lathe is at hand, rub stick rouge on the cotton or felt buff, and polish, being careful not to wear away the high points in the piece of work. Acid solutions used for coloring are best kept in enameled or earthen jars.

Silver jewelry may also be oxidized by using the following preparation: eighteen parts of graphite and three parts of powdered blood-stone mixed with either oil or turpentine. After the piece of work is dry, it is rubbed with a soft brush which is occasionally drawn over wax.

A pleasing brown may be produced by using the following: ten parts of sal-ammoniac, ten parts of blue vitriol and five parts of salt peter mixed together.

A blue-black color may be produced by using sulphide of ammonium and warming the object slightly till the desired shade of blue-black appears. It is then submerged in luke-warm soap water, after which it is rubbed with a soft brush.

Green oxidation may be produced by applying the following solution: three parts hydrochloric acid, one part iodine, one part water. When enough has been applied, that is when the required color is reached, it is thoroughly rinsed and well dried. If possible, the piece of work should be left in the solution till the desired color is obtained. If the piece of jewelry has much relief work, the high places may be rubbed and polished, and then the green oxide may be again applied

in the low parts only, until a beautiful green color is the result.

One ounce of liquid platinum, mixed with several gallons of water, will make a very rich gray for silver work. Although expensive, it gives a very uniform and durable finish.

Polishing powder for jewelry may be made by mixing fifteen parts oxide of iron, eighty-six parts of carbonate of magnesia, and twenty parts of washed American Tripoli.